



Professional Tools and Equipment





Rugged and Reliable

Table of Contents

Table of Contents

Screwdrivers, Nut Drivers, Pry Bars	3-7
Standard (black, red, orange, green) and Professional Series Screwdrivers, Torq Screwdrivers, Nut Drivers, Hex Bits, Pry Bars (bent head, rolling head)	
Sockets and Drive Tools	8-35
Chrome Sockets, Impact Sockets, Spline Sockets, Crowsfoot, Torx Sockets (internal /external), Flip Sockets, Spindle Nut Sockets, Hex Bit Sockets, Spark Plug Sockets, Universal Joints, Adapters, Reducers, Extensions, Ratchets, Breaker Bars, T-handle, Spinner Handles	
Wrenches	36-50
Raised Panel Combination, High Polish Combination, Stubby, Flare Nut, Ratcheting Box, Ratcheting Combination and Reversible Ratcheting, Adjustable Wrenches, Pipe Wrenches, Aluminum Pipe Wrenches, Allen/Hex Wrenches	
Pliers, Hammers, Punches, Chisels, and Files	51-56
Needle Nose, Diagonal, Slip Joint, Groove Joint, Locking, Snap Ring, Ball Pein Hammers, Claw Hammer, Rubber Mallet, Brass Hammers, Files, Taper Punches, Center Punches, Pin Punches, Chisel, and Brass Punches	
Specialty Tools	57-86
Tow Straps / Tie Downs, Brushes, Q-Bond Adhesive, Adhesive Tape, Measuring Tapes, Scrapers, Knives / Cutting Tools, Bolt Cutters, Riveters, Brake Tools, Hooks/Picks, Magnets and Mirrors, Specialty Pliers, Circuit Testers, Belt Tools, Barrel Pumps, Funnels, Filter Wrenches and Pliers, Flaring Tools, Pullers, Service Sets, and Torches	
Brake, Tire, Wheel and TPMS	87-98
Brake Tools and Service Sets, Accutorg Torque Sticks and Sets, Torque Wrenches, Tire Inflators and Gauges, Tire Repair, TPMS Sensor Activation Tools and Service Tools	
Lighting	99-108
Extension Cords and Reels, Drop Lights, Fluorescent Lights, LED Lights, Halogen Lights	
Battery Testers and Booster Cables	109-112
Battery Tools, Portable Power, Wheeled Chargers, Carried Chargers, Cables, Clamps	
Creepers, Carts, and Tool Storage	113-119
Creepers, Creeper Seats, Service Carts, Magnetic Tool Storage and Organization	
Shop Equipment	120-131
Bench Grinder, Steel Vises, Bottle Jacks, Jack Stands, Engine Stands, Engine Crane, Rams, Trolley Jack, Service/Floor Jacks, Transmission Jacks, Hydraulic Presses, Trolley Jacks, Pallet Jack, Body Repair Kits, Parts Washers	
Air Tools, Electric Tools and PBE Tools	132-146
Air Impacts, Ratchets, Die Grinders, Drills, Hammers, Sanders, Polishers, Rivet Guns, Spray Guns, Electric Grinder, Electric Polishers, Pneumatic Bits, Bit Sets, Drill Bits, Drill Chucks, Abrasive Discs, Cut Off Wheels, Sander Pads, Regulators, Air Hose, Grinding Wheels	
Electrical and Hardware Components	147-174
Nylon Ties, Wire Strippers, Body Clip Pliers, Hose Clamp Pliers, Fuse Puller, Terminals, Wire Loom, Wire Clips, Primary Wire, Wire Connectors, Cable Clamps, Fuses (ATO, ATM, Maxi, Glo, Low Profile, Jcase, Glass, Copper Lugs, Shrink Connectors/Terminals, Solderless Terminals, Heat Shrink Tubing, Vacuum Caps/Tees, Grease Fittings, Drain Plugs and Gaskets, Brake Line, Brake Line Fittings, Adapters and Unions, Fuel Line, Fuel Line Repair Kits, Fuel Line Connectors, Clips, Adapters, Fuel Line Tools for Connecting and Installing, Service Kits, Hardware Kits (hitch pin, e-clip, cotter pins, snap rings, fuses, hex washers, o-rings, copper washers, grease fittings, roll pins, terminals).	
Displays and Merchandisers	175-192
Index by Part Number	193-202
Index by Category	203-207
Warranty Information	208-209
Safety Information	210

Icon Legend

Product is proudly made in the USA
Product is 1/4-inch drive
Product is 3/8-inch drive
Product is 1/2-inch drive
Product is 3/4-inch drive
Product is 1-inch drive
Product has 6 internal points of contact
Product has 12 internal points of contact
Repair or replacement parts are available
Product is also sold individually
Product is covered by lifetime warranty
Oversized product ships via freight company



Screwdrivers, Nut Drivers, Pry Bars

Screwdrivers, Nut Drivers, Pry Bars

KTI19000 8-Piece Black Screwdriver Set

Eight-piece screwdriver set includes: 1# Phillips 3" blade; #2 Phillips 1-1/2" stubby; #2 Phillips 4" blade; stubby slotted; 3" slotted; 4" slotted; 6" slotted; 8" slotted. Tools feature high quality chrome vanadium blades, heavy-duty colored handles and hex bolsters for wrench assist. Packaged with plastic tray. Black handles.

Set includes (also available individually):

KTI19113 - #1 Phillips 3"

KTI19121 - #2 Phillips Stubby

KTI19124 - #2 Phillips 4"

KTI19201 - Stubby slotted

KTI19203 - 3" slotted

KTI19204 - 4" slotted

KTI19206 - 6" slotted

KTI19208 - 8" slotted



KTI19700 8-Piece Orange Screwdriver Set

Eight-piece screwdriver set includes: 1# Phillips 3" blade; #2 Phillips 1-1/2" stubby; #2 Phillips 4" blade; stubby slotted; 3" slotted; 4" slotted; 6" slotted; 8" slotted. Tools feature high quality chrome vanadium blades, heavy-duty colored handles and hex bolsters for wrench assist. Packaged with plastic tray. Orange handles.

Set includes (also available individually):

KTI19713 - #1 Phillips 3"

KTI19721 - #2 Phillips Stubby

KTI19724 - #2 Phillips 4"

KTI19701 - Stubby slotted

KTI19703 - 3" slotted

KTI19704 - 4" slotted

KTI19706 - 6" slotted

KTI19708 - 8" slotted



KTI19800 8-Piece Red Screwdriver Set

Eight-piece screwdriver set includes: 1# Phillips 3" blade; #2 Phillips 1-1/2" stubby; #2 Phillips 4" blade; stubby slotted; 3" slotted; 4" slotted; 6" slotted; 8" slotted. Tools feature high quality chrome vanadium blades, heavy-duty colored handles and hex bolsters for wrench assist. Packaged with plastic tray. Red handles.

Set includes (also available individually):

KTI19813 - #1 Phillips 3"

KTI19821 - #2 Phillips Stubby

KTI19824 - #2 Phillips 4"

KTI19801 - Stubby slotted

KTI19803 - 3" slotted

KTI19804 - 4" slotted

KTI19806 - 6" slotted

KTI19808 - 8" slotted



KTI19900 8-Piece Green Screwdriver Set

Eight-piece screwdriver set includes: 1# Phillips 3" blade; #2 Phillips 1-1/2" stubby; #2 Phillips 4" blade; stubby slotted; 3" slotted; 4" slotted; 6" slotted; 8" slotted. Tools feature high quality chrome vanadium blades, heavy-duty colored handles and hex bolsters for wrench assist. Packaged with plastic tray. Green handles.

Set includes (also available individually):

KTI19913 - #1 Phillips 3"

KTI19921 - #2 Phillips Stubby

KTI19924 - #2 Phillips 4"

KTI19901 - Stubby slotted

KTI19903 - 3" slotted

KTI19904 - 4" slotted

KTI19906 - 6" slotted

KTI19908 - 8" slotted



KTI16000 10-Piece Professional Screwdriver Set

Ten-piece professional screwdriver set includes the perfect assortment of slotted and Phillips screwdrivers for a variety of projects. Tools feature comfortable triangular grip, non-slip material and chrome vanadium blades. Ultimate professional quality. Includes: 3" slotted, 4" slotted, 6" slotted, 8" slotted and 1-1/2" stubby slotted and #1 Phillips, #3 Phillips, #2 x 4" Phillips, #2 x 10" Phillips and 1-1/2" stubby Phillips. Also sold in 5-piece slotted set, 5-piece Phillips set or individually.

Available in sets or individually:

KTI16001 - 5-piece Slotted Set

KTI16201 - stubby slotted

KTI16203 - 3" slotted

KTI16204 - 4" slotted

KTI16206 - 6" slotted

KTI16208 - 8" slotted



KTI16002 - 5-piece Phillips Set

KTI16113 - #1 Phillips 3"

KTI16121 - #2 Phillips Stubby 1.5"

KTI16124 - #2 Phillips 4"

KTI16129 - #2 Phillips 10"

KTI16136 - #3 Phillips 6"

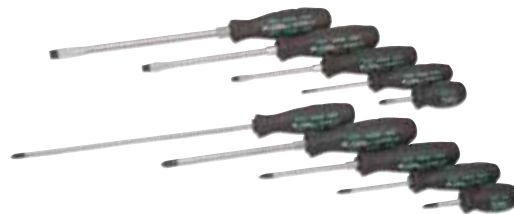



KT111035

34 Piece Screwdriver Set

Set includes: 7 Phillips (#3x6", #2x4", #1x6", #1x3", #0x4", #0x3", #2x1-1/2"), 8 Slotted (5/16"x6", 1/4"x4", 3/16"x6", 3/16"x3", 5/32"x4", 1/8"x4", 1/8"x3", 1/4"x1-1/2"), 4 Torx (T10x4", T15x4", T20x4", T25x4"), 2 Square (S1x4", S2x4"), Bits Driver, 12 Bits (4 Slotted 1/8", 5/32", 3/16", 1/4"; 4 Phillips #0, #1, #2, #3; 4 Torx T10, T15, T20, T25)

KT111226 Phillips #3 x 6"	KT111006 Slotted 3/16" x 6"	KT111225 Torx T25 x 4"	KT118901 Phillips #1
KT111224 Phillips #2 x 4"	KT111012 Slotted 3/16" x 3"	KT111001 Square S1" x 4"	KT118902 Phillips #2
KT111230 Phillips #1 x 6"	KT111005 Slotted 5/32" x 4"	KT111002 Square S2" x 4"	KT118903 Phillips #3
KT111223 Phillips #1 x 3"	KT111004 Slotted 1/8" x 4"	KT118009 Bits Driver	KT118910 Torx T10
KT111231 Phillips #0 x 4"	KT111003 Slotted 1/8" x 3"	KT118904 Slotted 1/8"	KT118915 Torx T15
KT111229 Phillips #0 x 3"	KT111010 Slotted 1/4" x 1-1/2"	KT118905 Slotted 5/32"	KT118920 Torx T20
KT111221 Phillips #2 x 1-1/2"	KT111211 Torx T10 x 4"	KT118906 Slotted 3/16"	KT118925 Torx T25
KT111009 Slotted 5/16" x 6"	KT111215 Torx T15 x 4"	KT118907 Slotted 1/4"	
KT111011 Slotted 1/4" x 4"	KT111220 Torx T20 X 4"	KT118900 Phillips #0	

KT111018

18 Piece Screwdriver Set

Includes: 4 Slotted (5/16"x6", 1/4"x4", 3/16"x3", 1/4"x1-1/2"), 4 Phillips (#3x6", #2x4", #1x3", #2x1-1/2"), 10 Precision (6 Torx T5x1-9/16", T6x1-9/16", T7x1-9/16", T8x1-9/16", T9x1-9/16", T10x1-9/16"; 2 Slotted 3/32"x1-9/16", 1/8"x1-9/16"; 2 Phillips #0x1-9/16", #00x1-9/16")



KT111009 Slotted 5/16" x 6"	KT111206 Torx Precision T6 x 1-9/16"
KT111011 Slotted 1/4" x 4"	KT111207 Torx Precision T7 x 1-9/16"
KT111012 Slotted 3/16" x 3"	KT111208 Torx Precision T8 x 1-9/16"
KT111010 Slotted 1/4" x 1-1/2"	KT111209 Torx Precision T9 x 1-9/16"
KT111226 Phillips #3 x 6"	KT111210 Torx Precision T10 x 1-9/16"
KT111224 Phillips #2 x 4"	KT111201 Slotted Precision 3/32" x 1-9/16"
KT111223 Phillips #1 x 3"	KT111202 Slotted Precision 1/8" x 1-9/16"
KT111221 Phillips #2 x 1-1/2"	KT111203 Phillips Precision #0 x 1-9/16"
KT111205 Torx Precision T5 x 1-9/16"	KT111204 Phillips Precision #00 x 1-9/16"

KT111008

8 Piece Screwdriver Set

- Made of Chrome Vanadium steel
- Set includes: 4 Slotted (5/16"x6", 3/16"x4", 1/8"x3", 1/4"x1-1/2"), 4 Phillips (#2x6", #1x4", #0x3", #2x1-1/2")

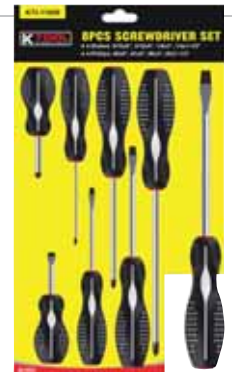

KT111009 Slotted 5/16" x 6"	KT111227 Phillips #2 x 6"
KT111007 Slotted 3/16" x 4"	KT111228 Phillips #1 x 4"
KT111003 Slotted 1/8" x 3"	KT111229 Phillips #0 x 3"
KT111010 Slotted 1/4" x 1-1/2"	KT111221 Phillips #2 x 1-1/2"



KT172180

1/4" Female Adjustable Torque Screwdriver

- Screwdriver handle contains viewable torque scale 5-40 inch-pounds (.504 Nm)
- 1/4" Female hex
- Heavy duty black plastic storage case included



KT119138

8" Black Screwdriver #4 Phillips



KT111110

Pocket Screwdriver

- 5-3/16" length
- 1/8" blade width
- Easy to grip handle
- Polished steel

Screwdrivers, Nut Drivers, Pry Bars

KT111100

Interchangeable Screwdriver Set

Screwdriver set features three dual-sided interchangeable inserts - 3 slotted, 3 phillips bits. Includes: #1 phillips and 3/16" slotted; #2 phillips and 1/4" slotted; #3 phillips and 5/16" slotted. Rubber o-ring provides a secure, non-slip grip. Each screwdriver bit boasts a 2-5/8" blade at each end (6" overall bit length) and a hex bolster for wrench assist (7/16" fractional or 11mm metric). Set includes storage pouch for convenience and flexibility. Plastic contoured handle for maximum torque and comfort. Anodized alloy shank for high durability.



LIFETIME WARRANTY*

KT114219

19-inch Jumbo Screwdriver

Features a 19" x 1/2" blade. Extra large handles and shafts for use on hard to reach areas of large machinery, farm equipment, manufacturing equipment, automobiles and more. Square shank allows for use with wrenches for larger torque jobs. Black oxide finish. Made in U.S.A.



MADE IN USA

LIFETIME WARRANTY*

KT114400 7-Piece Fractional Nut Driver Set

Seven-piece professional fractional nut driver set includes sizes: 3/16" x 3", 1/4" x 3", 5/16" x 3", 11/32" x 3", 3/8" x 3", 7/16" x 3" and 1/2" x 3". Rugged and designed for shop environments, tools feature hollow shafts, ergonomic soft grip handles, and alloy steel sockets and shafts. Set is color coded for easy identification. Tools packaged in handy plastic hanging organizer. Available individually.



Set includes (also available individually):

KT114406 - 3/16" x 3"

KT114408 - 1/4" x 3"

KT114410 - 5/16" x 3"

KT114411 - 11/32" x 3"

KT114412 - 3/8" x 3"

KT114414 - 7/16" x 3"

KT114416 - 1/2" x 3"



LIFETIME WARRANTY*

Torq Screwdrivers

Large grip handle and chrome vanadium blades make light work of headlight and trim screws.



Sold separately:

KT111310 - T10 Torq screwdriver

KT111315 - T15 Torq screwdriver

KT111320 - T20 Torq screwdriver

LIFETIME WARRANTY*

KT114500 7-Piece Metric Nut Driver Set

Seven-piece professional metric nut driver set includes sizes: 5 mm x 75, 6 mm x 75, 7 mm x 75, 8 mm x 75, 9 mm x 75, 10 mm x 75 and 11 mm x 75. Rugged and designed for shop environments, tools feature hollow shafts, ergonomic soft grip handles, and alloy steel sockets and shafts. Set is color coded for easy identification. Tools packaged in handy plastic hanging organizer. Available individually.



Set includes (also available individually):

KT114505 - 5mm x 75mm

KT114506 - 6mm x 75mm

KT114507 - 7mm x 75mm

KT114508 - 8mm x 75mm

KT114509 - 9mm x 75mm

KT114510 - 10mm x 75mm

KT114511 - 11mm x 75mm



LIFETIME WARRANTY*

Hex Bits - 5/16" Shank

Bits are designed to be used with impact drivers or for use in sockets. Available in five sizes.



Sold separately:

KT118801 - small slotted

KT118802 - large slotted

KT118920 - T-20 bit (1/4" shank)

KT118702 - #2 Phillips

KT118703 - #3 Phillips

LIFETIME WARRANTY*



**KTI10330
326-Piece
Master Drill Bit Set**

KTI's Master Drill Bit is a comprehensive set of drill bits and accessories. This 326-piece set includes bits and accessories for nearly every job. The unique storage case fully opens to access the bit and accessories you need. Two (2) bottom trays fold and slide into portable carrying case. Transport from job to job quickly and easily!

Qty:	Description	Qty:	Description
64	HSS Twist Drill Bits: 3/64" (8), 1/16" (8), 5/64" (5), 3/32" (5), 7/64" (5), 1/8" (5), 9/64" (5), 5/32" (5), 3/16" (4), 7/32" (4), 15/64", 1/4", 17/64", 9/32", 5/16", 11/32", 3/8", 7/16", 15/32" and 1/2"	6	Drill Stoppers: 1/8", 5/32", 3/16", 1/4", 5/16" and 3/8"
54	Titanium Coated High Speed Drill Bits: 3/64" (6), 1/16" (6), 5/64" (4), 3/32" (4), 7/64" (4), 1/8" (4), 9/64" (4), 5/32" (4), 11/64" (4), 3/16" (2), 7/32" (2), 15/64", 1/4", 17/64", 9/32", 5/16", 11/32", 3/8", 7/16", 15/32" and 1/2"	1	Allen Key - 2.5mm
10	Nutdrivers: 5/32", 3/16", 7/32", 1/4", 9/32", 5/16", 11/32", 3/8", 7/16" and 1/2"	1	Magnetic Holder
37	2" Screwdriver Bits: 7 Slotted, 6 Phillips, 6 Pozzi, 8 Star, 7 Metric Hex and 8 Square	1	Counter Sink Gauge
64	1" Screwdriver Bits: 14 Slotted, 10 Phillips, 10 Pozzi, 8 Star, 7 Hex, 9 Metric Hex and 6 Square	1	Hole Saws: 1 3/4", 2-1/8", 2-3/8" and 2 1/2"
3	14" Masonry Drill Bits: 5/16", 3/8" and 1/2"	44	Hole Saw Adapter
21	Masonry Drill Bits: 5/32" (2), 11/64" (2), 3/16" (2), 7/32" (2), 15/64" (2), 1/4" (2), 17/64", 9/32", 5/16", 21/64", 11/32", 3/8", 7/16", 15/32" and 1/2"	5	Wood Boring Drill Bits: 1/8" (3), 5/32" (4), 11/64" (8), 3/16" (4), 13/64" (4), 7/32" (4), 15/64" (4), 1/4" (4), 17/64", 9/32", 5/16", 11/32", 3/8", 7/16", 15/32" and 1/2"
4	Nail Pouch: 1/32", 1/16", 3/32" and 1/8"	4	Flat Wood Bits: 1/2", 5/8", 3/4", 7/8" and 1 1/4"
			12" Flat Wood Bits: 5/16", 3/8", 1/2" and 9/16"

**KTI19240
4-Piece Pry Bar Set**

Four-piece bent-end pry bar set includes: 9", 12", 18", 24". Tools feature smooth, comfortable square handles. Packaged in plastic formed box. Available individually.

Set includes (also available individually):

- KTI19209** - 9" **KTI19212** - 12"
- KTI19218** - 18" **KTI19224** - 24"



**KTI71600
4-Piece Pry Bar Set**

Superior quality, heat-treated pry bars. Tools feature high leverage rolling head and long tapered body to align drift. Includes 6", 12", 16" and 20" pry bars.

Set includes (also available individually):

- KTI71606** - 6" **KTI71612** - 12"
- KTI71616** - 16" **KTI71620** - 20"





Sockets and Drive Tools



1/4" Drive | CHROME

1/4 Inch Drive Fractional and Metric Chrome Sockets			KTI21000	KTI21044	KTI21100	KTI21200	KTI26000	KTI26100	KTI26200
6-POINT SHORT FRACTIONAL	3/16"	KTI21106	•	•	•				
	7/32"	KTI21107	•	•	•				
	1/4"	KTI21108	•	•	•				
	9/32"	KTI21109	•	•	•				
	5/16"	KTI21110	•	•	•				
	11/32"	KTI21111	•	•					
	3/8"	KTI21112	•	•	•				
	7/16"	KTI21114	•	•	•				
	1/2"	KTI21116	•	•	•				
6-POINT DEEP FRACTIONAL	9/16"	KTI21118		•					
	3/16"	KTI21206							
	7/32"	KTI21207				•			
	1/4"	KTI21208	•	•		•			
	9/32"	KTI21209	•	•		•			
	5/16"	KTI21210	•	•		•			
	11/32"	KTI21211	•	•		•			
	3/8"	KTI21212	•	•		•			
	7/16"	KTI21214	•	•		•			
6-POINT SHORT METRIC	1/2"	KTI21216	•	•		•			
	9/16"	KTI21218		•					
	4mm	KTI26104		•			•		
	5mm	KTI26105		•			•		
	5.5mm	KTI26155		•			•		
	6mm	KTI26106		•			•	•	
	7mm	KTI26107		•			•	•	
	8mm	KTI26108		•			•	•	
	9mm	KTI26109		•			•	•	
	10mm	KTI26110		•			•	•	
	11mm	KTI26111		•			•	•	
	12mm	KTI26112		•			•	•	
	13mm	KTI26113		•			•	•	
	14mm	KTI26114		•			•	•	
	6-POINT DEEP METRIC	15mm	KTI26115		•			•	•
5.5mm		KTI26255					•		
6mm		KTI26206		•			•	•	
7mm		KTI26207		•			•	•	
8mm		KTI26208		•			•	•	
9mm		KTI26209		•			•	•	
10mm		KTI26210		•			•	•	
11mm		KTI26211		•			•	•	
12mm		KTI26212		•			•	•	
13mm		KTI26213		•			•	•	
14mm		KTI26214		•			•	•	
15mm	KTI26215		•			•	•		

INDIVIDUAL SOCKETS

All sockets listed individually or as part of a display ship on a hangtag. Each tag is clearly marked with the drive size, socket size and other important information.

Each hangtag is barcoded for point-of-sale scanning and inventory control.

Hangtags are a perfect way to merchandize and organize sockets in order to locate and replenish stock quickly and easily.



Sockets and Drive Tools

3/8" Drive CHROME

3/8 Inch Drive Fractional Chrome Sockets 6-point		KTI22000	KTI22047	KTI22100	KTI22202
6-POINT SHORT FRACTIONAL	1/4"	KTI22108		•	
	5/16"	KTI22110		•	•
	3/8"	KTI22112	•	•	•
	7/16"	KTI22114	•	•	•
	1/2"	KTI22116	•	•	•
	9/16"	KTI22118	•	•	•
	5/8"	KTI22120	•	•	•
	11/16"	KTI22122	•	•	•
	3/4"	KTI22124	•	•	•
	13/16"	KTI22126	•	•	•
	7/8"	KTI22128	•	•	•
	15/16"	KTI22130			
	1"	KTI22132			
6-POINT DEEP FRACTIONAL	1/4"	KTI22208			
	5/16"	KTI22210			
	3/8"	KTI22212	•	•	•
	7/16"	KTI22214	•	•	•
	1/2"	KTI22216	•	•	•
	9/16"	KTI22218	•	•	•
	5/8"	KTI22220	•	•	•
	11/16"	KTI22222	•	•	•
	3/4"	KTI22224	•	•	•
	13/16"	KTI22226	•	•	•
7/8"	KTI22228		•	•	
15/16"	KTI22230				
1"	KTI22232				
SPARK PLUG	5/8" Extra Deep	KTI22219			
	5/8" (carded)	KTI22221			
	13/16" (carded)	KTI22227			
	5/8" (bulk)	KTI22521			
	13/16" (bulk)	KTI22527			

3/8 Inch Drive Fractional Chrome Sockets 12-point		KTI20045	KTI22401	KTI22501	KTI22547	
SPLINE SHORT FRACTIONAL	5/16"	KTI20210	•			
	3/8"	KTI20212	•			
	7/16"	KTI20214	•			
	1/2"	KTI20216	•			
	9/16"	KTI20218	•			
	5/8"	KTI20220	•			
	11/16"	KTI20222	•			
	3/4"	KTI20224	•			
	13/16"	KTI20226	•			
	7/8"	KTI20228	•			
	SPLINE DEEP FRACTIONAL	3/8"	KTI20412	•		
		7/16"	KTI20414	•		
		1/2"	KTI20416	•		
9/16"		KTI20418	•			
5/8"		KTI20420	•			
11/16"		KTI20422	•			
3/4"		KTI20424	•			
13/16"		KTI20426	•			
7/8"		KTI20428	•			
1"		KTI22408		•		
12-POINT DEEP FRACTIONAL	5/16"	KTI22410		•		
	3/8"	KTI22412		•	•	
	7/16"	KTI22414		•	•	
	1/2"	KTI22416		•	•	
	9/16"	KTI22418		•	•	
	5/8"	KTI22420		•	•	
	11/16"	KTI22422		•	•	
	3/4"	KTI22424		•	•	
	13/16"	KTI22426		•	•	
	7/8"	KTI22428		•	•	
	15/16"	KTI22430		•		
	1"	KTI22432		•		
	12-POINT SHORT FRACTIONAL	1/4"	KTI22508		•	•
5/16"		KTI22510		•	•	
3/8"		KTI22512		•	•	
7/16"		KTI22514		•	•	
1/2"		KTI22516		•	•	
9/16"		KTI22518		•	•	
5/8"		KTI22520		•	•	
11/16"		KTI22522		•	•	
3/4"		KTI22524		•	•	
13/16"		KTI22526		•	•	
7/8"		KTI22528		•	•	
15/16"		KTI22530		•		
1"		KTI22532		•		



3/8" Drive CHROME



3/8 Inch Drive Metric Chrome Sockets 6-point		KTI2047	KTI27000	KTI27100	KTI27201	
6-POINT SHORT METRIC	6mm	KTI27106	•			
	7mm	KTI27107	•		•	
	8mm	KTI27108	•	•	•	
	9mm	KTI27109	•	•	•	
	10mm	KTI27110	•	•	•	
	11mm	KTI27111	•	•	•	
	12mm	KTI27112	•	•	•	
	13mm	KTI27113	•	•	•	
	14mm	KTI27114	•	•	•	
	15mm	KTI27115	•	•	•	
	16mm	KTI27116	•	•	•	
	17mm	KTI27117	•	•	•	
	18mm	KTI27118	•	•	•	
	19mm	KTI27119	•	•	•	
	20mm	KTI27120		•		
	21mm	KTI27121		•		
	22mm	KTI27122				
	23mm	KTI27123				
	24mm	KTI27124				
	25mm	KTI27125				
	26mm	KTI27126				
	6-POINT DEEP METRIC	6mm	KTI27206			
		7mm	KTI27207			
		8mm	KTI27208			
		9mm	KTI27209			
		10mm	KTI27210	•	•	•
11mm		KTI27211	•	•	•	
12mm		KTI27212	•	•	•	
13mm		KTI27213	•	•	•	
14mm		KTI27214	•	•	•	
15mm		KTI27215	•		•	
16mm		KTI27216	•	•	•	
17mm		KTI27217	•	•	•	
18mm	KTI27218	•	•	•		
19mm	KTI27219	•	•			
20mm	KTI27220					
21mm	KTI27221					
22mm	KTI27222					
23mm	KTI27223					
24mm	KTI27224					
25mm	KTI27225					
26mm	KTI27226					

3/8 Inch Drive Metric Chrome Sockets 12-point		KTI20045	KTI22401	KTI22501	KTI22547
SPLINE SHORT METRIC	10mm	KTI20310	•		
	11mm	KTI20311	•		
	12mm	KTI20312	•		
	13mm	KTI20313	•		
	14mm	KTI20314	•		
	15mm	KTI20315	•		
	16mm	KTI20316	•		
	17mm	KTI20317			
	18mm	KTI20318	•		
	19mm	KTI20319	•		
SPLINE DEEP METRIC	7mm	KTI20707	•		
	8mm	KTI20708	•		
	9mm	KTI20709	•		
	10mm	KTI20710	•		
	11mm	KTI20711	•		
	12mm	KTI20712	•		
	13mm	KTI20713	•		
	14mm	KTI20714	•		
	15mm	KTI20715	•		
	16mm	KTI20716	•		
17mm	KTI20717	•			
18mm	KTI20718	•			
19mm	KTI20719	•			
12-POINT DEEP METRIC	7mm	KTI27407		•	
	8mm	KTI27408		•	
	9mm	KTI27409		•	
	10mm	KTI27410		•	•
	11mm	KTI27411		•	•
	12mm	KTI27412		•	•
	13mm	KTI27413		•	•
	14mm	KTI27414		•	•
	15mm	KTI27415		•	•
	16mm	KTI27416		•	•
	17mm	KTI27417		•	•
	18mm	KTI27418		•	•
19mm	KTI27419		•	•	
20mm	KTI27420		•		
21mm	KTI27421		•		
12-POINT SHORT METRIC	6mm	KTI27506			•
	7mm	KTI27507			•
	8mm	KTI27508			•
	9mm	KTI27509			•
	10mm	KTI27510			•
	11mm	KTI27511			•
	12mm	KTI27512			•
	13mm	KTI27513			•
	14mm	KTI27514			•
	15mm	KTI27515			•
	16mm	KTI27516			•
	17mm	KTI27517			•
18mm	KTI27518			•	
19mm	KTI27519			•	
20mm	KTI27520			•	
21mm	KTI27521			•	

Sockets and Drive Tools

1/2" Drive CHROME



1/2 Inch Drive Fractional Chrome Sockets		KT123000	KT123110	KT123200	KT123800
6-POINT SHORT FRACTIONAL	3/8"	KT123112			
	7/16"	KT123114	•	•	
	1/2"	KT123116	•	•	
	9/16"	KT123118	•	•	
	5/8"	KT123120	•	•	
	11/16"	KT123122	•	•	
	3/4"	KT123124	•	•	
	13/16"	KT123126	•	•	
	7/8"	KT123128	•	•	
	15/16"	KT123130	•	•	
	1"	KT123132	•	•	
	1-1/16"	KT123134	•	•	
	1-1/8"	KT123136	•	•	
	1-1/4"	KT123140	•	•	
	1-5/16"	KT123142			
	1-3/8"	KT123144			
	1-7/16"	KT123146			
1-1/2"	KT123148				
12-POINT	3/8" short	KT123512			
	1/2"	KT123516			
6-POINT DEEP FRACTIONAL	7/16"	KT123214			
	1/2"	KT123216			•
	9/16"	KT123218			•
	5/8"	KT123220			•
	11/16"	KT123222			•
	3/4"	KT123224			•
	13/16"	KT123226			•
	7/8"	KT123228			•
	15/16"	KT123230			•
	1"	KT123232			•
	1-1/16"	KT123234			
	1-1/8"	KT123236			
	1-1/4"	KT123240			
	1-5/16"	KT123242			
	1-3/8"	KT123244			
	1-7/16"	KT123246			
	1-1/2"	KT123348			
STUD REMOVERS	14"	KT123808			•
	5/16"	KT123810			•
	3/8"	KT123812			•
	7/16"	KT123814			•

1/2 Inch Drive Metric Chrome Sockets		KT128000	KT128100	KT128200	KT128206	KT123900
6-POINT SHORT METRIC	10mm	KT128110				
	11mm	KT128111				
	12mm	KT128112				
	13mm	KT128113				
	14mm	KT128114				
	15mm	KT128115	•	•		
	16mm	KT128116	•	•		
	17mm	KT128117	•	•		
	18mm	KT128118	•	•		
	19mm	KT128119	•	•		
	20mm	KT128120	•	•		
	21mm	KT128121	•	•		
	22mm	KT128122	•	•		
	23mm	KT128123	•	•		
	24mm	KT128124	•	•		
	25mm	KT128125	•	•		
	26mm	KT128126	•	•		
	27mm	KT128127	•	•		
	28mm	KT128128	•	•		
	6-POINT DEEP METRIC	10mm	KT128210			
11mm		KT128211				
12mm		KT128212				
13mm		KT128213				
14mm		KT128214				
15mm		KT128215			•	
16mm		KT128216			•	
17mm		KT128217			•	
18mm		KT128218			•	
19mm		KT128219			•	
20mm		KT128220			•	
21mm		KT128221			•	
22mm		KT128222			•	
23mm		KT128223			•	
24mm		KT128224			•	
25mm		KT128225				
26mm		KT128226				
27mm	KT128227					
28mm	KT128228					
29mm	KT128229				•	
SPINDLE NUT	30mm	KT128230				•
	32mm	KT128232				•
	34mm	KT128234				•
	35mm	KT128235				•
	36mm	KT128236				•
	6mm	KT123906				•
STUD REMOVERS	8mm	KT123908				•
	10mm	KT123910				•
	12mm	KT123912				•



3/4" Drive CHROME



3/4 Inch Drive Fractional Chrome Sockets		KT124105	KT124121
6-POINT SHORT FRACTIONAL	3/4"	KT124124	•
	7/8"	KT124128	•
	15/16"	KT124130	•
	1"	KT124132	•
	1-1/16"	KT124134	•
	1-1/8"	KT124136	•
	1-3/16"	KT124138	•
	1-1/4"	KT124140	•
	1-5/16"	KT124142	•
	1-3/8"	KT124144	•
	1-7/16"	KT124146	•
	1-1/2"	KT124148	•
	1-5/8"	KT124152	•
	1-3/4"	KT124156	•
	1-7/8"	KT124160	•
	2"	KT124164	•
	2-1/16"	KT124166	•
	2-1/8"	KT124168	•
	2-3/16"	KT124170	•
	2-1/4"	KT124172	•
2-3/8"	KT124176	•	
12-Point	2-1/4"	KT124173	

3/8" Drive | IMPACT



		3/8 Inch Drive Fractional Impact Sockets				
		KT132100	KT132200	KT132400	KT132500	KT137042
6-POINT SHORT FRACTIONAL	5/16"	KT132110				•
	3/8"	KT132112	•			•
	7/16"	KT132114	•			•
	1/2"	KT132116	•			•
	9/16"	KT132118	•			•
	5/8"	KT132120	•			•
	11/16"	KT132122	•			•
	3/4"	KT132124	•			•
	13/16"	KT132126	•			
	7/8"	KT132128	•			
6-POINT DEEP FRACTIONAL	5/16"	KT132210				•
	3/8"	KT132212		•		•
	7/16"	KT132214		•		•
	1/2"	KT132216		•		•
	9/16"	KT132218		•		•
	5/8"	KT132220		•		•
	11/16"	KT132222		•		•
	3/4"	KT132224		•		•
	13/16"	KT132226		•		
	7/8"	KT132228		•		
6-POINT DEEP FLEX FRACTIONAL	7/16"	KT132414		•		
	1/2"	KT132416		•		
	9/16"	KT132418		•		
	5/8"	KT132420		•		
	11/16"	KT132422		•		
6-POINT SHORT FLEX FRACTIONAL	3/4"	KT132424		•		
	7/16"	KT132514			•	
	1/2"	KT132516			•	
	9/16"	KT132518			•	
	5/8"	KT132520			•	
6-POINT SHORT FLEX FRACTIONAL	11/16"	KT132522			•	
	3/4"	KT132524			•	

		3/8 Inch Drive Metric Impact Sockets				
		KT137042	KT137100	KT137200	KT137400	KT137500
6-POINT SHORT METRIC	8mm	KT137108	•			
	9mm	KT137109	•			
	10mm	KT137110	•	•		
	11mm	KT137111	•	•		
	12mm	KT137112	•	•		
	13mm	KT137113	•	•		
	14mm	KT137114	•	•		
	15mm	KT137115	•	•		
	16mm	KT137116	•	•		
	17mm	KT137117	•	•		
6-POINT DEEP METRIC	18mm	KT137118	•	•		
	19mm	KT137119	•	•		
	8mm	KT137208	•			
	9mm	KT137209	•			
	10mm	KT137210	•		•	
	11mm	KT137211	•		•	
	12mm	KT137212	•		•	
	13mm	KT137213	•		•	
	14mm	KT137214	•		•	
	15mm	KT137215	•		•	
6-POINT DEEP FLEX METRIC	16mm	KT137216	•		•	
	17mm	KT137217	•		•	
	18mm	KT137218	•		•	
	19mm	KT137219	•		•	
	10mm	KT137410				•
	11mm	KT137411				•
	12mm	KT137412				•
	13mm	KT137413				•
	14mm	KT137414				•
	15mm	KT137415				•
6-POINT SHORT FLEX METRIC	16mm	KT137416				•
	17mm	KT137417				•
	18mm	KT137418				•
	19mm	KT137419				•
	10mm	KT137510				•
	11mm	KT137511				•
	12mm	KT137512				•
	13mm	KT137513				•
	14mm	KT137514				•
	15mm	KT137515				•

Sockets and Drive Tools

1/2" Drive | IMPACT

1/2 Inch Drive Fractional Impact Sockets			KTI33100	KTI33101	KTI33104	KTI33200	KTI33202	KTI33204	KTI33500
6-POINT SHORT FRACTIONAL	3/8"	KTI33112		•					
	7/16"	KTI33114		•					
	1/2"	KTI33116	•	•					
	9/16"	KTI33118	•	•					
	5/8"	KTI33120	•	•					
	11/16"	KTI33122	•	•					
	3/4"	KTI33124	•	•					
	13/16"	KTI33126	•	•					
	7/8"	KTI33128	•	•					
	15/16"	KTI33130	•	•					
	1"	KTI33132	•	•					
	1-1/16"	KTI33134	•	•					
	1-1/8"	KTI33136	•	•					
	1-3/16"	KTI33138		•					
	1-1/4"	KTI33140	•	•					
	1-5/16"	KTI33142		•	•				
	1-3/8"	KTI33144		•	•				
	1-7/16"	KTI33146		•	•				
1-1/2"	KTI33148		•	•					
6-POINT DEEP FRACTIONAL	3/8"	KTI33212					•		
	7/16"	KTI33214					•		
	1/2"	KTI33216				•	•		
	9/16"	KTI33218				•	•		
	5/8"	KTI33220				•	•		
	11/16"	KTI33222				•	•		
	3/4"	KTI33224				•	•		
	13/16"	KTI33226				•	•		
	7/8"	KTI33228				•	•		
	15/16"	KTI33230				•	•		
	1"	KTI33232				•	•		
	1-1/16"	KTI33234				•	•		
	1-1/8"	KTI33236				•	•		
	1-3/16"	KTI33238				•	•		
	1-1/4"	KTI33240				•	•		
	1-5/16"	KTI33242				•	•		
	1-3/8"	KTI33244				•	•		
	1-7/16"	KTI33246				•	•		
1-1/2"	KTI33248				•	•			
6-POINT FLEX	1/2"	KTI33516							•
	9/16"	KTI33518							•
	5/8"	KTI33520							•
	11/16"	KTI33522							•
	3/4"	KTI33524							•
	13/16"	KTI33526							•
	7/8"	KTI33528							•
FLIP	3/4" x 13/16"	KTI33050							
	19mm x 21mm	KTI38050							



1/2 Inch Drive Metric Impact Sockets		KTI38100	KTI38101	KTI38200	KTI38201	KTI38202	KTI38500	
6-POINT SHORT METRIC	10mm	KTI38110	•	•				
	11mm	KTI38111	•	•				
	12mm	KTI38112	•	•				
	13mm	KTI38113	•	•				
	14mm	KTI38114	•	•				
	15mm	KTI38115	•	•				
	16mm	KTI38116	•	•				
	17mm	KTI38117	•	•				
	18mm	KTI38118	•	•				
	19mm	KTI38119	•	•				
	20mm	KTI38120	•	•				
	21mm	KTI38121	•	•				
	22mm	KTI38122		•				
	23mm	KTI38123		•				
	24mm	KTI38124		•				
	25mm	KTI38125		•				
	26mm	KTI38126		•				
	27mm	KTI38127		•				
	28mm	KTI38128		•				
	29mm	KTI38129		•				
	30mm	KTI38130		•				
	32mm	KTI38132		•				
	33mm	KTI38133		•				
	34mm	KTI38134		•				
	35mm	KTI38135		•				
	36mm	KTI38136		•				
	6-POINT DEEP METRIC	10mm	KTI38210		•	•		
		11mm	KTI38211		•	•		
		12mm	KTI38212		•	•		
		13mm	KTI38213		•	•		
		14mm	KTI38214		•	•		
		15mm	KTI38215		•	•		
		16mm	KTI38216		•	•		
		17mm	KTI38217		•	•		
		18mm	KTI38218		•	•		
		19mm	KTI38219		•	•		
20mm		KTI38220		•	•			
21mm		KTI38221		•	•			
22mm		KTI38222		•	•			
23mm		KTI38223			•	•		
24mm		KTI38224			•	•		
25mm		KTI38225			•	•		
26mm		KTI38226			•	•		
27mm		KTI38227			•	•		
28mm		KTI38228			•	•		
29mm		KTI38229			•	•		
30mm		KTI38230			•	•		
32mm		KTI38232			•	•		
33mm		KTI38233			•	•		
34mm		KTI38234			•	•		
35mm	KTI38235			•	•			
36mm	KTI38236			•	•			
6-POINT FLEX	13mm	KTI38513					•	
	14mm	KTI38514					•	
	15mm	KTI38515					•	
	17mm	KTI38517					•	
	18mm	KTI38518					•	
19mm	KTI38519					•		

3/4" Drive | IMPACT



3/4 Inch Drive Fractional and Metric Impact Sockets		KT134100	KT134101	KT134200	KT134201	KT139100
6-POINT SHORT FRACTIONAL	1"	KT134132	•			
	1-1/16"	KT134134	•			
	1-1/8"	KT134136	•			
	1-1/4"	KT134140	•			
	1-5/16"	KT134142	•			
	1-3/8"	KT134144	•			
	1-7/16"	KT134146	•			
	1-1/2"	KT134148	•			
	1-9/16"	KT134150		•		
	1-5/8"	KT134152		•		
	1-11/16"	KT134154		•		
	1-3/4"	KT134156		•		
	1-13/16"	KT134158		•		
	1-15/16"	KT134160		•		
	1-7/8"	KT134162		•		
	2"	KT134164		•		
	2-1/16"	KT134166		•		
	2-1/8"	KT134168		•		
	2-1/4"	KT134172		•		
	2-3/8"	KT134176		•		
6-POINT DEEP FRACTIONAL	1"	KT134232		•		
	1-1/16"	KT134234		•		
	1-1/8"	KT134236		•		
	1-1/4"	KT134240		•		
	1-5/16"	KT134242		•		
	1-3/8"	KT134244		•		
	1-7/16"	KT134246		•		
	1-1/2"	KT134248		•		
	1-9/16"	KT134250			•	
	1-5/8"	KT134252			•	
	1-11/16"	KT134254			•	
	1-3/4"	KT134256			•	
	1-13/16"	KT134258			•	
	1-15/16"	KT134260			•	
1-7/8"	KT134262			•		
2"	KT134264			•		
6-POINT SHORT METRIC	17mm	KT139117				•
	19mm	KT139119				•
	20mm	KT139120				•
	22mm	KT139122				•
	24mm	KT139124				•
	27mm	KT139127				•
	30mm	KT139130				•
	31mm	KT139131				•
	32mm	KT139132				•
	34mm	KT139134				•
	35mm	KT139135				•
	36mm	KT139136				•
	38mm	KT139138				•
	40mm	KT139140				•
46mm	KT139146				•	
BUDD WHEEL	13/16" Square	KT134026				
	1-1/2" - 13/16"	KT134027				
	33mm Deep	KT139233				

1" Drive | IMPACT

1 Inch Drive Fractional and Metric Impact Sockets		KT135005	KT135100	KT135113
FRACTIONAL BUDD WHEEL	13/16"	KT135026		
	1-1/2" - 13/16"	KT135027		
	1-1/2" - 13/16"	KT135028	•	
6-POINT SHORT FRACTIONAL	3/4"	KT135124		•
	13/16"	KT135126		•
	7/8"	KT135128		•
	15/16"	KT135130		•
	1"	KT135132		•
	1-1/16"	KT135134		•
	1-1/8"	KT135136		•
	1-3/16"	KT135138		
	1-1/4"	KT135140		•
	1-5/16"	KT135142		•
	1-7/16"	KT135146		•
	1-1/2"	KT135148		•
	1-5/8"	KT135152		•
	1-11/16"	KT135154		•
	1-13/16"	KT135158		•
	1-7/8"	KT135160		•
	2"	KT135164		•
	2-1/16"	KT135166		•
2-1/4"	KT135172		•	
2-7/16"	KT135178		•	
2-5/8"	KT135184		•	
3"	KT135196		•	
6-POINT DEEP FRACTIONAL	1-1/16"	KT135234		
	1-1/8"	KT135236		
	1-1/4"	KT135240		
METRIC BUDD WHEEL	1-5/16"	KT135242		
	33mm	KT135233	•	
	35mm	KT135235	•	
	38mm	KT135238	•	
41mm	KT135241	•		



Sockets and Drive Tools



1/4", 3/8", 1/2 Inch Drive Torx Sockets			KT121500	KT122800	KT122801	KT122870
1/4" DRIVE TAMPER-PROOF	T10	KT121510	•			
	T15	KT121515	•			
	T20	KT121520	•			
	T25	KT121525	•			
	T27	KT121527	•			
3/8" DRIVE TAMPER-PROOF	T40	KT121540	•			
	T45	KT121545	•			
	T50	KT121550	•			
	T55	KT121555	•			
1/4" DRIVE INTERNAL TORX	T10	KT121810		•	•	
	T15	KT121815		•	•	
	T20	KT121820		•	•	
	T25	KT121825		•	•	
	T27	KT121827		•	•	
3/8" DRIVE INTERNAL TORX	T40	KT122840			•	
	T45	KT122845			•	
	T47	KT122847			•	
	T50	KT122850			•	
	T55	KT122855			•	
	T60	KT122860			•	
1/4" DRIVE EXTERNAL TORX	E4	KT122874				•
	E5	KT122875				•
	E6	KT122876				•
	E7	KT122877				•
3/8" DRIVE EXTERNAL TORX	E8	KT122878				•
	E10	KT122880				•
	E12	KT122882				•
	E14	KT122884				•
	E16	KT122886				•
BIT HOLDERS	1/4" Drive (T10 - T40)	KT118008	•			
	3/8" Drive (T45 - T55)	KT118012	•			

1/4", 3/8", 1/2 Inch Drive Torx Sockets (U.S. MADE)			KT122600	KT122601	KT122671
1/4" DRIVE INTERNAL TORX	T10	KT121610	•	•	
	T15	KT121615	•	•	
	T20	KT121620	•	•	
	T25	KT121625	•	•	
	T27	KT121627	•	•	
	T30	KT121630	•	•	
3/8" DRIVE INTERNAL TORX	T40	KT122640	•	•	
	T45	KT122645	•	•	
	T47	KT122647		•	
	T50	KT122650	•	•	
	T55	KT122655		•	
1/2" DRIVE INTERNAL TORX	T60	KT122660		•	
	T70	KT122670			
1/4" DRIVE EXTERNAL TORX	E5	KT122675			•
	E6	KT122676			•
	E7	KT122677			•
	E8	KT122678			•
3/8" DRIVE EXTERNAL TORX	E10	KT122680			•
	E12	KT122682			•
	E14	KT122684			•
	E16	KT122686			•
	E18	KT122688			•
1/2" DRIVE EXTERNAL TORX	E20	KT122689			•



Made in U.S.A.

3/8 Inch Drive Hex Bit Sockets			KT122902	KT122970	KT127902	KT127970
FRACTIONAL BITS	1/8"	KT122904		•		
	5/32"	KT122905		•		
	3/16"	KT122906		•		
	7/32"	KT122907		•		
	1/4"	KT122908	•	•		
	5/16"	KT122910	•	•		
	3/8"	KT122912	•	•		
METRIC HEX BITS	3mm	KT127903				•
	4mm	KT127904				•
	5mm	KT127905				•
	5.5mm	KT127955				
	6mm	KT127906				•
	7mm	KT127907			•	•
	8mm	KT127908			•	•
	10mm	KT127910			•	•



KT122970
7-Piece Fractional
Hex Bit Set 3/8" Drive

Includes 7 pieces 1/8" through 3/8" on socket rail.
 Chrome vanadium steel, heat-treated.

Set includes (also available individually):

- KT122904** - 1/8" Hex Bit
- KT122905** - 5/32" Hex Bit
- KT122906** - 3/16" Hex Bit
- KT122907** - 7/32" Hex Bit

- KT122908** - 1/4" Hex Bit
- KT122910** - 5/16" Hex Bit
- KT122912** - 3/8" Hex Bit



KT127970
7-Piece Metric
Hex Bit Set 3/8" Drive

Includes 7 pieces 3mm through 10mm on socket rail.
 Chromevanadium steel, heat-treated.

Set includes (also available individually):

- KT127903** - 3mm Hex Bit
- KT127904** - 4mm Hex Bit
- KT127905** - 5mm Hex Bit
- KT127906** - 6mm Hex Bit

- KT127907** - 7mm Hex Bit
- KT127908** - 8mm Hex Bit
- KT127910** - 10mm Hex Bit



KT122902
3-Piece Fractional
Brake Caliper Set
3/8" Drive

Use on disc brake calipers to remove and install brake pads. Disk brake caliper set features hardened and tempered chrome vanadium steel sockets with professional sand finish. Bits are heat-treated and precision machined. Set includes 1/4", 5/16" and 3/8" hex bits. Available for individual purchase.

Set includes (also available individually):

- KT122908** - 1/4" Hex Bit
- KT122910** - 5/16" Hex Bit
- KT122912** - 3/8" Hex Bit



KT127902
3-Piece Metric
Brake Caliper Set
3/8" Drive

Use on disc brake calipers to remove and install brake pads. Disk brake caliper set features hardened and tempered chrome vanadium steel sockets with professional sand finish. Bits are heat-treated and precision machined. Set includes 7mm, 8mm and 10mm hex bits. Available for individual purchase.

Set includes (also available individually):

- KT127907** - 7mm Hex Bit
- KT127908** - 8mm Hex Bit
- KT127910** - 10mm Hex Bit



External Torq Sockets
 Heat-treated.

1/4" Drive

- KT122874** - E4 External Torq
- KT122875** - E5 External Torq
- KT122876** - E6 External Torq
- KT122877** - E7 External Torq
- KT122878** - E8 External Torq

3/8" Drive

- KT122880** - E10 External Torq
- KT122882** - E12 External Torq
- KT122884** - E14 External Torq
- KT122886** - E16 External Torq
- KT122888** - E18 External Torq



Internal Torq Sockets
 Chrome vanadium steel, heat-treated.

1/4" Drive

- KT121810** - T10 Internal Torq
- KT121815** - T15 Internal Torq
- KT121820** - T20 Internal Torq
- KT121825** - T25 Internal Torq
- KT121827** - T27 Internal Torq
- KT121830** - T30 Internal Torq

3/8" Drive

- KT122840** - T40 Internal Torq
- KT122845** - T45 Internal Torq
- KT122847** - T47 Internal Torq
- KT122850** - T50 Internal Torq
- KT122855** - T55 Internal Torq
- KT122860** - T60 Internal Torq



Sockets and Drive Tools

External Torx Sockets U.S.-made

Heat-treated. U.S.-made



1/4" Drive

- KTI22675** - E5 External Torx
- KTI22676** - E6 External Torx
- KTI22677** - E7 External Torx
- KTI22678** - E8 External Torx

3/8" Drive

- KTI22680** - E10 External Torx
- KTI22682** - E12 External Torx
- KTI22684** - E14 External Torx
- KTI22686** - E16 External Torx

1/2" Drive

- KTI22688** - E18 External Torx
- KTI22689** - E20 External Torx



Tamper-Proof Torx Sockets U.S.-made

Chrome vanadium steel, heat-treated. U.S.-made



1/4" Drive

- KTI21510** - T10 Internal Torx
- KTI21515** - T15 Internal Torx
- KTI21520** - T20 Internal Torx
- KTI21525** - T25 Internal Torx
- KTI21527** - T27 Internal Torx
- KTI21530** - T30 Internal Torx

3/8" Drive

- KTI21540** - T40 Internal Torx
- KTI21545** - T45 Internal Torx
- KTI21550** - T50 Internal Torx
- KTI21555** - T55 Internal Torx



Internal Torx Sockets U.S.-made

Alloy steel, heat-treated. U.S.-made



1/4" Drive

- KTI21610** - T10 Internal Torx
- KTI21615** - T15 Internal Torx
- KTI21620** - T20 Internal Torx
- KTI21625** - T25 Internal Torx
- KTI21627** - T27 Internal Torx
- KTI21630** - T30 Internal Torx

3/8" Drive

- KTI22640** - T40 Internal Torx
- KTI22645** - T45 Internal Torx
- KTI22647** - T47 Internal Torx
- KTI22650** - T50 Internal Torx
- KTI22655** - T55 Internal Torx

1/2" Drive

- KTI22660** - T60 Internal Torx
- KTI22670** - T70 Internal Torx



KTI22802 3-Piece Brake Caliper Torq Bit Set 3/8" Drive

Three-piece set includes T-40, T-45 and T-50 Torq bits. Use on disc brake calipers to remove and install brake pads. Fits most GM and Ford brake caliper torx bolts. Bits are heat-treated and precision machined. All are 3/8" drive.



Set includes (also available individually):

- KTI22840** - T40 Internal Torq
- KTI22845** - T45 Internal Torq
- KTI22850** - T50 Internal Torq



Universal Joints

Chrome vanadium steel, heat-treated.

- KTI21050** - 1/4" Drive Universal Joint
- KTI22500** - 3/8" Drive Universal Joint
- KTI23500** - 1/2" Drive Universal Joint
- KTI24500** - 3/4" Drive Universal Joint



Reducers and Adapters

Chrome vanadium steel, heat-treated.

- KTI21055** - 1/4" Female to 3/8" Male
- KTI22050** - 1/2" Female to 3/8" Male
- KTI22055** - 3/8" Female to 1/2" Male
- KTI22060** - 3/8" Female to 1/4" Male
- KTI22075** - 1/2" Female to 3/4" Male
- KTI24050** - 3/4" Female to 1/2" Male



KTI23308 Bit Holder 1/2 drive

- 1/4" Hex Male to 1/2" Male Square Drive





Premium Quality Ratchets

Push button release. High-polish chrome finish, chrome vanadium steel, premium gears.

1/4" Drive
KTI21091 - 5¼" Premium

1/2" Drive
KTI23091 - 9-7/8" Premium

3/8" Drive
KTI22091 - 8" Premium

3/4" Drive
KTI24090 - 19-7/8" Premium

1/4" Drive
3/8" Drive
1/2" Drive
3/4" Drive
LIFETIME WARRANTY*
R
KTI24090RK



Professional Series Ratchets

High-polished chrome. Push-button design socket release. Thumb lever directional switch. Fine-tooth thin design. Knurled handles.

1/4" Drive
KTI21092* - 4½" Pro Series
KTI21095 - 7" Long Handle

1/2" Drive
KTI23092* - 9-7/8" Pro Series
KTI23095 - 15" Long Handle

3/8" Drive
KTI22092* - 7-7/8" Pro Series
KTI22093 - 10½" Flex Head
KTI22095 - 11-3/8" Long Handle

3/4" Drive
KTI24092 - 19-5/8" Pro Series
3/4" Drive ratchet features lightweight alloy handle for ease of use.

1/4" Drive
3/8" Drive
1/2" Drive
3/4" Drive
LIFETIME WARRANTY*
R
KTI21092RK
KTI22092RK
KTI23092RK



Standard Extensions

Chrome vanadium steel, heat-treated.

1/4" Drive
KTI21002 - 2" Extension
KTI21004 - 4" Extension
KTI21006 - 6" Extension
KTI21010 - 10" Extension
KTI21014 - 14" Extension

3/8" Drive
KTI22002 - 2" Extension
KTI22003 - 3" Extension
KTI22005 - 5" Extension
KTI22006 - 6" Extension
KTI22008 - 8" Extension
KTI22010 - 10" Extension
KTI22012 - 12" Extension
KTI22018 - 18" Extension
KTI22024 - 24" Extension

1/2" Drive
KTI23003 - 3" Extension
KTI23005 - 5" Extension
KTI23010 - 10" Extension
KTI23015 - 15" Extension
KTI23020 - 20" Extension

3/4" Drive
KTI24004 - 4" Extension
KTI24008 - 8" Extension
KTI24016 - 16" Extension

1/4" Drive
3/8" Drive
1/2" Drive
3/4" Drive
LIFETIME WARRANTY*



KTI21040 Wobble Extension Set 1/4" Drive

Chrome vanadium steel, heat-treated. Available individually.

Set includes (also available individually):
KTI21043 - 4" Wobble Extension
KTI21046 - 6" Wobble Extension
KTI21048 - 9" Wobble Extension

1/4" Drive
i
LIFETIME WARRANTY*



KTI22041 Wobble Extension Set 3/8" Drive

Chrome vanadium steel, heat-treated. Available individually.

Set includes (also available individually):
KTI22043 - 3" Wobble Extension
KTI22046 - 6" Wobble Extension
KTI22048 - 8" Wobble Extension

3/8" Drive
i
LIFETIME WARRANTY*

Sockets and Drive Tools



Flex Handle

Provides extra leverage for breaking loose rusted or high torque fasteners. Smooth action flex joint for hard-to-reach fasteners. Knurled handle for secure grip. Pivoting head allows the handle to avoid obstructions when being turned in a cramped space. Chrome vanadium steel for long life and maximum corrosion resistance.

1/4" Drive

KT121080 - 6" Flex Handle

3/8" Drive

KT122080 - 8" Flex Handle

1/2" Drive

KT123080 - 17" Flex Handle

KT123081 - 24" Flex Handle

KT123082 - 18" to 25" Extending Flex Handle

KT123083 - 10" Flex Handle

3/4" Drive

KT124080 - 20" Flex Handle



Sliding T-handle

Made with high-polish, chrome vanadium steel. Allows you accessibility to hard-to-reach areas.

1/2" Drive

KT123070 - Sliding T-handle

3/4" Drive

KT124070 - Sliding T-handle



KT122001

Speed T-handle Set

Constructed with a lightweight aluminum sleeve for fast turning. A locking end holds sockets securely in place. The pivoting end is great to reach odd angles and offers greater versatility. A 3/8" drive end allows the speed T-handle to be used with a ratchet like an extension. The speed T-handle set includes 1/4" and 3/8" speed T-handles and a posi-lock adapter that allows the use of any 1/4" hex bit. Set is packaged in a blow-molded case.

Set includes (also available individually):

1/4" Drive

KT121070 - 1/4"

3/8" Drive

KT122070 - 3/8"



KT121060

Spinner Handle

1/4" Drive

Screwdriver style drive tool for quick spin down/off. Oversize polypropylene handle and chrome vanadium shaft. 1/4" drive.



KT122071

3/8" Drive Speed Handle

Speed handle is designed to reach tough access points that a standard ratchet cannot reach to tighten or remove a variety of fasteners. Lightweight design makes any job quick and easy. 3/8" drive.





KTI22300
8-Piece Fractional
Flare Nut Crowfoot
Wrench Set 3/8" Drive

Used for air conditioning, fuel and hydraulic line fittings. Heat treated, carded with socket rail. Available individually.

Set includes (also available individually):

- | | |
|-------------------------|--------------------------|
| KTI22312 - 3/8" | KTI22320 - 5/8" |
| KTI22314 - 7/16" | KTI22322 - 11/16" |
| KTI22316 - 1/2" | KTI22324 - 3/4" |
| KTI22318 - 9/16" | KTI22328 - 7/8" |



KTI27300
10-Piece Metric
Flare Nut Crowfoot
Wrench Set 3/8" Drive

Used for air conditioning, fuel and hydraulic line fittings. Heat treated, carded with socket rail. Available individually.

Set includes (also available individually):

- | | |
|------------------------|------------------------|
| KTI27310 - 10mm | KTI27315 - 15mm |
| KTI27311 - 11mm | KTI27316 - 16mm |
| KTI27312 - 12mm | KTI27317 - 17mm |
| KTI27313 - 13mm | KTI27318 - 18mm |
| KTI27314 - 14mm | KTI27319 - 19mm |



KTI22600
9-Piece Internal
Torx Socket Set

Heat-treated alloy steel. Vinyl holder. U.S.-made

Set includes (also available individually):

- | | |
|-------------------------------------|-------------------------------------|
| 1/4" Drive | 3/8" Drive |
| KTI21610 - T10 Internal Torx | KTI22640 - T40 Internal Torx |
| KTI21615 - T15 Internal Torx | KTI22645 - T45 Internal Torx |
| KTI21620 - T20 Internal Torx | KTI22650 - T50 Internal Torx |
| KTI21625 - T25 Internal Torx | |
| KTI21627 - T27 Internal Torx | |
| KTI21630 - T30 Internal Torx | |



KTI22601
12-Piece Internal
Torx Socket Set

Heat-treated alloy steel. Vinyl holder. U.S.-made

Set includes (also available individually):

- | | |
|-------------------------------------|-------------------------------------|
| 1/4" Drive | 3/8" Drive |
| KTI21610 - T10 Internal Torx | KTI22640 - T40 Internal Torx |
| KTI21615 - T15 Internal Torx | KTI22645 - T45 Internal Torx |
| KTI21620 - T20 Internal Torx | KTI22647 - T47 Internal Torx |
| KTI21625 - T25 Internal Torx | KTI22650 - T50 Internal Torx |
| KTI21627 - T27 Internal Torx | KTI22655 - T55 Internal Torx |
| KTI21630 - T30 Internal Torx | |
| | 1/2" Drive |
| | KTI22660 - T60 Internal Torx |



KTI22800
9-Piece Internal
Torq Socket Set

Chrome moly steel, heat-treated. Carded on socket rail.

Set includes (also available individually):

- | | |
|-------------------------------------|-------------------------------------|
| 1/4" Drive | 3/8" Drive |
| KTI21810 - T10 Internal Torq | KTI22840 - T40 Internal Torq |
| KTI21815 - T15 Internal Torq | KTI22845 - T45 Internal Torq |
| KTI21820 - T20 Internal Torq | KTI22850 - T50 Internal Torq |
| KTI21825 - T25 Internal Torq | |
| KTI21827 - T27 Internal Torq | |
| KTI21830 - T30 Internal Torq | |



KTI22801
12-Piece Internal
Torq Socket Set

Chrome vanadium steel, heat-treated. Carded on socket rail.

Set includes (also available individually):

- | | |
|-------------------------------------|-------------------------------------|
| 1/4" Drive | 3/8" Drive |
| KTI21810 - T10 Internal Torq | KTI22840 - T40 Internal Torq |
| KTI21815 - T15 Internal Torq | KTI22845 - T45 Internal Torq |
| KTI21820 - T20 Internal Torq | KTI22847 - T47 Internal Torq |
| KTI21825 - T25 Internal Torq | KTI22850 - T50 Internal Torq |
| KTI21827 - T27 Internal Torq | KTI22855 - T55 Internal Torq |
| KTI21830 - T30 Internal Torq | KTI22860 - T60 Internal Torq |



Sockets and Drive Tools



KTI21500
10-Piece
Tamper-Proof Torx Socket Set
 Heat-treated alloy steel. Vinyl holder. U.S.-made

Set includes (also available individually):

1/4" Drive

- KTI21510** - T10 Tamper-proof
- KTI21515** - T15 Tamper-proof
- KTI21520** - T20 Tamper-proof
- KTI21525** - T25 Tamper-proof
- KTI21527** - T27 Tamper-proof
- KTI21530** - T30 Tamper-proof
- KTI18008** - Bit Holder (T10-T30)

3/8" Drive

- KTI21540** - T40 Tamper-proof
- KTI21545** - T45 Tamper-proof
- KTI21550** - T50 Tamper-proof
- KTI21555** - T55 Tamper-proof
- KTI18012** - Bit Holder (T40-T60)



KTI22870
10-Piece
External Torq
Socket Set
 Chrome vanadium steel, heat-treated. On socket rail.

Set includes (also available individually):

1/4" Drive

- KTI22874** - E4 External Torq
- KTI22875** - E5 External Torq
- KTI22876** - E6 External Torq
- KTI22877** - E7 External Torq
- KTI22878** - E8 External Torq

3/8" Drive

- KTI22880** - E10 External Torq
- KTI22882** - E12 External Torq
- KTI22884** - E14 External Torq
- KTI22886** - E16 External Torq
- KTI22888** - E18 External Torq



KTI22671
10-Piece External Torx Socket Set
 Chrome vanadium steel, heat-treated. On socket rail.

Set includes (also available individually):

1/4" Drive

- KTI22675** - E5 External Torx
- KTI22676** - E6 External Torx
- KTI22677** - E7 External Torx
- KTI22678** - E8 External Torx

3/8" Drive

- KTI22680** - E10 External Torx
- KTI22682** - E12 External Torx
- KTI22684** - E14 External Torx
- KTI22686** - E16 External Torx

1/2" Drive

- KTI22688** - E18 External Torx
- KTI22689** - E20 External Torx



KTI21000
21-Piece Fractional
6-point Socket Set
1/4" Drive

Includes 9 short sockets from 3/16" to 1/2", 7 deep sockets from 1/4" to 1/2", push button ratchet, universal joint, 2" and 4" extensions and spinner. All sockets are 6-point chrome vanadium. Blow-molded case.

Set includes (also available individually):

- | | | |
|--------------------------|-------------------------------|-----------------------------------|
| KTI21106 - 3/16" | KTI21114 - 7/16" | KTI21214 - 7/16" deep |
| KTI21107 - 7/32" | KTI21116 - 1/2" | KTI21216 - 1/2" deep |
| KTI21108 - 1/4" | KTI21208 - 1/4" deep | KTI21091 - Ratchet |
| KTI21109 - 9/32" | KTI21209 - 9/32" deep | KTI21002 - 2" Extension |
| KTI21110 - 5/16" | KTI21210 - 5/16" deep | KTI21004 - 4" Extension |
| KTI21111 - 11/32" | KTI21211 - 11/32" deep | KTI21050 - Universal Joint |
| KTI21112 - 3/8" | KTI21212 - 3/8" deep | KTI21060 - Spinner Handle |



KTI26000
21-Piece Metric
6-point Socket Set
1/4" Drive

Includes 9 short sockets from 4mm to 11mm, 7 deep sockets from 5.5mm to 11mm, push button ratchet, universal joint, 2" and 4" extensions and spinner. All sockets are 6-point chrome vanadium.

Set includes (also available individually):

- | | | |
|-------------------------|------------------------------|-----------------------------------|
| KTI26104 - 4mm | KTI26110 - 10mm | KTI26210 - 10mm deep |
| KTI26105 - 5mm | KTI26111 - 11mm | KTI26211 - 11mm deep |
| KTI26155 - 5.5mm | KTI26255 - 5.5mm deep | KTI21091 - Ratchet |
| KTI26106 - 6mm | KTI26206 - 6mm deep | KTI21002 - 2" Extension |
| KTI26107 - 7mm | KTI26207 - 7mm deep | KTI21004 - 4" Extension |
| KTI26108 - 8mm | KTI26208 - 8mm deep | KTI21050 - Universal Joint |
| KTI26109 - 9mm | KTI26209 - 9mm deep | KTI21060 - Spinner Handle |



KTI21100
8-Piece Fractional
6-Point Socket Set
1/4" Drive - Short



6-point sockets, chrome vanadium steel, heat-treated, on socket rail.

Set includes (also available individually):

- | | |
|-------------------------|-------------------------|
| KTI21106 - 3/16" | KTI21110 - 5/16" |
| KTI21107 - 7/32" | KTI21112 - 3/8" |
| KTI21108 - 1/4" | KTI21114 - 7/16" |
| KTI21109 - 9/32" | KTI21116 - 1/2" |



KTI21200
8-Piece Fractional
6-Point Socket Set
1/4" Drive - Deep



6-point sockets, chrome vanadium steel, heat-treated, on socket rail.

Set includes (also available individually):

- | | |
|------------------------------|-------------------------------|
| KTI21207 - 7/32" deep | KTI21211 - 11/32" deep |
| KTI21208 - 1/4" deep | KTI21212 - 3/8" deep |
| KTI21209 - 9/32" deep | KTI21214 - 7/16" deep |
| KTI21210 - 5/16" deep | KTI21216 - 1/2" deep |



KTI26100
8-Piece Metric
6-Point Socket Set
1/4" Drive - Short



6-point sockets, chrome vanadium steel, heat-treated, on socket rail.

Set includes (also available individually):

- | | |
|-----------------------|------------------------|
| KTI26106 - 6mm | KTI26110 - 10mm |
| KTI26107 - 7mm | KTI26111 - 11mm |
| KTI26108 - 8mm | KTI26112 - 12mm |
| KTI26109 - 9mm | KTI26113 - 13mm |



KTI26200
8-Piece Metric
6-Point Socket Set
1/4" Drive - Deep



6-point sockets, chrome vanadium steel, heat-treated, on socket rail.

Set includes (also available individually):

- | | |
|----------------------------|-----------------------------|
| KTI26206 - 6mm deep | KTI26210 - 10mm deep |
| KTI26207 - 7mm deep | KTI26211 - 11mm deep |
| KTI26208 - 8mm deep | KTI26212 - 12mm deep |
| KTI26209 - 9mm deep | KTI26213 - 13mm deep |



KTI21044
44-piece Fractional and
Metric 6-point Socket Set 1/4" Drive

Includes a 1/4" drive pro ratchet, 2" extension, 6" extension, standard length fractional sockets 3/16" to 9/16", deep fractional sockets 1/4" to 9/16", standard length metric sockets from 4mm to 15mm, deep metric sockets 6mm to 15mm. Chrome vanadium, heat-treated, packaged in blow molded case.

Set includes (also available individually):

- | | | | | |
|--------------------------|-------------------------------|-------------------------|-----------------------------|--------------------------------|
| KTI21106 - 3/16" | KTI21118 - 9/16" | KTI26104 - 4mm | KTI26112 - 12mm | KTI26211 - 11mm deep |
| KTI21107 - 7/32" | KTI21208 - 1/4" deep | KTI26105 - 5mm | KTI26113 - 13mm | KTI26212 - 12mm deep |
| KTI21108 - 1/4" | KTI21209 - 9/32" deep | KTI26155 - 5.5mm | KTI26114 - 14mm | KTI26213 - 13mm deep |
| KTI21109 - 9/32" | KTI21210 - 5/16" deep | KTI26106 - 6mm | KTI26115 - 15mm | KTI26214 - 14mm deep |
| KTI21110 - 5/16" | KTI21211 - 11/32" deep | KTI26107 - 7mm | KTI26206 - 6mm deep | KTI26215 - 15mm deep |
| KTI21111 - 11/32" | KTI21212 - 3/8" deep | KTI26108 - 8mm | KTI26207 - 7mm deep | KTI21092 - Ratchet |
| KTI21112 - 3/8" | KTI21214 - 7/16" deep | KTI26109 - 9mm | KTI26208 - 8mm deep | KTI21002 - 2" Extension |
| KTI21114 - 7/16" | KTI21216 - 1/2" deep | KTI26110 - 10mm | KTI26209 - 9mm deep | KTI21006 - 6" Extension |
| KTI21116 - 1/2" | KTI21218 - 9/16" deep | KTI26111 - 11mm | KTI26210 - 10mm deep | |



Sockets and Drive Tools

KTI20045

45-Piece Fractional and Metric Spline Socket Set 3/8" Drive

Spline socket set features standard and deep fractional (5/16" to 7/8") and metric (7mm to 19mm) sockets. The set also includes a 3/8" drive ratchet and 3- and 6-inch wobble extensions. The universal spline socket design works on various fasteners such as spline, 6-point, 12-point, female torx and square. It will even work on 50% rounded fasteners! It's like having six sockets in one! Features high-polish chrome-vanadium finish, which provides for long life and maximum corrosion resistance. Packaged in a blow-molded case.

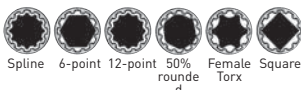

Set includes (also available individually):

- | | | | | |
|--------------------------|-------------------------------|-----------------------------|-----------------------------|--------------------------------|
| KTI20210 - 5/16" | KTI20228 - 7/8" | KTI20428 - 7/8" deep | KTI20318 - 18mm | KTI20714 - 14mm deep |
| KTI20212 - 3/8" | KTI20412 - 3/8" deep | KTI20310 - 10mm | KTI20319 - 19mm | KTI20715 - 15mm deep |
| KTI20214 - 7/16" | KTI20414 - 7/16" deep | KTI20311 - 11mm | KTI20707 - 7mm deep | KTI20716 - 16mm deep |
| KTI20216 - 1/2" | KTI20416 - 1/2" deep | KTI20312 - 12mm | KTI20708 - 8mm deep | KTI20717 - 17mm deep |
| KTI20218 - 9/16" | KTI20418 - 9/16" deep | KTI20313 - 13mm | KTI20709 - 9mm deep | KTI20718 - 18mm deep |
| KTI20220 - 5/8" | KTI20420 - 5/8" deep | KTI20314 - 14mm | KTI20710 - 10mm deep | KTI20719 - 19mm deep |
| KTI20222 - 11/16" | KTI20422 - 11/16" deep | KTI20315 - 15mm | KTI20711 - 11mm deep | KTI22092 - Ratchet |
| KTI20224 - 3/4" | KTI20424 - 3/4" deep | KTI20316 - 16mm | KTI20712 - 12mm deep | KTI22003 - 3" Extension |
| KTI20226 - 13/16" | KTI20426 - 13/16" deep | KTI20317 - 17mm | KTI20713 - 13mm deep | KTI22006 - 6" Extension |



KTI22000

20-Piece Fractional 6-Point Socket Set 3/8" Drive

Includes 9 short sockets from 3/8" to 7/8", 8 deep sockets from 3/8" to 13/16", push button ratchet plus 2" and 3" extensions. All sockets are 6-point chrome vanadium. Blow-molded case.



Set includes (also available individually):

- | | | |
|--------------------------|------------------------------|--------------------------------|
| KTI22112 - 3/8" | KTI22126 - 13/16" | KTI22222 - 11/16" deep |
| KTI22114 - 7/16" | KTI22128 - 7/8" | KTI22224 - 3/4" deep |
| KTI22116 - 1/2" | KTI22212 - 3/8" deep | KTI22226 - 13/16" deep |
| KTI22118 - 9/16" | KTI22214 - 7/16" deep | KTI22091 - Ratchet |
| KTI22120 - 5/8" | KTI22216 - 1/2" deep | KTI22002 - 2" Extension |
| KTI22122 - 11/16" | KTI22218 - 9/16" deep | KTI22003 - 3" Extension |
| KTI22124 - 3/4" | KTI22220 - 5/8" deep | |



KTI27000

26-Piece Metric 6-Point Socket Set 3/8" Drive

Includes 14 short sockets from 8mm to 21mm, 9 deep sockets from 10mm to 19mm, push button ratchet, spark plug socket and extension. All sockets are 6-point chrome vanadium. Blow-molded case.



Set includes (also available individually):

- | | | |
|------------------------|-----------------------------|-----------------------------------|
| KTI27108 - 8mm | KTI27117 - 17mm | KTI27214 - 14mm deep |
| KTI27109 - 9mm | KTI27118 - 18mm | KTI27216 - 16mm deep |
| KTI27110 - 10mm | KTI27119 - 19mm | KTI27217 - 17mm deep |
| KTI27111 - 11mm | KTI27120 - 20mm | KTI27218 - 18mm deep |
| KTI27112 - 12mm | KTI27121 - 21mm | KTI27219 - 19mm deep |
| KTI27113 - 13mm | KTI27210 - 10mm deep | KTI22219 - 5/8" Spark Plug |
| KTI27114 - 14mm | KTI27211 - 11mm deep | KTI22091 - Ratchet |
| KTI27115 - 15mm | KTI27212 - 12mm deep | KTI22003 - 3" Extension |
| KTI27116 - 16mm | KTI27213 - 13mm deep | |



KTI22100

10-Piece Fractional 6-Point Socket Set 3/8" Drive - Short

Includes 6-point sockets from 5/16" to 7/8", chrome vanadium steel, heat-treated, on socket rail.



Set includes (also available individually):

- | | |
|-------------------------|--------------------------|
| KTI22110 - 5/16" | KTI22120 - 5/8" |
| KTI22112 - 3/8" | KTI22122 - 11/16" |
| KTI22114 - 7/16" | KTI22124 - 3/4" |
| KTI22116 - 1/2" | KTI22126 - 13/16" |
| KTI22118 - 9/16" | KTI22128 - 7/8" |



KTI22201

9-Piece Fractional 6-Point Socket Set 3/8" Drive - Deep

Includes 6-point sockets from 3/8" to 7/8", chrome vanadium steel, heat-treated, on socket rail.



Set includes (also available individually):

- | | |
|------------------------------|-------------------------------|
| KTI22212 - 3/8" deep | KTI22222 - 11/16" deep |
| KTI22214 - 7/16" deep | KTI22224 - 3/4" deep |
| KTI22216 - 1/2" deep | KTI22226 - 13/16" deep |
| KTI22218 - 9/16" deep | KTI22228 - 7/8" deep |
| KTI22220 - 5/8" deep | |



KTI22501
13-Piece Fractional
12-Point Socket Set
3/8" Drive - Short



Includes 12-point sockets from 1/4" to 1", chrome vanadium steel, heat-treated, on socket rail.

Set includes (also available individually):

- | | | |
|-------------------------|--------------------------|--------------------------|
| KTI22508 - 1/4" | KTI22518 - 9/16" | KTI22528 - 7/8" |
| KTI22510 - 5/16" | KTI22520 - 5/8" | KTI22530 - 15/16" |
| KTI22512 - 3/8" | KTI22522 - 11/16" | KTI22532 - 1" |
| KTI22514 - 7/16" | KTI22524 - 3/4" | |
| KTI22516 - 1/2" | KTI22526 - 13/16" | |



KTI22401
13-Piece Fractional
12-Point Socket Set
3/8" Drive - Deep



Includes 12-point sockets from 1/4" to 1", chrome vanadium steel, heat-treated, on socket rail.

Set includes (also available individually):

- | | | |
|------------------------------|-------------------------------|-----------------------------|
| KTI22408 - 1/4" deep | KTI22418 - 9/16" deep | KTI22428 - 7/8" deep |
| KTI22410 - 5/16" deep | KTI22420 - 5/8" deep | KTI22430 - 15/16" |
| KTI22412 - 3/8" deep | KTI22422 - 11/16" deep | KTI22432 - 1" deep |
| KTI22414 - 7/16" deep | KTI22424 - 3/4" deep | |
| KTI22416 - 1/2" deep | KTI22426 - 13/16" deep | |



KTI27101
13-Piece Metric
6-Point Socket Set
3/8" Drive - Short



Includes 6-point sockets from 7mm to 19mm, chrome vanadium steel, heat-treated, on socket rail.

Set includes (also available individually):

- | | | |
|------------------------|------------------------|------------------------|
| KTI27107 - 7mm | KTI27112 - 12mm | KTI27117 - 17mm |
| KTI27108 - 8mm | KTI27113 - 13mm | KTI27118 - 18mm |
| KTI27109 - 9mm | KTI27114 - 14mm | KTI27119 - 19mm |
| KTI27110 - 10mm | KTI27115 - 15mm | |
| KTI27111 - 11mm | KTI27116 - 16mm | |



KTI27201
9-Piece Metric
6-Point Socket Set
3/8" Drive - Deep



Includes 6-point sockets from 10mm to 18mm, chrome vanadium steel, heat-treated, on socket rail.

Set includes (also available individually):

- | | |
|------------------------|------------------------|
| KTI27210 - 10mm | KTI27215 - 15mm |
| KTI27211 - 11mm | KTI27216 - 16mm |
| KTI27212 - 12mm | KTI27217 - 17mm |
| KTI27213 - 13mm | KTI27218 - 18mm |
| KTI27214 - 14mm | |



KTI27501
15-Piece Metric
12-Point Socket Set
3/8" Drive - Short



Includes 12-point sockets from 7mm to 21mm, chrome vanadium steel, heat-treated, on socket rail.

Set includes (also available individually):

- | | | |
|------------------------|------------------------|------------------------|
| KTI27507 - 7mm | KTI27512 - 12mm | KTI27517 - 17mm |
| KTI27508 - 8mm | KTI27513 - 13mm | KTI27518 - 18mm |
| KTI27509 - 9mm | KTI27514 - 14mm | KTI27519 - 19mm |
| KTI27510 - 10mm | KTI27515 - 15mm | KTI27520 - 20mm |
| KTI27511 - 11mm | KTI27516 - 16mm | KTI27521 - 21mm |



KTI27401
15-Piece Metric
12-Point Socket Set
3/8" Drive - Deep



Includes 12-point sockets from 7mm to 21mm, chrome vanadium steel, heat-treated, on socket rail.

Set includes (also available individually):

- | | | |
|-----------------------------|-----------------------------|-----------------------------|
| KTI27407 - 7mm deep | KTI27412 - 12mm deep | KTI27417 - 17mm deep |
| KTI27408 - 8mm deep | KTI27413 - 13mm deep | KTI27418 - 18mm deep |
| KTI27409 - 9mm deep | KTI27414 - 14mm deep | KTI27419 - 19mm deep |
| KTI27410 - 10mm deep | KTI27415 - 15mm deep | KTI27420 - 20mm deep |
| KTI27411 - 11mm deep | KTI27416 - 16mm deep | KTI27421 - 21mm deep |



KTI22700
8-Piece Universal 12-Point Socket Set 3/8" Drive

Eight-piece set includes 5/16" to 3/4" universal joints. Use with an extension to turn bolts or nuts in difficult-to-access areas. Chrome vanadium steel, heat-treated. All universal joints are 3/8" drive, 12-point sockets.

Set includes (also available individually):

- | | | | |
|-------------------------|-------------------------|-------------------------|--------------------------|
| KTI22710 - 5/16" | KTI22714 - 7/16" | KTI22718 - 9/16" | KTI22722 - 11/16" |
| KTI22712 - 3/8" | KTI22716 - 1/2" | KTI22720 - 5/8" | KTI22724 - 3/4" |



Sockets and Drive Tools

KTI22047

47-Piece Fractional and Metric 6-point Socket Set 3/8" Drive

This 47-piece 3/8" drive fractional and metric set includes all the sockets you need in one box. Set contains: short fractional sockets from 1/4"-7/8"; deep fractional sockets from 3/8"-7/8"; short metric sockets from 6mm - 19mm; deep metric sockets from 10mm - 19mm; 3/8 drive pro ratchet; 3" extension; 6" extension. All sockets are 6-point. Manufactured with heat-treated chrome vanadium steel. Packaged in custom blow-molded carrying case. Lifetime warranty.

Set includes (also available individually):

KTI22108 - 1/4"
KTI22110 - 5/16"
KTI22112 - 3/8"
KTI22114 - 7/16"
KTI22116 - 1/2"
KTI22118 - 9/16"
KTI22120 - 5/8"
KTI22122 - 11/16"
KTI22124 - 3/4"
KTI22126 - 13/16"

KTI22128 - 7/8"
KTI22212 - 3/8" deep
KTI22214 - 7/16" deep
KTI22216 - 1/2" deep
KTI22218 - 9/16" deep
KTI22220 - 5/8" deep
KTI22222 - 11/16" deep
KTI22224 - 3/4" deep
KTI22226 - 13/16" deep
KTI22228 - 7/8" deep

KTI27106 - 6mm
KTI27107 - 7mm
KTI27108 - 8mm
KTI27109 - 9mm
KTI27110 - 10mm
KTI27111 - 11mm
KTI27112 - 12mm
KTI27113 - 13mm
KTI27114 - 14mm
KTI27115 - 15mm

KTI27116 - 16mm
KTI27117 - 17mm
KTI27118 - 18mm
KTI27119 - 19mm
KTI27210 - 10mm deep
KTI27211 - 11mm deep
KTI27212 - 12mm deep
KTI27213 - 13mm deep
KTI27214 - 14mm deep
KTI27215 - 15mm deep

KTI27216 - 16mm deep
KTI27217 - 17mm deep
KTI27218 - 18mm deep
KTI27219 - 19mm deep
KTI22092 - Ratchet
KTI22003 - 3" Extension
KTI22006 - 6" Extension



KTI22547

47-Piece Fractional and Metric 12-point Socket Set 3/8" Drive

This 47-piece 3/8" drive fractional and metric set includes all the sockets you need in one box. Set contains: short fractional sockets from 1/4" - 7/8"; deep fractional sockets from 3/8"-7/8"; short metric sockets from 6mm - 19mm; deep metric sockets from 10mm - 19mm; 3/8 drive pro ratchet; 3" extension; 6" extension. All sockets are 12-point. Manufactured with heat-treated chrome vanadium steel. Packaged in custom blow-molded carrying case. Lifetime warranty.

Set includes (also available individually):

KTI22508 - 1/4"
KTI22510 - 5/16"
KTI22512 - 3/8"
KTI22514 - 7/16"
KTI22516 - 1/2"
KTI22518 - 9/16"
KTI22520 - 5/8"
KTI22522 - 11/16"
KTI22524 - 3/4"
KTI22526 - 13/16"

KTI22528 - 7/8"
KTI22412 - 3/8" deep
KTI22414 - 7/16" deep
KTI22416 - 1/2" deep
KTI22418 - 9/16" deep
KTI22420 - 5/8" deep
KTI22422 - 11/16" deep
KTI22424 - 3/4" deep
KTI22426 - 13/16" deep
KTI22428 - 7/8" deep

KTI27506 - 6mm
KTI27507 - 7mm
KTI27508 - 8mm
KTI27509 - 9mm
KTI27510 - 10mm
KTI27511 - 11mm
KTI27512 - 12mm
KTI27513 - 13mm
KTI27514 - 14mm
KTI27515 - 15mm

KTI27516 - 16mm
KTI27517 - 17mm
KTI27518 - 18mm
KTI27519 - 19mm
KTI27410 - 10mm deep
KTI27411 - 11mm deep
KTI27412 - 12mm deep
KTI27413 - 13mm deep
KTI27414 - 14mm deep
KTI27415 - 15mm deep

KTI27416 - 16mm deep
KTI27417 - 17mm deep
KTI27418 - 18mm deep
KTI27419 - 19mm deep
KTI22092 - Ratchet
KTI22003 - 3" Extension
KTI22006 - 6" Extension



KTI22023

23 Piece 3/8" Drive Chrome Socket Set

- 3/8" drive pro-series ratchet, flex handle and speed handle
- Short fractional sockets from 3/8" to 7/8"; deep fractional sockets from 1/2" to 13/16"
- Includes universal joint and 1/2" and 9/16" universal sockets
- 6" and 12" extensions
- All sockets are 12-point

Features high polish chrome vanadium finish, which provides for long life and maximum corrosion resistance. Packaged in a blow-molded plastic case.





KTI23000
16-Piece Fractional
6-Point Socket Set
1/2" Drive - Short

Includes 13 sockets from 7/16" through 1 1/4", ratchet, breaker bar and extension. All sockets are 6-point chrome vanadium. Blow-molded case.

- Set includes (also available individually):
- | | | |
|--------------------------|---------------------------|-----------------------------------|
| KTI23114 - 7/16" | KTI23126 - 13/16" | KTI23140 - 1-1/4" |
| KTI23116 - 1/2" | KTI23128 - 7/8" | KTI23091 - Ratchet |
| KTI23118 - 9/16" | KTI23130 - 15/16" | KTI23005 - 5" Extension |
| KTI23120 - 5/8" | KTI23132 - 1" | KTI23080 - 17" Breaker bar |
| KTI23122 - 11/16" | KTI23134 - 1-1/16" | |
| KTI23124 - 3/4" | KTI23136 - 1-1/8" | |

1/2" Drive **6 POINT** **i** **LIFETIME WARRANTY***



KTI28000
17-Piece Metric
6-Point Socket Set
1/2" Drive - Short

Includes 14 sockets from 15mm to 28mm, push button ratchet, breaker bar and 5" extension. All sockets are 6-point chrome vanadium. Blow-molded case.

- Set includes (also available individually):
- | | | |
|------------------------|------------------------|-----------------------------------|
| KTI28115 - 15mm | KTI28121 - 21mm | KTI28127 - 27mm |
| KTI28116 - 16mm | KTI28122 - 22mm | KTI28128 - 28mm |
| KTI28117 - 17mm | KTI28123 - 23mm | KTI23091 - Ratchet |
| KTI28118 - 18mm | KTI28124 - 24mm | KTI23005 - 5" Extension |
| KTI28119 - 19mm | KTI28125 - 25mm | KTI23080 - 17" Breaker bar |
| KTI28120 - 20mm | KTI28126 - 26mm | |

1/2" Drive **6 POINT** **i** **LIFETIME WARRANTY***



KTI23110
13-Piece Fractional
6-Point Socket Set
1/2" Drive - Short

Includes 6-point sockets from 7/16" to 1 1/4", chrome vanadium steel, heat-treated.

- Set includes (also available individually):
- | | | |
|--------------------------|--------------------------|---------------------------|
| KTI23114 - 7/16" | KTI23124 - 3/4" | KTI23134 - 1-1/16" |
| KTI23116 - 1/2" | KTI23126 - 13/16" | KTI23136 - 1-1/8" |
| KTI23118 - 9/16" | KTI23128 - 7/8" | KTI23140 - 1-1/4" |
| KTI23120 - 5/8" | KTI23130 - 15/16" | |
| KTI23122 - 11/16" | KTI23132 - 1" | |

1/2" Drive **6 POINT** **i** **LIFETIME WARRANTY***



KTI23200
8-Piece Fractional
6-Point Socket Set
1/2" Drive - Deep

Includes 6-point sockets from 1/2" to 15/16", chrome vanadium steel, heat-treated.

- Set includes (also available individually):
- | | |
|-------------------------------|-------------------------------|
| KTI23216 - 1/2" deep | KTI23224 - 3/4" deep |
| KTI23218 - 9/16" deep | KTI23226 - 13/16" deep |
| KTI23220 - 5/8" deep | KTI23228 - 7/8" deep |
| KTI23222 - 11/16" deep | KTI23230 - 15/16" deep |

1/2" Drive **6 POINT** **i** **LIFETIME WARRANTY***



KTI28100
14-Piece Metric
6-Point Socket Set
1/2" Drive - Short

Includes 6-point sockets from 15mm to 28mm, chrome vanadium steel, heat-treated, on socket rail.

- Set includes (also available individually):
- | | | |
|------------------------|------------------------|------------------------|
| KTI28115 - 15mm | KTI28120 - 20mm | KTI28125 - 25mm |
| KTI28116 - 16mm | KTI28121 - 21mm | KTI28126 - 26mm |
| KTI28117 - 17mm | KTI28122 - 22mm | KTI28127 - 27mm |
| KTI28118 - 18mm | KTI28123 - 23mm | KTI28128 - 28mm |
| KTI28119 - 19mm | KTI28124 - 24mm | |

1/2" Drive **6 POINT** **i** **LIFETIME WARRANTY***



KTI28200
10-Piece Metric
6-Point Socket Set
1/2" Drive - Deep

Includes 6-point sockets from 15mm to 24mm, chrome vanadium steel, heat-treated, on socket rail.

- Set includes (also available individually):
- | | |
|-----------------------------|-----------------------------|
| KTI28215 - 15mm deep | KTI28220 - 20mm deep |
| KTI28216 - 16mm deep | KTI28221 - 21mm deep |
| KTI28217 - 17mm deep | KTI28222 - 22mm deep |
| KTI28218 - 18mm deep | KTI28223 - 23mm deep |
| KTI28219 - 19mm deep | KTI28224 - 24mm deep |

1/2" Drive **6 POINT** **i** **LIFETIME WARRANTY***

Sockets and Drive Tools

KT123800

4-Piece Fractional Stud Remover Set 1/2" Drive

Chrome vanadium, heat-treated.
Blow-molded case. Available individually.

Set includes (also available individually):

- KT123808** - 1/4"
- KT123810** - 5/16"
- KT123812** - 3/8"
- KT123814** - 7/16"



1/2" Drive **i** **LIFETIME WARRANTY***

KT123900

4-Piece Metric Stud Remover Set 1/2" Drive

Chrome vanadium, heat-treated.
Blow-molded case. Available individually.

Set includes (also available individually):

- KT123906** - 6mm
- KT123908** - 8mm
- KT123910** - 10mm
- KT123912** - 12mm



1/2" Drive **i** **LIFETIME WARRANTY***

KT123248

Heating Element Socket 1/2" Drive

1/2" drive 1 1/2" deep socket. Drop forged, heat-treated chrome vanadium steel construction. Corrosion-resistant chrome-plated finish. 6-point beveled-end socket with a notched drive end that locks onto ratchet or extension. Fits heating element in many electric water heaters.



1/2" Drive **6 POINT** **i** **LIFETIME WARRANTY***



KT128206

6-Piece Spindle Nut 6-Point Socket Set 1/2" Drive

6-piece set includes 29mm, 30mm, 32mm, 34mm, 35mm and 36mm. Heat-treated, chrome plated, chrome vanadium, 6-point deep.

Set includes (also available individually):

- KT128229** - 29mm deep
- KT128230** - 30mm deep
- KT128232** - 32mm deep
- KT128234** - 34mm deep
- KT128235** - 35mm deep
- KT128236** - 36mm deep

1/2" Drive **6 POINT** **i** **LIFETIME WARRANTY***



KT124121

20-Piece Fractional 6-Point Socket Set 3/4" Drive

This high-polish set includes 16 sockets from 3/4" to 2", ratchet, T-handle and 4" and 8" extensions. All sockets are 6-point chrome vanadium. Packaged in blow-molded case.

Set includes (also available individually):

- KT124124** - 3/4"
- KT124128** - 7/8"
- KT124130** - 15/16"
- KT124132** - 1"
- KT124134** - 1-1/16"
- KT124136** - 1-1/8"
- KT124138** - 1-13/16"
- KT124140** - 1-1/4"
- KT124142** - 1-5/16"
- KT124144** - 1-3/8"
- KT124146** - 1-7/16"
- KT124148** - 1-1/2"
- KT124152** - 1-5/8"
- KT124156** - 1-3/4"
- KT124160** - 1-7/8"
- KT124164** - 2"
- KT124090** - Ratchet
- KT124004** - 4" Extension
- KT124008** - 8" Extension
- KT124070** - T-handle

3/4" Drive **6 POINT** **i** **LIFETIME WARRANTY***



KT124105

5-Piece Fractional 6-Point Socket Set 3/4" Drive

Socket assortment is a perfect addition to the KT124121 3/4" drive socket set. Includes 5 sockets from 2-1/16" to 2-3/8". Chrome vanadium.

Set includes (also available individually):

- KT124166** - 2-1/16"
- KT124168** - 2-1/8"
- KT124170** - 2-3/16"
- KT124172** - 2-1/4"
- KT124176** - 2-3/8"

3/4" Drive **6 POINT** **i** **LIFETIME WARRANTY***

KTI32100
9-Piece Fractional Impact Socket Set
3/8" Drive - Short



Includes 6-point sockets from 3/8" to 7/8". Chrome moly steel, thin wall impact, heat-treated. Blow-molded case.

- Set includes (also available individually):
- | | |
|-------------------------|--------------------------|
| KTI32112 - 3/8" | KTI32122 - 11/16" |
| KTI32114 - 7/16" | KTI32124 - 3/4" |
| KTI32116 - 1/2" | KTI32126 - 13/16" |
| KTI32118 - 9/16" | KTI32128 - 7/8" |
| KTI32120 - 5/8" | |



KTI32200
9-Piece Fractional Impact Socket Set
3/8" Drive - Deep



Includes 6-point sockets from 3/8" to 7/8". Chrome moly steel, thin wall impact, heat-treated. Blow-molded case.

- Set includes (also available individually):
- | | |
|------------------------------|-------------------------------|
| KTI32212 - 3/8" deep | KTI32222 - 11/16" deep |
| KTI32214 - 7/16" deep | KTI32224 - 3/4" deep |
| KTI32216 - 1/2" deep | KTI32226 - 13/16" deep |
| KTI32218 - 9/16" deep | KTI32228 - 7/8" deep |
| KTI32220 - 5/8" deep | |



KTI37100
10-Piece Metric Impact Socket Set
3/8" Drive - Short



Includes 6-point sockets from 10mm to 19mm. Chrome moly steel, thin wall impact, heat-treated. Blow-molded case.

- Set includes (also available individually):
- | | |
|------------------------|------------------------|
| KTI37110 - 10mm | KTI37115 - 15mm |
| KTI37111 - 11mm | KTI37116 - 16mm |
| KTI37112 - 12mm | KTI37117 - 17mm |
| KTI37113 - 13mm | KTI37118 - 18mm |
| KTI37114 - 14mm | KTI37119 - 19mm |



KTI37200
10-Piece Metric Impact Socket Set
3/8" Drive - Deep



Includes 6-point sockets from 10mm to 19mm. Chrome moly steel, thin wall impact, heat-treated. Blow-molded case.

- Set includes (also available individually):
- | | |
|-----------------------------|-----------------------------|
| KTI37210 - 10mm deep | KTI37215 - 15mm deep |
| KTI37211 - 11mm deep | KTI37216 - 16mm deep |
| KTI37212 - 12mm deep | KTI37217 - 17mm deep |
| KTI37213 - 13mm deep | KTI37218 - 18mm deep |
| KTI37214 - 14mm deep | KTI37219 - 19mm deep |



KTI32500
6-Piece Fractional Impact Flex Socket Set
3/8" Drive - Short



Includes 6-point sockets from 7/16" to 3/4". Chrome moly steel, close quarter, thin wall, heat-treated. Blow-molded case.

- Set includes (also available individually):
- | | |
|-------------------------|--------------------------|
| KTI32514 - 7/16" | KTI32520 - 5/8" |
| KTI32516 - 1/2" | KTI32522 - 11/16" |
| KTI32518 - 9/16" | KTI32524 - 3/4" |



KTI32400
6-Piece Fractional Impact Flex Socket Set
3/8" Drive - Deep



Includes 6-point sockets from 7/16" to 3/4". Chrome moly steel, close quarter, thin wall, heat-treated.

- Set includes (also available individually):
- | | |
|------------------------------|-------------------------------|
| KTI32414 - 7/16" deep | KTI32420 - 5/8" deep |
| KTI32416 - 1/2" deep | KTI32422 - 11/16" deep |
| KTI32418 - 9/16" deep | KTI32424 - 3/4" deep |



Sockets and Drive Tools



KTI37500 6-Piece Metric Impact Flex Socket Set 3/8" Drive - Short

Includes 6-point sockets from 10mm to 15mm. Chrome moly steel, close quarter, thin wall, heat-treated. Blow-molded case.

Set includes (also available individually):

KTI37510 - 10mm	KTI37513 - 13mm
KTI37511 - 11mm	KTI37514 - 14mm
KTI37512 - 12mm	KTI37515 - 15mm



KTI37400 10-Piece Metric Impact Flex Socket Set 3/8" Drive - Deep

Includes 6-point sockets from 10mm to 19mm. Chrome moly steel, thin wall, heat-treated. Blow-molded case.

Set includes (also available individually):

KTI37410 - 10mm deep	KTI37415 - 15mm deep
KTI37411 - 11mm deep	KTI37416 - 16mm deep
KTI37412 - 12mm deep	KTI37417 - 17mm deep
KTI37413 - 13mm deep	KTI37418 - 18mm deep
KTI37414 - 14mm deep	KTI37419 - 19mm deep



KTI37042 42-piece Fractional and Metric Impact Socket Set 3/8" Drive

42-piece fractional and metric impact socket set is manufactured from heat-treated chrome-moly steel for wear in professional, rugged environments. Set includes 8 short fractional sockets sized from 5/16" to 3/4", 8 deep fractional sockets sized from 5/16" to 3/4", 12 short metric sockets sized from 8mm to 19mm, 12 deep metric sockets sized from 8mm to 19mm, universal joint and 3" extension. All sockets are 6-point, 3/8" drive. Laser engraved for quick identification. Packaged in a convenient blow-molded case.

Set includes (also available individually):

KTI32110 - 5/16"	KTI32212 - 3/8" deep	KTI37110 - 10mm
KTI32112 - 3/8"	KTI32214 - 7/16" deep	KTI37111 - 11mm
KTI32114 - 7/16"	KTI32216 - 1/2" deep	KTI37112 - 12mm
KTI32116 - 1/2"	KTI32218 - 9/16" deep	KTI37113 - 13mm
KTI32118 - 9/16"	KTI32220 - 5/8" deep	KTI37114 - 14mm
KTI32120 - 5/8"	KTI32222 - 11/16" deep	KTI37115 - 15mm
KTI32122 - 11/16"	KTI32224 - 3/4" deep	KTI37116 - 16mm
KTI32124 - 3/4"	KTI37108 - 8mm	KTI37117 - 17mm
KTI32210 - 5/16" deep	KTI37109 - 9mm	KTI37118 - 18mm



KTI37119 - 19mm	KTI37216 - 16mm deep
KTI37208 - 8mm deep	KTI37217 - 17mm deep
KTI37209 - 9mm deep	KTI37218 - 18mm deep
KTI37210 - 10mm deep	KTI37219 - 19mm deep
KTI37211 - 11mm deep	KTI32003 - 3" Extension
KTI37212 - 12mm deep	KTI32013 - Universal Joint
KTI37213 - 13mm deep	
KTI37214 - 14mm deep	
KTI37215 - 15mm deep	



KTI33100
12-Piece Fractional
Impact Socket Set
1/2" Drive - Short

Includes 6-point sockets from 1/2" to 1 1/4", chrome moly steel, thin wall impact, heat-treated. Blow-molded case.

Set includes (also available individually):

- | | | |
|--------------------------|--------------------------|---------------------------|
| KTI33116 - 1/2" | KTI33124 - 3/4" | KTI33132 - 1" |
| KTI33118 - 9/16" | KTI33126 - 13/16" | KTI33134 - 1-1/16" |
| KTI33120 - 5/8" | KTI33128 - 7/8" | KTI33136 - 1-1/8" |
| KTI33122 - 11/16" | KTI33130 - 15/16" | KTI33140 - 1-1/4" |



KTI33200
12-Piece Fractional
Impact Socket Set
1/2" Drive - Deep

Includes 6-point sockets from 1/2" to 1 1/4", chrome moly steel, thin wall impact, heat-treated. Blow-molded case.

Set includes (also available individually):

- | | | |
|--------------------------|--------------------------|---------------------------|
| KTI33216 - 1/2" | KTI33224 - 3/4" | KTI33232 - 1" |
| KTI33218 - 9/16" | KTI33226 - 13/16" | KTI33234 - 1-1/16" |
| KTI33220 - 5/8" | KTI33228 - 7/8" | KTI33236 - 1-1/8" |
| KTI33222 - 11/16" | KTI33230 - 15/16" | KTI33240 - 1-1/4" |



KTI33104
4-Piece Fractional
Impact Socket Set
1/2" Drive - Short

Includes 6-point sockets, including 1 5/16", 1 3/8", 1 7/16", 1 1/2".

Set includes (also available individually):

- KTI33142** - 1-5/16"
- KTI33144** - 1-3/8"
- KTI33146** - 1-7/16"
- KTI33148** - 1-1/2"



KTI33204
4-Piece Fractional
Impact Socket Set
1/2" Drive - Deep

Includes 6-point sockets, including 1 5/16", 1 3/8", 1 7/16", 1 1/2".

Set includes (also available individually):

- KTI33242** - 1-5/16"
- KTI33244** - 1-3/8"
- KTI33246** - 1-7/16"
- KTI33248** - 1-1/2"



KTI38100
12-Piece Metric
Impact Socket Set
1/2" Drive - Short

Includes 6-point sockets from 10mm to 21mm, chrome moly steel, thin wall impact, heat-treated. Blow-molded case.

Set includes (also available individually):

- | | | |
|------------------------|------------------------|------------------------|
| KTI38110 - 10mm | KTI38114 - 14mm | KTI38118 - 18mm |
| KTI38111 - 11mm | KTI38115 - 15mm | KTI38119 - 19mm |
| KTI38112 - 12mm | KTI38116 - 16mm | KTI38120 - 20mm |
| KTI38113 - 13mm | KTI38117 - 17mm | KTI38121 - 21mm |



KTI38200
12-Piece Metric
Impact Socket Set
1/2" Drive - Deep

Includes 6-point sockets from 10mm to 21mm, chrome moly steel, thin wall impact, heat-treated. Blow-molded case.

Set includes (also available individually):

- | | | |
|------------------------|------------------------|------------------------|
| KTI38210 - 10mm | KTI38214 - 14mm | KTI38218 - 18mm |
| KTI38211 - 11mm | KTI38215 - 15mm | KTI38219 - 19mm |
| KTI38212 - 12mm | KTI38216 - 16mm | KTI38220 - 20mm |
| KTI38213 - 13mm | KTI38217 - 17mm | KTI38221 - 21mm |



Sockets and Drive Tools

KTI33101 19-Piece Fractional Impact Socket Set 1/2" Drive - Short

Includes 6-point sockets from 3/8" to 1 1/2", chrome moly steel, thin wall impact, heat-treated.



Set includes (also available individually):

KTI33112 - 3/8"	KTI33126 - 13/16"	KTI33140 - 1-1/4"
KTI33114 - 7/16"	KTI33128 - 7/8"	KTI33142 - 1-5/16"
KTI33116 - 1/2"	KTI33130 - 15/16"	KTI33144 - 1-3/8"
KTI33118 - 9/16"	KTI33132 - 1"	KTI33146 - 1-7/16"
KTI33120 - 5/8"	KTI33134 - 1-1/16"	KTI33148 - 1-1/2"
KTI33122 - 11/16"	KTI33136 - 1-1/8"	
KTI33124 - 3/4"	KTI33138 - 1-3/16"	

1/2" Drive **6 POINT** **i** **LIFETIME WARRANTY***

KTI38101 26-Piece Metric Impact Socket Set 1/2" Drive - Short

Includes 6-point sockets from 10mm to 36mm, chrome moly steel, thin wall impact, heat-treated.



Set includes (also available individually):

KTI38110 - 10mm	KTI38119 - 19mm	KTI38128 - 28mm
KTI38111 - 11mm	KTI38120 - 20mm	KTI38129 - 29mm
KTI38112 - 12mm	KTI38121 - 21mm	KTI38130 - 30mm
KTI38113 - 13mm	KTI38122 - 22mm	KTI38132 - 32mm
KTI38114 - 14mm	KTI38123 - 23mm	KTI38133 - 33mm
KTI38115 - 15mm	KTI38124 - 24mm	KTI38134 - 34mm
KTI38116 - 16mm	KTI38125 - 25mm	KTI38135 - 35mm
KTI38117 - 17mm	KTI38126 - 26mm	KTI38136 - 36mm
KTI38118 - 18mm	KTI38127 - 27mm	

1/2" Drive **6 POINT** **i** **LIFETIME WARRANTY***

KTI33500 7-Piece Fractional Impact Flex Socket Set 1/2" Drive

Includes 6-point sockets from 1/2" to 7/8", chrome moly steel, thin wall, heat-treated. Blow-molded case.



Set includes (also available individually):

KTI33516 - 1/2"	KTI33524 - 3/4"
KTI33518 - 9/16"	KTI33526 - 13/16"
KTI33520 - 5/8"	KTI33528 - 7/8"
KTI33522 - 11/16"	

1/2" Drive **6 POINT** **i** **LIFETIME WARRANTY***

KTI33202 19-Piece Fractional Impact Socket Set 1/2" Drive - Deep

Includes 6-point sockets from 3/8" to 1 1/2", chrome moly steel, thin wall impact, heat-treated.



Set includes (also available individually):

KTI33212 - 3/8"	KTI33226 - 13/16"	KTI33240 - 1-1/4"
KTI33214 - 7/16"	KTI33228 - 7/8"	KTI33242 - 1-5/16"
KTI33216 - 1/2"	KTI33230 - 15/16"	KTI33244 - 1-3/8"
KTI33218 - 9/16"	KTI33232 - 1"	KTI33246 - 1-7/16"
KTI33220 - 5/8"	KTI33234 - 1-1/16"	KTI33248 - 1-1/2"
KTI33222 - 11/16"	KTI33236 - 1-1/8"	
KTI33224 - 3/4"	KTI33238 - 1-3/16"	

1/2" Drive **6 POINT** **i** **LIFETIME WARRANTY***

KTI38202 26-Piece Metric Impact Socket Set 1/2" Drive - Deep

Includes 6-point sockets from 10mm to 36mm, chrome moly steel, thin wall impact, heat-treated.



Set includes (also available individually):

KTI38210 - 10mm	KTI38219 - 19mm	KTI38228 - 28mm
KTI38211 - 11mm	KTI38220 - 20mm	KTI38229 - 29mm
KTI38212 - 12mm	KTI38221 - 21mm	KTI38230 - 30mm
KTI38213 - 13mm	KTI38222 - 22mm	KTI38232 - 32mm
KTI38214 - 14mm	KTI38223 - 23mm	KTI38233 - 33mm
KTI38215 - 15mm	KTI38224 - 24mm	KTI38234 - 34mm
KTI38216 - 16mm	KTI38225 - 25mm	KTI38235 - 35mm
KTI38217 - 17mm	KTI38226 - 26mm	KTI38236 - 36mm
KTI38218 - 18mm	KTI38227 - 27mm	

1/2" Drive **6 POINT** **i** **LIFETIME WARRANTY***

KTI38500 6-Piece Metric Impact Flex Socket Set 1/2" Drive

Includes 6 point sockets from 13mm to 19mm, chrome moly steel, thin wall, heat-treated. Blow-molded case.



Set includes (also available individually):

KTI38513 - 13mm	KTI38517 - 17mm
KTI38514 - 14mm	KTI38518 - 18mm
KTI38515 - 15mm	KTI38519 - 19mm

1/2" Drive **6 POINT** **i** **LIFETIME WARRANTY***

KTI38201
9-Piece Metric
Impact Socket Set
1/2" Drive - Deep



Includes 6 point sockets from 22mm to 30mm, chrome moly steel, thin wall, heat-treated.

Set includes (also available individually):
KTI38222 - 22mm **KTI38227** - 27mm
KTI38223 - 23mm **KTI38228** - 28mm
KTI38224 - 24mm **KTI38229** - 29mm
KTI38225 - 25mm **KTI38230** - 30mm
KTI38226 - 26mm



KTI34100
8-Piece Fractional
Impact Socket Set
3/4" Drive - Short



Includes 6 point sockets from 1" to 1½", chrome moly steel, heat-treated. Blow-molded case.

Set includes (also available individually):
KTI34132 - 1" **KTI34142** - 1-5/16"
KTI34134 - 1-1/16" **KTI34144** - 1-3/8"
KTI34136 - 1-1/8" **KTI34146** - 1-7/16"
KTI34140 - 1-1/4" **KTI34148** - 1-1/2"



KTI34101
12-Piece Fractional
Impact Socket Set
3/4" Drive - Short



Includes 6-point sockets from 1⁹/₁₆" to 2³/₈", chrome moly steel, heat-treated.

Set includes (also available individually):
KTI34150 - 1-9/16" **KTI34158** - 1-13/16" **KTI34166** - 2-1/16"
KTI34152 - 1-5/8" **KTI34160** - 1-15/16" **KTI34168** - 2-1/8"
KTI34154 - 1-11/16" **KTI34162** - 1-7/8" **KTI34172** - 2-1/4"
KTI34156 - 1-3/4" **KTI34164** - 2" **KTI34176** - 2-3/8"



KTI34200
8-Piece Fractional
Impact Socket Set
3/4" Drive - Deep



Includes 6-point sockets from 1" to 1½", chrome moly steel, heat-treated. Blow-molded case.

Set includes (also available individually):
KTI34232 - 1" **KTI34242** - 1-5/16"
KTI34234 - 1-1/16" **KTI34244** - 1-3/8"
KTI34236 - 1-1/8" **KTI34246** - 1-7/16"
KTI34240 - 1-1/4" **KTI34248** - 1-1/2"



KTI34201
8-Piece Fractional
Impact Socket Set
3/4" Drive - Deep



Includes 6-point sockets from 1⁹/₁₆" to 2", chrome moly steel, heat-treated.

Set includes (also available individually):
KTI34250 - 1-9/16" **KTI34258** - 1-13/16"
KTI34252 - 1-5/8" **KTI34260** - 1-15/16"
KTI34254 - 1-11/16" **KTI34262** - 1-7/8"
KTI34256 - 1-3/4" **KTI34264** - 2"



KTI39100
15-Piece Metric
Impact Socket Set
3/4" Drive - Short



Includes metric sockets sized 17mm to 46mm and replacement o-rings and pins. This set is capable of handling larger applications, such as removal of truck wheels and lug nuts. Manufactured from heat-treated chrome-moly steel. Packaged in a convenient blow-molded case.

Set includes (also available individually):
KTI39117 - 17mm **KTI39130** - 30mm **KTI39138** - 38mm
KTI39119 - 19mm **KTI39131** - 31mm **KTI39140** - 40mm
KTI39120 - 20mm **KTI39132** - 32mm **KTI39146** - 46mm
KTI39122 - 22mm **KTI39134** - 34mm **KTI39001** - O-rings 1.42"/36mm
KTI39124 - 24mm **KTI39135** - 35mm **KTI39003** - Pins 1.375"/35mm
KTI39127 - 27mm **KTI39136** - 36mm



Sockets and Drive Tools

KT135005 5-Piece Budd Wheel Socket Set 1" Drive

Remove both nut and stud with just one socket. Use with 1" square drive impact wrench. Set includes 33mm, 35mm, 38mm, 41mm and 1 1/2" hex Budd wheel sockets. Available individually.



Set includes (also available individually):
KT135233 - 33mm
KT135235 - 35mm
KT135238 - 38mm
KT135241 - 41mm
KT135028 - 1-1/2" - 13/16"



Impact Reducers and Adapters

Heat-treated.



KT132016 - 3/8" female x 1/2" male
KT133012 - 1/2" female x 3/8" male
KT133041 - 1/2" female x 3/8" male (wobble)
KT133024 - 1/2" female x 3/4" male
KT134016 - 3/4" female x 1/2" male
KT134032 - 3/4" female x 1" male
KT135024 - 1" female x 3/4" male



Impact Universal Joints

Chrome moly steel, heat-treated, short overall length.

KT132012 - 3/8" Drive Impact Universal Joint
KT133016 - 1/2" Drive Impact Universal Joint
KT134050 - 3/4" Drive Impact Universal Joint



KT124085 Ratcheting Adapter 3/4" Drive

- Ratcheting adapter 3/4 inch drive
- Heat treated chrome vanadium
- 3/4" female x 3/4" male



KT135100 18-Piece Fractional Impact Socket Set 1" Drive - Short

Includes fractional sockets sized 3/4" to 2" and replacement o-rings and pins. Manufactured from heat-treated chrome-moly steel. Packaged in a convenient blow-molded case.



Set includes (also available individually):

KT135124 - 3/4"	KT135142 - 1-5/16"	KT135007 - 7" Extension
KT135126 - 13/16"	KT135146 - 1-7/16"	KT135013 - 13" Extension
KT135128 - 7/8"	KT135148 - 1-1/2"	KT135001 - O-rings 1.75"/45mm
KT135130 - 15/16"	KT135152 - 1-5/8"	KT135002 - O-rings 2"/51mm
KT135132 - 1"	KT135154 - 1-11/16"	KT135003 - Pins 1.75"/45mm
KT135134 - 1-1/16"	KT135158 - 1-13/16"	KT135004 - Pins 2"/51mm
KT135136 - 1-1/8"	KT135160 - 1-7/8"	
KT135140 - 1-1/4"	KT135164 - 2"	



Impact Budd Wheel Sockets

Chrome moly steel, heat-treated, short overall length.

3/4" Drive

KT134026 - 13/16" Square
KT134027 - 13/16" Square x 1 1/2" Hex
KT139233 - 33mm Deep



1" Drive

KT135026 - 13/16" Square
KT135027 - 13/16" Sq. x 1 1/2" Hex Limited
KT135028 - 13/16" Sq. x 1 1/2" Hex Deep

KT135233 - 33mm Hex
KT135235 - 35mm Hex
KT135238 - 38mm Hex
KT135241 - 41mm Hex



Impact Extensions

Feature ball detent for easy removal. Heat-treated.

3/8" Drive

KTI32003 - 3" Impact Extension

1/2" Drive

KTI33003 - 3" Impact Extension

KTI33006 - 6" Impact Extension

1" Drive

KTI35007 - 7" Impact Extension

KTI35013 - 13" Impact Extension



KTI71700

Impact Driver with 4-Piece Bit Set 3/8" Drive

A 3/8" driver with four (4) 5/16" hex bits (small slotted, large slotted, #2 Phillips and #3 Phillips) for loosening rusted screws, nuts and bolts. Packaged in a metal box.



Bits also available individually:

KTI18801 - Small Slotted Bit

KTI18802 - Large Slotted Bit

KTI18702 - #2 Phillips Bit

KTI18703 - #3 Phillips Bit



KTI71910

9-Piece Locking Lug Nut Remover Kit

Removes locking lug nuts and locking hubcaps on most vehicles. For use with impact wrenches. Packaged in blow-molded case.

Includes:

- Dual-sided Twist Socket Lugnut/Lugbolt Remover
- Small Dual-sided Socket
- SM Dual Socket
- Socket Installing Driver
- Extractor Punch
- GM Spline Hubcap Lock Remover
- GM Hubcap Lock Remover
- Ford / Chrysler Cylinder
- Large Chrysler Cylinder



KTI71920

7-Piece Wheel Bearing Locknut Socket Set 1/2" Drive

Includes 55mm hex, 2-3/8" hex, 2-1/2" hex, 2-1/2" rounded hex, 2-3/4" rounded hex, 2-9/16" rounded hex and 2-3/8" rounded hex locknut sockets. Available individually.



Set includes (also available individually):

KTI71921 - 55mm Hex Locknut Socket

KTI71922 - 2-3/8" Hex Locknut Socket

KTI71923 - 2-1/2" Hex Locknut Socket

KTI71924 - 2-1/2" Rounded Hex Locknut Socket

KTI71925 - 2-3/4" Rounded Hex Locknut Socket

KTI71926 - 2-9/16" Rounded Hex Locknut Socket

KTI71927 - 2-3/8" Rounded Hex Locknut Socket



Specialty Sockets

3/8" Drive

Flex Spark Plug Sockets:

Flex joint 3/8" drive, chrome plated, chrome vanadium steel, heat-treated.

KTI22521 - 5/8"

KTI22527 - 13/16"



Spark Plug Sockets:

6-point with rubber plug holder, hex top for wrench in tight areas.

KTI22221 - 5/8"

KTI22227 - 13/16"



2-in-1 Socket:

For oil sending units or stoplight switch replacement.

KTI22133



Extra-long Spark Plug Socket:

4 1/2" long for deep recessed plugs, rubber insert, exterior hex, knurled top, black oxide finish.

KTI22219 - 4-1/2" long



Oxygen Sensor Socket:

Removes and installs oxygen sensors on most domestic and some import vehicles. 3/8" drive or 1" wrench.

KTI32229





Wrenches



Combination Wrenches

All KTI wrenches feature:

- Drop forged steel construction
- Chrome-plated and heat-treated to achieve maximum wear
- Marked with part number and size for ease of identification
- Lifetime warranty

Raised panel:

- Provides additional strength and durability

Professional Series:

- Features high-polish, smooth-finish

Ratcheting/Reversible Ratcheting:

- Speed of a ratchet with the accessibility of a wrench
- Ratcheting box end needs as little as 5° to move fastener



Choose from:

Raised Panel • High Polish • Ratcheting

Reversible Ratcheting • Short • Jumbo • Crowsfoot

Fractional Wrenches	RAISED PANEL				RAISED PANEL JUMBO		HIGH POLISH	HIGH POLISH SHORT	RATCHETING	RATCHETING REVERSIBLE	CROWSFOOT	
	KT141016	KT141014	KT141013	KT141011	KT141006	KT141004	KT141304	KT141300	KT141200	KT145400	KT145900	KT122300
1/4	•		•							•		
5/16	•		•							•	•	
3/8	•	•	•	•			•	•	•	•	•	•
7/16	•	•	•	•			•	•	•	•	•	•
1/2	•	•	•	•			•	•	•	•	•	•
9/16	•	•	•	•			•	•	•	•	•	•
5/8	•	•	•	•			•	•	•	•	•	•
11/16	•	•	•	•			•	•	•	•	•	•
3/4	•	•	•	•			•	•	•	•	•	•
13/16	•	•	•	•			•	•	•	•	•	•
7/8	•	•	•	•			•	•	•	•	•	•
15/16	•	•	•	•			•	•	•	•	•	•
1	•	•	•	•			•	•	•	•	•	•
1-1/16	•	•					•					
1-1/8	•	•					•					
1-1/4	•	•					•					
1-5/16												
1/3/8					•							
1/7/16												
1-1/2					•							
1-5/8					•							
1-3/4					•							
1-13/16												
1-7/8					•							
2					•							
2-1/8						•						
2-1/4						•						
2-3/8						•						
2-1/2						•						

Metric Wrenches	RAISED PANEL	HIGH POLISH			HIGH POLISH SHORT	RATCHETING	RATCHETING REVERSIBLE	CROWSFOOT
	KT141513	KT141802	KT141801	KT141800	KT141700	KT145500	KT145600	KT127300
7mm	•			•				
8mm	•			•		•	•	
9mm	•			•			•	
10mm	•			•	•	•	•	•
11mm	•			•	•		•	•
12mm	•			•	•	•	•	•
13mm	•			•	•	•	•	•
14mm	•			•	•	•	•	•
15mm	•			•	•	•	•	•
16mm	•			•	•		•	•
17mm	•			•	•		•	•
18mm	•			•	•	•	•	•
19mm	•			•			•	•
20mm			•				•	
21mm			•				•	
22mm			•					
23mm			•					
24mm			•				•	
25mm			•					
26mm			•					
27mm			•					
28mm			•					
29mm		•						
30mm		•						
31mm		•						
32mm		•						
33mm		•						
34mm		•						
35mm		•						
36mm		•						

Wrenches

Combination **Fractional**

Raised Panel Fractional Wrenches 12-point

Made of drop forged steel, wrench is chrome-plated and heat-treated to achieve maximum wear. A raised panel provides additional strength and durability. All wrenches are marked with part number and size for ease of identification and come with a lifetime warranty.



Sold separately:

KTI41108 - 1/4"
KTI41110 - 5/16"
KTI41112 - 3/8"
KTI41114 - 7/16"
KTI41116 - 1/2"
KTI41118 - 9/16"
KTI41120 - 5/8"
KTI41122 - 11/16"

KTI41124 - 3/4"
KTI41126 - 13/16"
KTI41128 - 7/8"
KTI41130 - 15/16"
KTI41132 - 1"
KTI41134 - 1-1/16"
KTI41136 - 1-1/8"
KTI41140 - 1-1/4"

KTI41142 - 1-5/16"
KTI41144 - 1-3/8"
KTI41146 - 1-7/16"
KTI41148 - 1-1/2"
KTI41152 - 1-5/8"
KTI41156 - 1-3/4"
KTI41158 - 1-13/16"
KTI41160 - 1-7/8"

KTI41164 - 2"
KTI41168 - 2-1/8"
KTI41172 - 2-1/4"
KTI41176 - 2-3/8"
KTI41180 - 2-1/2"



Raised Panel Fractional Wrenches 6-point

Raised panel combination wrenches are manufactured from chrome vanadium steel and heat-treated for strength. All wrenches are marked with part number and size for ease of identification and come with a lifetime warranty.



Sold separately:

KTI41412 - 3/8"
KTI41414 - 7/16"
KTI41416 - 1/2"

KTI41418 - 9/16"
KTI41420 - 5/8"
KTI41422 - 11/16"
KTI41424 - 3/4"



High Polish Professional Fractional Wrenches 12-point

Professional series fractional wrench features high-polish, smooth-finish, heat-treated chrome vanadium steel. Tool is longer than standard combination wrench to enable access to hard-to-reach places.



Sold separately:

KTI41308 - 1/4"
KTI41310 - 5/16"
KTI41311 - 11/32"
KTI41312 - 3/8"
KTI41314 - 7/16"
KTI41316 - 1/2"

KTI41318 - 9/16"
KTI41320 - 5/8"
KTI41322 - 11/16"
KTI41324 - 3/4"
KTI41326 - 13/16"
KTI41328 - 7/8"

KTI41330 - 15/16"
KTI41332 - 1"
KTI41334 - 1-1/16"
KTI41336 - 1-1/8"
KTI41338 - 1-3/16"
KTI41340 - 1-1/4"

KTI41342 - 1-5/16"
KTI41344 - 1-3/8"
KTI41346 - 1-7/16"
KTI41348 - 1-1/2"
KTI41350 - 1-9/16"
KTI41352 - 1-5/8"



High Polish Professional Fractional Wrenches 12-point Short

Professional series fractional wrenches features high-polish, smooth-finish, heat-treated chrome vanadium steel. Wrenches sized from 3/8" to 3/4". 12-point hex on all box ends.



Sold separately:

KTI41212 - 3/8"
KTI41214 - 7/16"

KTI41216 - 1/2"
KTI41218 - 9/16"

KTI41220 - 5/8"
KTI41222 - 11/16"
KTI41224 - 3/4"



Ratcheting Fractional

Ratcheting Fractional Wrenches

Ratcheting box end needs as little as 5 degrees to move fastener. Designed to reduce fastener rounding. Wrenches feature a sleek head design for tight access points and all metal construction for durability and strength.



Sold separately:

- KTI45410** - 5/16"
- KTI45412** - 3/8"
- KTI45414** - 7/16"

- KTI45416** - 1/2"
- KTI45418** - 9/16"
- KTI45318** - 9/16" Stubby

- KTI45420** - 5/8"
- KTI45424** - 3/4"



Ratcheting Reversible Fractional Wrenches

Enjoy the speed of a ratchet with the accessibility of a wrench in this version with a reversing mechanism. Ratcheting box end needs as little as 5 degrees to move fastener. Reduce fastener rounding. Wrenches feature a sleek head design for tight access points and all metal construction for durability and strength.



Sold separately:

- KTI45908** - 1/4"
- KTI45910** - 5/16"
- KTI45912** - 3/8"
- KTI45914** - 7/16"
- KTI45916** - 1/2"

- KTI45918** - 9/16"
- KTI45920** - 5/8"
- KTI45922** - 11/16"
- KTI45924** - 3/4"

- KTI45926** - 13/16"
- KTI45928** - 7/8"
- KTI45930** - 15/16"
- KTI45932** - 1"



X-Long Double Box Ratcheting / Flexible / Reversible Spline Fractional Wrenches

This extra-long, flexible and reversible double box ratcheting wrench is forged of chrome-vanadium steel and heat-treated for durability. It features a 72-tooth design with a high-polish finish and is nearly 40% longer. Ratcheting box end needs as little as 5 degrees to move fastener. Sleek head design and slim dimensions further ease of working in confined areas.



Sold separately:

- KTI43112** - 5/16" x 3/8"
- KTI43116** - 7/16" x 1/2"
- KTI43120** - 9/16" x 5/8"
- KTI43124** - 11/16" x 3/4"



Ratcheting Box Wrenches Fractional

Combines the ratcheting action of a socket with the low profile of a box wrench, making those hard to reach jobs quick and easy. Lifetime warranty.

Sold separately:

- KTI45208** - 1/4" x 5/16"
- KTI45212** - 3/8" x 7/16"
- KTI45216** - 1/2" x 9/16"
- KTI45220** - 5/8" x 3/4"



Wrenches

Combination Metric

Raised Panel Metric Wrenches 12-point

Made of drop forged steel, wrench is chrome-plated and heat-treated to achieve maximum wear. A raised panel provides additional strength and durability. All wrenches are marked with part number and size for ease of identification and come with a lifetime warranty.

Sold separately:

KTI41607 - 7mm
KTI41608 - 8mm
KTI41609 - 9mm
KTI41610 - 10mm

KTI41611 - 11mm
KTI41612 - 12mm
KTI41613 - 13mm
KTI41614 - 14mm

KTI41615 - 15mm
KTI41616 - 16mm
KTI41617 - 17mm
KTI41618 - 18mm
KTI41619 - 19mm



High Polish Professional Metric Wrenches 12-point

Professional series metric wrench features high-polish, smooth-finish, heat-treated chrome vanadium steel. Tool is longer than standard combination wrench to enable access to hard-to-reach places. All wrenches are marked with part number and size for ease of identification and come with a lifetime warranty.

Sold separately:

KTI41807 - 7mm
KTI41808 - 8mm
KTI41809 - 9mm
KTI41810 - 10mm
KTI41811 - 11mm
KTI41812 - 12mm
KTI41813 - 13mm
KTI41814 - 14mm

KTI41815 - 15mm
KTI41816 - 16mm
KTI41817 - 17mm
KTI41818 - 18mm
KTI41819 - 19mm
KTI41820 - 20mm
KTI41821 - 21mm
KTI41822 - 22mm

KTI41823 - 23mm
KTI41824 - 24mm
KTI41825 - 25mm
KTI41826 - 26mm
KTI41827 - 27mm
KTI41828 - 28mm
KTI41829 - 29mm
KTI41830 - 30mm

KTI41831 - 31mm
KTI41832 - 32mm
KTI41833 - 33mm
KTI41834 - 34mm
KTI41835 - 35mm
KTI41836 - 36mm



High Polish Professional Metric Wrenches 12-point Short

Professional series metric wrenches features high-polish, smooth-finish, heat-treated chrome vanadium steel. Wrenches sized from 8-18mm. 12-point hex on all box ends.

Sold separately:

KTI41708 - 8mm
KTI41710 - 10mm
KTI41712 - 12mm
KTI41713 - 13mm

KTI41714 - 14mm
KTI41715 - 15mm
KTI41717 - 17mm
KTI41718 - 18mm



Ratcheting **Metric**



Ratcheting Metric Wrenches

Ratcheting box end needs as little as 5 degrees to move fastener. Designed to reduce fastener rounding. Wrenches feature a sleek head design for tight access points and all metal construction for durability and strength. All KTI wrenches carry a lifetime warranty.

Sold separately:

KTI45508 - 8mm
KTI45510 - 10mm

KTI45512 - 12mm
KTI45513 - 13mm

KTI45514 - 14mm
KTI45515 - 15mm
KTI45518 - 18mm



Ratcheting Reversible Metric Wrenches

Enjoy the speed of a ratchet with the accessibility of a wrench in this version with a reversing mechanism. Ratcheting box end needs as little as 5 degrees to move fastener. Reduce fastener rounding. Wrenches feature a sleek head design for tight access points and all metal construction for durability and strength.

Sold separately:

KTI45608 - 8mm
KTI45609 - 9mm
KTI45610 - 10mm
KTI45611 - 11mm
KTI45612 - 12mm
KTI45613 - 13mm

KTI45614 - 14mm
KTI45615 - 15mm
KTI45616 - 16mm
KTI45617 - 17mm
KTI45618 - 18mm

KTI45619 - 19mm
KTI45620 - 20mm
KTI45621 - 21mm
KTI45622 - 22mm
KTI45624 - 24mm



X-Long Double Box Ratcheting / Flexible / Reversible Spline Metric Wrenches

This extra-long, flexible and reversible double box ratcheting wrench is forged of chrome vanadium steel and heat-treated for durability. It features a 72-tooth design with a high-polish finish and is nearly 40% longer. Ratcheting box end needs as little as 5 degrees to move fastener. Sleek head design and slim dimensions further ease of working in confined areas.

Sold separately:

KTI43510 - 8mm x 10mm
KTI43513 - 12mm x 13mm
KTI43515 - 14mm x 15mm
KTI43518 - 16mm x 18mm
KTI43519 - 17mm x 19mm



Wrenches

Open-End | Fractional

Open-end High Polish Fractional Wrenches

Professional series fractional wrenches features high-polish, smooth-finish, heat-treated chrome vanadium steel. Lifetime warranty.

Sold separately:

KTI42316 - 1/2" x 9/16"

KTI42318 - 9/16" x 5/8"

KTI42320 - 5/8" x 3/4"

KTI42348 - 1-1/2" x 1-5/8"



**LIFETIME
WARRANTY***

Flare Nut Wrenches Fractional

Made of heat-treated steel. Available individually or as part of a set. Each socket is marked with size for ease of use. Lifetime warranty. Ideal for gas, brake and air conditioning lines, flare wrenches provide more power and torque where needed. Tools manufactured with high-polished, heat-treated chrome vanadium.

Sold separately:

KTI44412 - 3/8" x 7/16"

KTI44416 - 1/2" x 9/16"

KTI44420 - 5/8" x 11/16"



**LIFETIME
WARRANTY***

Open-End | Metric

Open-end High Polish Metric Wrench

Professional series metric wrench features high-polish, smooth finish, heat-treated chrome vanadium steel. Lifetime warranty.

Sold separately:

KTI42818 - 16mm x 18mm



**LIFETIME
WARRANTY***

Flare Nut Wrenches Metric

Made of heat-treated steel. Available individually or as part of a set. Each socket is marked with size for ease of use. Lifetime warranty. Ideal for gas, brake and air conditioning lines, flare wrenches provide more power and torque where needed. Tools manufactured with high-polished, heat-treated chrome vanadium. Lifetime warranty.

Sold separately:

KTI44910 - 10mm x 12mm

KTI44913 - 13mm x 14mm

KTI44917 - 15mm x 17mm



**LIFETIME
WARRANTY***

Combination **Fractional Sets**



KTI41011 11-Piece Combination Wrench Set Raised Panel Fractional 3/8" to 1"

Made of drop forged steel, wrenches are chrome-plated and heat-treated to achieve maximum wear. A raised panel provides additional strength and durability. Eleven-piece fractional set includes sizes 3/8", 7/16", 1/2", 9/16", 5/8", 11/16", 3/4", 13/16", 7/8", 15/16" and 1". Packaged in kit bag organizer. Available individually.



KTI41013 13-Piece Combination Wrench Set Raised Panel Fractional 1/4" to 1"

Made of drop forged steel, wrenches are chrome-plated and heat-treated to achieve maximum wear. A raised panel provides additional strength and durability. Thirteen-piece fractional set includes sizes 1/4", 5/16", 3/8", 7/16", 1/2", 9/16", 5/8", 11/16", 3/4", 13/16", 7/8", 15/16" and 1". Packaged in heavy duty kit bag organizer. Available individually.



KTI41014 14-Piece Combination Wrench Set Raised Panel Fractional 3/8" to 1-1/4"

Made of drop forged steel, wrenches are chrome-plated and heat-treated to achieve maximum wear. A raised panel provides additional strength and durability. Fourteen-piece fractional set includes sizes 3/8", 7/16", 1/2", 9/16", 5/8", 11/16", 3/4", 13/16", 7/8", 15/16", 1", 1-1/16", 1-1/8" and 1-1/4". Packaged in kit bag organizer. Available individually.



KTI41016 16-Piece Combination Wrench Set Raised Panel Fractional 1/4" to 1-1/4"

Made of drop forged steel, wrenches are chrome-plated and heat-treated to achieve maximum wear. A raised panel provides additional strength and durability. Sixteen-piece fractional set includes sizes 1/4", 5/16", 3/8", 7/16", 1/2", 9/16", 5/8", 11/16", 3/4", 13/16", 7/8", 15/16", 1", 1-1/16", 1-1/8" and 1-1/4". Packaged in kit bag organizer. Available individually.



KTI41004 4-Piece Jumbo Wrench Set Raised Panel Fractional 2-1/8" to 2-1/2"

KTI's jumbo wrenches, made of drop forged steel, are chrome-plated and heat-treated to achieve maximum wear. A raised panel provides additional strength and durability. Jumbo wrenches are designed specifically to meet the needs of the professional who services heavy-duty trucks, tractors and commercial equipment. Four-piece set includes sizes 2-1/8", 2-1/4", 2-3/8", 2-1/2". Available individually.



KTI41006 6-Piece Jumbo Wrench Set Raised Panel Fractional 1-3/8" to 2"

Jumbo wrenches, made of drop forged steel, are chrome-plated and heat-treated to achieve maximum wear. A raised panel provides additional strength and durability. Jumbo wrenches are designed specifically to meet the needs of the professional who services heavy-duty trucks, tractors and commercial equipment. Six-piece set includes sizes 1-3/8", 1-1/2", 1-5/8", 1-3/4", 1-7/8", 2".



Wrenches

Combination Fractional Sets



KTI41300 9-Piece Wrench Set High Polish Fractional 3/8" to 7/8"

Nine-piece professional series fractional set features high-polish, smooth-finish, heat-treated chrome vanadium steel. Tools are longer than standard combination wrenches to enable access to hard-to-reach places. Wrenches sized from 3/8"-7/8". Packaged in kit bag. Available individually.

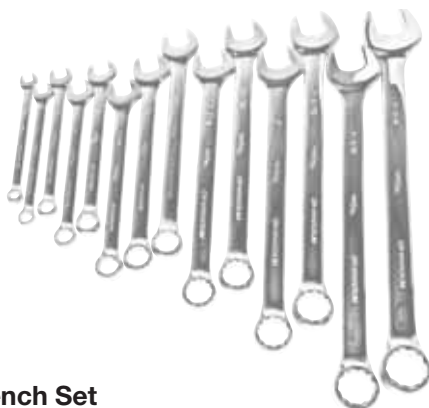

KTI41304 14-Piece Wrench Set High Polish Fractional 3/8" to 1-1/4"

14-piece professional series fractional set features high-polish, smooth-finish, heat-treated chrome vanadium steel. Tools are longer than standard combination wrenches to enable access to hard-to-reach places. Wrenches sized from 3/8"-1-1/4". Packaged in kit bag. Available individually.



KTI44003 3-Piece Wrench Set Flare Nut

Ideal for gas, brake and air conditioning lines, flare wrenches provide more power and torque where needed. Tools manufactured with high-polished, heat-treated chrome vanadium. Three-piece set includes double-ended wrenches sized 3/8" x 7/16", 1/2" x 9/16" and 5/8" x 11/16". Available individually.



KTI41305 24 Piece High Polish Combination Wrench Set

- Professional Series Fractional Wrench Set
- High-polish, smooth-finish, heat-treated chrome-vanadium steel
- Heavy duty pocketed roll pouch with two velcro bands
- Wrench sizes: 1/4", 5/16", 11/32", 3/8", 7/16", 1/2", 9/16", 5/8", 11/16", 3/4", 13/16", 7/8", 15/16", 1", 1-1/16", 1-1/8", 1-3/16", 1-1/4", 1-5/16", 1-3/8", 1-7/16", 1-1/2", 1-9/16" and 1-5/8"



KTI41200 7-Piece Combination Wrench Set Fractional Short 3/8" to 3/4"

Seven-piece professional series fractional set features high-polish, smooth-finish, heat-treated chrome vanadium steel. Wrenches sized from 3/8" to 3/4". 12-point hex on all box ends. Packaged in kit bag. Available individually.



Ratcheting Fractional Sets



KTI45400 7-Piece Ratcheting Wrench Set Fractional 5/16" to 3/4"

This 7 piece fractional set includes sizes 5/16, 3/8", 7/16", 1/2", 9/16", 5/8" and 3/4". Ratcheting box end needs as little as 5 degrees to move fastener. Designed to reduce fastener rounding. Wrenches feature a sleek head design for tight access points and all metal construction for durability and strength. All KTI wrenches carry a lifetime warranty.



KTI45900 13-Piece Ratcheting Reversible Wrench Set Fractional 1/4" to 1"

Enjoy the speed of a ratchet with the accessibility of a wrench in this version with a reversing mechanism. This 13 piece fractional set includes sizes 1/4", 5/16, 3/8", 7/16", 1/2", 9/16", 5/8", 11/16", 3/4", 13/16", 7/8", 15/16" and 1". Ratcheting box end needs as little as 5 degrees to move fastener. Reduce fastener rounding. Wrenches feature a sleek head design for tight access points and all metal construction for durability and strength. All KTI wrenches carry a lifetime warranty.



KTI45901 9 Piece Reversible Ratcheting SAE Wrench Set

Reversible Ratcheting Combination Wrench Set, 1/4" - 3/4". Ratcheting box end needs as little as 5 degrees to move fastener. Reduce fastener rounding. Wrenches feature a sleek head design for tight access points and all metal construction for durability and strength. All KTI wrenches carry a lifetime warranty.



KTI45902 7 Piece Reversible Ratcheting SAE Wrench Set

- All metal construction for durability and strength
- Ratcheting box end needs as little as 5 degrees to move fastener
- Designed to reduce fastener rounding
- Sleek head design for tight access points

7 piece Reversible, Ratcheting Combination Wrench Set includes: 5/16", 3/8", 7/16", 1/2", 9/16", 5/8" and 3/4"



KTI43100 4-Piece Fractional X-Long Double Box Ratcheting Flexible Reversible Spline Wrench Set

These extra-long, flexible and reversible double box ratcheting wrenches are forged of chrome vanadium steel and heat-treated for durability. Wrenches in this 4-piece set feature a 72-tooth design with a high-polish finish and are nearly 40% longer. Ratcheting box end needs as little as 5 degrees to move fastener. Sleek head design and slim dimensions further ease of working in confined areas. Set includes the following fractional sizes: 5/16" x 3/8", 7/16" x 1/2", 9/16" x 5/8" and 11/16" x 3/4". All KTI wrenches carry a lifetime warranty. Packaged in a blow-molded case.



Wrenches

Combination Metric Sets



KTI41513 **13-Piece Combination Wrench Set Raised Panel Metric 7mm to 19mm**

Made of drop forged steel, wrenches are chrome-plated and heat-treated to achieve maximum wear. A raised panel provides additional strength and durability. Thirteen-piece metric set includes sizes 7mm, 8mm, 9mm, 10mm, 11mm, 12mm, 13mm, 14mm, 15mm, 16mm, 17mm, 18mm and 19mm. Packaged in kit bag organizer. Available individually.

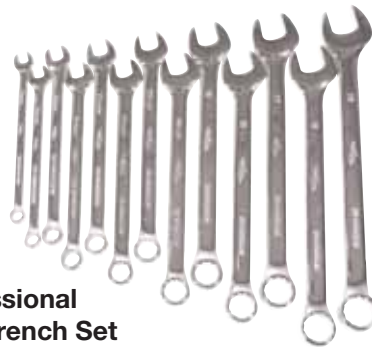

KTI41800 **13-Piece Professional Combination Wrench Set High Polish Metric 7mm to 19mm**

13-piece professional series metric set features high-polish, smooth-finish, heat-treated chrome vanadium steel. Tools are longer than standard combination wrenches to enable access to hard-to-reach places. Wrenches sized from 7mm-19mm. Packaged in kit bag. Available individually.



KTI41700 **7-Piece Combination Wrench Set Metric Short 10mm to 18mm**

Seven-piece professional series metric set features high-polish, smooth-finish, heat-treated chrome vanadium steel. Wrenches sized from 10mm-18mm. 12-point hex on all box ends. Packaged in kit bag. Available individually.



KTI41801 **9-Piece Professional Combination Wrench Set High Polish Metric 20mm to 28mm**

9-piece professional series metric set features high-polish, smooth-finish, heat-treated chrome vanadium steel. Tools are longer than standard combination wrenches to enable access to hard-to-reach places. Wrenches sized from 20mm through 28mm. Also available individually.



KTI44500 **3-Piece Flare Nut Wrench Set Metric**

Ideal for gas, brake and air conditioning lines, flare wrenches provide more power and torque where needed. Tools manufactured with high-polished, heat-treated chrome vanadium. Three-piece set includes double-ended wrenches sized 10mm x 12mm, 13mm x 14mm and 15mm x 17mm. Available individually.



KTI41802 **8-Piece Professional Combination Wrench Set High Polish Metric 29mm to 36mm**

8-piece professional series metric set features high-polish, smooth-finish, heat-treated chrome vanadium steel. Tools are longer than standard combination wrenches to enable access to hard-to-reach places. Wrenches sized from 29mm through 36mm. Also available individually.



Ratcheting Metric Sets



KT145500
7-Piece
Ratcheting Wrench Set
Metric 8mm - 18mm

7 Piece metric set includes sizes 8mm, 10mm, 12mm, 13mm, 14mm, 15mm and 18mm. Ratcheting box end needs as little as 5 degrees to move fastener. Designed to reduce fastener rounding. Sleek head design for tight access points and all metal construction for durability and strength. All KTI wrenches carry a lifetime warranty.



KT145600
16-Piece
Ratcheting Reversible Wrench Set
Metric 8mm - 24mm

Enjoy the speed of a ratchet with the accessibility of a wrench in this version with a reversing mechanism. This 16 piece metric set includes sizes 8mm, 9mm, 10mm, 11mm, 12mm, 13mm, 14mm, 15mm, 16mm, 17mm, 18mm, 19mm, 20mm, 21mm, 22mm, 24mm, . Ratcheting box end needs as little as 5 degrees to move fastener. Reduce fastener rounding. Wrenches feature a sleek head design for tight access points and all metal construction for durability and strength. All KTI wrenches carry a lifetime warranty.



KT145601
12 Piece Reversible
Ratcheting Metric Wrench Set

Reversible Ratcheting Metric Combination Wrench Set, 8-19mm



KT145602
7 Piece Reversible
Ratcheting Metric Wrench Set

Reversible Ratcheting Metric Combination Wrench Set, 8-18mm



KT143500
5-Piece Metric
X-Long Double Box Ratcheting
Flexible Reversible Spline Wrench Set

These extra-long, flexible and reversible double box ratcheting wrenches are forged of chrome-vanadium steel and heat-treated for durability. Wrenches in this 5-piece set feature a 72-tooth design with a high polish finish and are nearly 40% longer. Ratcheting box end needs as little as 5 degrees to move fastener. Sleek head design and slim dimensions further ease of working in confined areas.

Set includes the following metric sizes: 8mm x 10mm, 12mm x 13mm, 14mm x 15mm, 16mm x 18mm and 17mm x 19mm. All KTI wrenches carry a lifetime warranty. Packaged in a blow-molded case.



Wrenches

Adjustable Wrenches

Manufactured with drop-forged, heat-treated alloy steel for maximum strength and light weight. Chrome plated.

Sold separately:

KTI48004 - 4" jaw capacity: 1/2"

KTI48006 - 6" jaw capacity: 3/4"

KTI48008 - 8" jaw capacity: 1"

KTI48010 - 10" jaw capacity: 1-13/16"

KTI48012 - 12" jaw capacity: 1-1/2"

KTI48015 - 15" jaw capacity: 1-7/8"

KTI48018 - 18" jaw capacity: 2-1/4"

**LIFETIME
WARRANTY***



KTI48006GT

Adjustable Wrench 6" Long with Grip

Taiwan



KTI48004T

Adjustable Wrench 4"

- 1/2" jaw capacity
- Drop-forged, heat-treated alloy steel for maximum strength and light weight
- Chrome Vanadium steel



KTI48012BTW

Adjustable Wrench 12" Black

- Chrome vanadium drop forged steel
- Adjustable opening to 1-1/2"
- Length 12"

Adjustable Wrench 12" Black. Chrome Vanadium drop forged steel. Length 12". Opens to 1-1/2".



KTI49309

Auto Wrench 9" (Monkey Wrench)

- Adjustable up to 2-1/2"
- Black Oxide



KTI49315

Auto Wrench 15" (Monkey Wrench)

- Adjustable up to 3-1/4 inches
- Black oxide

Aluminum Pipe Wrenches

KTI's aluminum pipe wrench weighs 40% less than its cast iron counterpart. A lighter tool is easier to handle and causes less hand fatigue and arm stress. Wrench features strong hardened jaws, nuts and teeth, and drop forged steel jaws. A versatile head design provides a flat surface for hammering.

Sold separately:

KTI49112 - 12" jaw capacity: 2-1/4"

KTI49114 - 14" jaw capacity: 2-5/8"

KTI49118 - 18" jaw capacity: 3-1/4"

KTI49124 - 24" jaw capacity: 3-1/2"

KTI49136 - 36" jaw capacity: 4"

LIFETIME WARRANTY*



Pipe Wrenches

KTI's pipe wrench is constructed from the highest grade cast iron, forged and heat-treated to ensure maximum durability. Tough red enamel finish. Tool is strong and versatile.

Sold separately:

KTI49008 - 8" jaw capacity: 1-1/2"

KTI49010 - 10" jaw capacity: 1-7/8"

KTI49012 - 12" jaw capacity: 2-3/8"

KTI49014 - 14" jaw capacity: 1-1/2"

KTI49018 - 18" jaw capacity: 3"

KTI49024 - 24" jaw capacity: 1-1/2"

KTI49036 - 36" jaw capacity: 3-1/2"

LIFETIME WARRANTY*



KTI49000

4-Piece Pipe Wrench Set

4-piece set includes 8", 10", 14" and 18" pipe wrenches. Tools boast strong, durable and versatile cast iron with drop forged steel jaws. Perfect for a variety of applications.



LIFETIME WARRANTY*



KTI49400

Universal Drum Bung Wrench

- Bronze Non-Sparking



KTI49405

Universal Drum Plug Bung Wrench

- Ductile

Wrenches

Hex Key Sets



KTI71400 7-Piece Folding Hex Bit Set Fractional

Fold-up sets include a variety of popular sizes in one convenient handle. Fold a key out to a right angle to get maximum leverage. Fold a key out completely to operate like a screwdriver. Fold-up sets are compact and easily fit in your pocket or tool box. Includes 1/8" to 3/8" fractional sizes.

**LIFETIME
WARRANTY***



KTI71475 7-Piece Folding Hex Key Set Metric

Fold-up sets include a variety of popular sizes in one convenient handle. Fold a key out to a right angle to get maximum leverage. Fold a key out completely to operate like a screwdriver. Fold-up sets are compact and easily fit in your pocket or tool box. Includes 2.5mm to 10mm metric sizes.

**LIFETIME
WARRANTY***

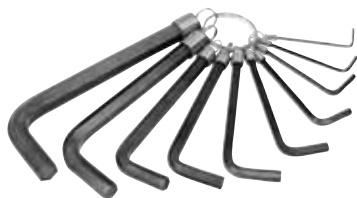

KTI71420 10-Piece Hex Key Set on Ring Fractional

Hex keys featuring quality workmanship and value. Manufactured with heat-treated alloy steel with black finish. Precision formed to exact dimensional tolerances for precise fit. Includes fractional "L" hex sizes from 1/16" to 3/8". Carded on a ring.

**LIFETIME
WARRANTY***

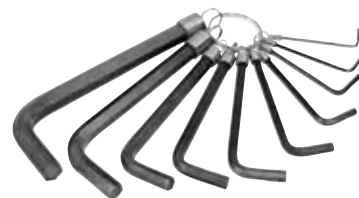

KTI71480 10-piece Hex Key Set on Ring Metric

Hex keys featuring quality workmanship and value. Manufactured with heat-treated alloy steel with black finish. Precision formed to exact dimensional tolerances for precise fit. Includes metric "L" hex sizes from 1.5mm to 10mm. Carded on a ring.

**LIFETIME
WARRANTY***

KTI71425 25-Piece Hex Key Set (in pouch)

Hex keys featuring quality workmanship and value. Set features a convenient package design that provides easy transport and storage. Manufactured with heat-treated alloy steel with black finish. Precision formed to exact dimensional tolerances for precise fit. Includes long fractional "L" hex sizes from 1/16" to 3/8" and short metric "L" hex sizes from 1.5mm to 10mm. Packaged in roll-up storage pouch.

**LIFETIME
WARRANTY***

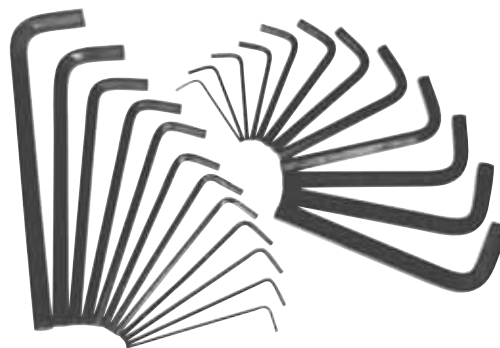



Pliers, Hammers, Punches, Chisels and Files

Pliers, Hammers, Punches, Chisels and Files

Needle Nose Pliers

Needle nose pliers reach into even the tightest places. Tool features side cutter and non-slip vinyl grip. Manufactured from heat-treated chrome vanadium for durability. Each sold separately.

Sold separately:

KT151006 - 6"

KT151206 - 6" bent end

KT151007 - 7"

KT151008 - 8"

**LIFETIME
WARRANTY***



KT151006T

**Needle Nose Plier 6",
with Side Cutter, Vinyl Grips**

Slip Joint Pliers

Designed for gripping and turning round objects. Manufactured from chrome vanadium steel with chrome finish. Ergonomic vinyl handle for user comfort. Available in three sizes.

Sold separately:

KT153004 - 4"

KT153006 - 6"

KT153008 - 8"

**LIFETIME
WARRANTY***



KT153006T

Slip Joint Pliers 6" Long



Groove Joint Pliers

Can be adjusted to grip or turn objects. Ideal for grasping nuts or pipe. Manufactured from chrome vanadium steel with chrome finish. Ergonomic vinyl handle for user comfort. Available in three sizes.

Sold separately:

KT154006 - 6"

KT154010 - 10"

KT154012 - 12"

**LIFETIME
WARRANTY***



KT151103

3-Piece

11" Needle Nose Plier Set

These extra long needle nose pliers reach into even the tightest places. Pliers manufactured with heat-treated chrome vanadium steel for long wear. Tools feature soft comfort grip handles. Packaged in handy storage pouch. Set includes 15 degree offset, 45 degree bent nose and 90 degree bent nose.

Set includes (also available individually):

KT151111 - 90° bent nose

KT151211 - 45° offset

KT151311 - 15° offset



**LIFETIME
WARRANTY***

Diagonal Cutters

Manufactured from chrome vanadium steel. Ergonomic handle for user comfort. Available in three sizes.

Sold separately:

KT152006 - 6"

KT152007 - 7"

KT152107 - 7" heavy-duty

**LIFETIME
WARRANTY***



KT152009

Heavy Duty Cable Cutters

- 9-1/4 Length
- For cutting copper and aluminum cable
- Not for use on ACSR cable or steel wire.



KT154050

Cannon Plug Pliers

Cannon plug pliers fit A-N electrical connectors from 3/4" to 2-1/2" Slip-joint design with 4 adjustment positions and dipping handle. Soft, non-marring white nylon jaw inserts with serrations. Jaw width: 3/8" and open capacity: 3/4" to approximately 2-1/2". Plier length: 10"





KT158705
Locking Plier
Curved Jaw 5"

Curved-jaw pliers apply maximum torque for any application. Manufactured from high-grade heat-treated alloy steel for strength and durability. Hardened teeth provide superior grip at any angle. Adjusting screw tightens to adjust pressure for a secure, firm grip every time. Quick-release trigger. Overall length: 5" Meets or exceeds ANSI standards. Lifetime warranty.

LIFETIME
WARRANTY*



KT158707
Locking Plier
Curved Jaw 7"

Curved-jaw pliers apply maximum torque for any application. Manufactured from high-grade heat-treated alloy steel for strength and durability. Hardened teeth provide superior grip at any angle. Adjusting screw tightens to adjust pressure for a secure, firm grip every time. Quick-release trigger. Overall length: 7" Meets or exceeds ANSI standards. Lifetime warranty.

LIFETIME
WARRANTY*



KT158710
Locking Plier
Curved Jaw 10"

Curved-jaw pliers apply maximum torque for any application. Manufactured from high-grade heat-treated alloy steel for strength and durability. Hardened teeth provide superior grip at any angle. Adjusting screw tightens to adjust pressure for a secure, firm grip every time. Quick-release trigger. Overall length: 10" Meets or exceeds ANSI standards. Lifetime warranty.

LIFETIME
WARRANTY*



KT158717
Locking Plier
Straight Jaw 7"

Straight-jaw pliers apply maximum torque for flat, square or hex applications. Manufactured from high-grade heat-treated alloy steel for strength and durability. Hardened teeth provide superior grip at any angle. Adjusting screw tightens to adjust pressure for a secure, firm grip every time. Quick-release trigger. Overall length: 7" Meets or exceeds ANSI standards. Lifetime warranty.

LIFETIME
WARRANTY*



KT158809
Locking Welding Clamp Plier 9"

Locking welding clamp features U-shaped jaws for improved visibility and less obstruction to work area. Perfect for welding applications or securing awkward-shaped work pieces. Manufactured from high-grade heat-treated alloy steel for strength and durability. Superior grip to hold work pieces in proper alignment. Adjusting screw tightens to adjust pressure for a secure, firm grip every time. Quick-release trigger. Overall length: 9" Meets or exceeds ANSI standards. Lifetime warranty.

LIFETIME
WARRANTY*



KT158811
Locking C-Clamp
Plier 11"

Locking C-clamp plier features wide-opening jaws to accommodate a variety of shapes and sizes for any application. Manufactured from high-grade heat-treated alloy steel for strength and durability. Adjusting screw tightens to adjust pressure for a secure, firm grip every time. Quick-release trigger. Overall length: 11" Meets or exceeds ANSI standards. Lifetime warranty.

LIFETIME
WARRANTY*

Pliers, Hammers, Punches, Chisels and Files

KTI55001

5-Piece Reversible Snap Ring Plier Set

Set includes: short straight small tip (2 pieces); long straight large tip; short 90 degree small tip; and long 90 degree large tip. These versatile, heavy duty pliers are designed for the removal and installation of either internal or external snap rings on a wide range of applications. Packaged in blow-molded case. Available individually.

Set includes (also available individually):

KTI55012 - short, straight small tip (2 pc.) **KTI55034** - long, straight large tip
KTI55912 - short 90 degree small tip **KTI55934** - long 90 degree large tip



KTI55112

12-Piece Reversible Snap Ring Plier Set

Set includes the four most popular tip sizes in straight, 45 and 90 degree angle configurations. These versatile, heavy duty pliers are designed for the removal and installation of either internal or external snap rings on a wide range of applications. Packaged in blow-molded case. Available individually. Made in U.S.A.

Set includes (also available individually):

KTI55120 - straight tip .038 **KTI55121** - straight tip .047
KTI55122 - straight tip .070 **KTI55123** - straight tip .090
KTI55130 - 45 bent tip .038 **KTI55131** - 45 bent tip .047
KTI55132 - 45 bent tip .070 **KTI55133** - 45 bent tip .090
KTI55140 - 90 bent tip .038 **KTI55141** - 90 bent tip .047
KTI55142 - 90 bent tip .070 **KTI55143** - 90 bent tip .090



KTI72505

5-Piece File Set

Set includes: 6" mill file; 10" mill file; 8" bastard file; 8" half-round file; and 8" round file.

Set includes (also available individually):

KTI72512 - 6" mill file
KTI72514 - 10" mill file
KTI72523 - 8" bastard file
KTI72543 - 8" half-round file
KTI72553 - 8" round file





KTI71771
13 oz. Fiberglass Claw Hammer
 13 Ounce with Fiberglass Handle and Rubber Grip



Solid Brass Hammers
 Non-sparking brass hammer prevents damage to delicate parts. Made in U.S.A.

Sold separately:
KTI71782 - 27oz., 1-1/16" head diameter
KTI71783 - 48oz., 1-1/4" head diameter



Brass Hammers with Hickory Handles
 Non-sparking brass hammer prevents damage to delicate parts. Made in U.S.A.

Sold separately:
KTI71714 - 16oz., 1-1/4" head diameter
KTI71715 - 24oz., 1-1/4" head diameter
KTI71733 - 32oz., 1-1/2" head diameter



KTI71751
Rubber Mallet 24oz.
 Non-marking rubber mallet. Weight: 24 oz.



Ball Pein Hammers
 Hammer features drop forged, heat-treated steel head and fiberglass handle for strength and reliability. Tool boasts contoured, nonslip rubber grip for user comfort.

Sold separately:
KTI71708 - 8oz.
KTI71725 - 24oz.

KTI71716 - 16oz.
KTI71732 - 32oz.



KTI71704
4 oz Ball Pein Hammer
 • 4 oz with Fiberglass Handle and Rubber Grip



KTI71724
4lb. Cross Pein Hammer
 Fiberglass handle and rubber grip. Overall length: 15-1/4".



Pliers, Hammers, Punches, Chisels and Files

15-Piece Punch & Chisel Set

Set includes five pin punches, five taper punches, three chisels and two center punches. Packaged in your choice of plastic tray or kit bag. Components available individually. **KTI72901** (in tray) or **KTI72901K** (in kit bag)

Pin Punches

KTI72911 - 3/32"
KTI72912 - 1/8"
KTI72913 - 5/32"
KTI72914 - 3/16"
KTI72915 - 1/4"

Taper Punches

KTI72921 - 3/32"
KTI72922 - 1/8"
KTI72923 - 5/32"
KTI72924 - 3/16"
KTI72925 - 1/4"

Chisels

KTI73012 - 3/8"
KTI73016 - 1/2"
KTI73020 - 5/8"

Center Punches

KTI72931 - 1/8"
KTI72932 - 3/16"



KTI72901 (in tray) or **KTI72901K** (in kit bag)



LIFETIME WARRANTY*

KTI72900

6-Piece Pin Punch Set

Sizes include: 3/32", 1/8", 5/32", 3/16", 1/4" and 5/16". Packaged in plastic tray. Available individually.

Set includes (also available individually):

KTI72911 - 3/32"
KTI72912 - 1/8"
KTI72913 - 5/32"
KTI72914 - 3/16"
KTI72915 - 1/4"
KTI72916 - 5/16"



LIFETIME WARRANTY*

KTI73000

5-piece Chisel Set

Sizes include: 3/8", 1/2", 5/8", 3/4" and 7/8". Packaged in plastic tray. Available individually.

Set includes (also available individually):

KTI73012 - 3/8"
KTI73016 - 1/2"
KTI73020 - 5/8"
KTI73024 - 3/4"
KTI73028 - 7/8"



LIFETIME WARRANTY*



KTI70002

Automatic Center Punch

Spring loaded with impact mechanism. Push in and it makes its mark. Brass tone. Carded.

LIFETIME WARRANTY*

KTI72980

4-Piece Brass Punch Set

Set includes sizes: 3/8", 1/2", 5/8", and 3/4". Tools feature knurled handles. Designed for rugged shop environment. Packaged in vinyl case. Made in U.S.A.

Set includes (also available individually):

KTI72982 - 3/8" punch
KTI72984 - 1/2" punch
KTI72986 - 5/8" punch
KTI72988 - 3/4" punch



LIFETIME WARRANTY*



Specialty Tools

Specialty Tools

Tow Straps

Heavy-duty nylon web construction with reinforced stitching. Available with looped end or forged hooks. Abrasion and cut resistant. Strongest, longest-lasting webbing tow straps on the market. Meet or exceed all DOT specifications.

Styles and sizes available:

KTI73801 - Forged hooks	7,000 lb. capacity	2" width	10' length
KTI73802 - Forged hooks	10,000 lb. capacity	2" width	15' length
KTI73803 - Forged hooks	10,000 lb. capacity	2" width	25' length
KTI73810 - Looped ends	15,000 lb. capacity	2" width	20' length
KTI73811 - Looped ends	30,000 lb. capacity	3" width	20' length
KTI73812 - Looped ends	30,000 lb. capacity	3" width	30' length



Heavy-duty Tow Straps

Heavy duty nylon web construction with reinforced stitching and looped ends. Abrasion and cut resistant. Strongest, longest-lasting webbing tow straps on the market. Meet or exceed all DOT specifications.

Sizes available:

KTI73813 - Looped ends	40,000 lb. capacity	4" width	30' length
KTI73814 - Looped ends	60,000 lb. capacity	6" width	30' length



Stretch Cords

Braided cover prevents abrasions and provides added durability. Vinyl covered hooks prevents scratches. Designed for professional use.

Sizes available:

KTI73830 - General purpose	3/8" diameter	18" length	Yellow	10-pack
KTI73831 - General purpose	3/8" diameter	24" length	Yellow	10-pack
KTI73832 - General purpose	3/8" diameter	30" length	Yellow	10-pack
KTI73833 - General purpose	13/32" diameter	40" length	Yellow	10-pack
KTI73834 - General purpose	13/32" diameter	48" length	Yellow	10-pack



Rubber Straps

Sizes available:

KTI73849 - EPDM Rubber Strap	3/8" wide	15" length	22" max stretch	10-pack
KTI73850 - EPDM Rubber Strap	3/8" wide	21" length	31" max stretch	10-pack
KTI73851 - EPDM Rubber Strap	3/8" wide	31" length	46" max stretch	10-pack



Tie Downs & Straps

Styles and sizes available:

KTI73862 - Ratcheting Tie Down (endless loop)	900 lb. capacity	1" width	13' length	1-pack
KTI73861 - Ratcheting Tie Down (PVC-coated hooks)	900 lb. capacity	1" width	15' length	1-pack
KTI73870 - Ratcheting Tie Down (PVC-coated hooks) (each)	900 lb. capacity	1" width	15' length	4-pack
KTI73864 - Motorcycle Tie Down (1 chrome and 1 PVC-coated hook)	1,200 lb. capacity	1" width	6' length	1-pack
KTI73871 - Universal Tie Down (PVC-coated hooks)	900 lb. capacity	1" width	10' length	1-pack
KTI73873 - Cam Buckle Tie Down (Cam buckles)	900 lb. capacity	1" width	13' length	1-pack



KTI73862



KTI73861



KTI73864



KTI73871



KTI73873

K-Tool International recommends that the working load never exceed 1/3 of the rated capacity. Any strap assembly is only as strong as its weakest component, including the point of attachment or anchor.

Q-Bond®

KTI90002

Q-BOND Adhesive Kit

- Ultra-strong adhesive and reinforcing powders
- Repairs almost anything!
- Rock solid in 10 seconds!
- Q-Bond repairs are able to be grinded, filed, sanded and even painted!
- Includes 2 Q-BOND adhesive; 1 black reinforcing powder; 1 grey reinforcing powder



Q-BOND can be used just as an adhesive or with the reinforcing powders that will help to repair almost anything. The Q-BOND kit includes two (2) bottles Q-BOND adhesive (0.35oz/10ml); one (1) bottle black reinforcing powder for plastics; one (1) bottle grey reinforcing powder for metals.



KTI90003

Q-Bond Adhesive Kit 10 Pack With Display

- New package design with 10 kits per display - Each kit contains 2 Q-Bond adhesives, 1 black reinforcing powder and 1 grey reinforcing powder
- Hang tabs for pegboard and rack displays
- Dimensions: 11.5" x 6.5" x 6.5"

Tape Measures

- 3/4" Wide
- SAE and Metric Markings
- Top Lock
- Automatic Return



KTI72610 10 Foot Long Tape Measure
KTI72616 16 Foot Long Tape Measure

LIFETIME WARRANTY*

Tape Measures

Sold separately:
KTI72612 - 1/2" x 12'(3.5M) Fractional/Metric Graduations
KTI72625 - 3/4" x 25'(7.5M) Fractional/Metric Graduations



LIFETIME WARRANTY*



KTI73510 Black Electrical Tape

Roll measures 3/4" wide x 60'. Sold in sleeve of ten rolls.



KTI73560 Duct Tape

Multipurpose gray duct tape for numerous uses. Roll measures 2" wide x 60 yards. U.S.-made



KTI73550 Thread Sealing Tape

Each roll measures 1/2" wide x 260". Ideal for sealing threaded pipe. 5-pack.

Specialty Tools

KTI70004

4-Piece Putty Knife / Scraper Set

Four-piece set includes: 1" stiff edge; 1-1/2" stiff edge; 1-1/2" flex edge; and 3" flex edge. Use to apply adhesives, filler, compound, spackles and more. Ideal for removing paint, rust, gaskets, carbon, filler and undercoating. All blades are high carbon, heat-treated, tempered, polished to mirror finish and full tang. Tools fitted with grommeted brass, solvent-resistant, riveted wood handles. Features 15 degree sharp chisel edge on stiff scrapers.

Set includes (also available individually):

KTI70014 - Scraper Putty Knife 1" Stiff

KTI70015 - Scraper Putty Knife 1-1/2" Stiff

KTI70017 - Scraper Putty Knife 1-1/2" Flexible

KTI70018 - Scraper Putty Knife 3" Flexible



LIFETIME WARRANTY*

KTI70005

4-Piece Putty Knife / Scraper Set

This 4-piece scraper set features a combination of flexible and stiff scrapers for the needs of any automotive body application or home improvement job. Constructed of stainless steel blades that taper at tip to provide great flexibility and blade action. Ergonomic, comfort-grip, non-slip handles. Contains an upholstery tucking tool, 2" flexible scraper, 1.25" flexible scraper and 1.25" stiff chisel.

Set includes (also available individually):

KTI70006 - Putty Knife, Upholstery Tucking Tool with Stainless Steel Blade and Comfort Grip Handle

KTI70007 - Putty Knife, 2" Flexible with Stainless Steel Blade and Comfort Grip Handle

KTI70008 - Putty Knife, 1.25" Flexible with Stainless Steel Blade and Comfort Grip Handle

KTI70009 - Putty Knife, 1.25" Stiff Chisel with Stainless Steel Blade and Comfort Grip Handle



LIFETIME WARRANTY*

KTI70023

4-Piece Scraper Set

Set includes: stubby scraper; 1" carbon scraper; combination offset scraper; and 5/8" scraper. Also available individually. U.S.-made

Set includes (also available individually):

KTI70019 - Stubby Scraper

KTI70021 - 1" Carbon Scraper

KTI70022 - Combination Offset Scraper

KTI70027 - 5/8" Scraper



LIFETIME WARRANTY*

Scrapers

Professional quality and perfect for any application in the garage, shop or around the house. Multipurpose tool features stainless steel blade. High-quality wood handle for strength and durability. Lifetime warranty.

Sold separately:

KTI70024 - Scraper 3/4" Chisel - U.S.-made

KTI70026 - Scraper 1-1/2" Chisel - U.S.-made

KTI70025 - Scraper 1-1/2" Flexible - U.S.-made

KTI70028 - Putty Knife

KTI70029 - Scraper 3" Flexible - U.S.-made



except KTI70028

LIFETIME WARRANTY*

KTI70031

5-Piece Upholstery Clip Remover Set

This set combines the most popular individual upholstery tools into one master set. Includes both "U" and "V" clip styles of tools as well as a reverse U-blade door panel clip removal tool. This is a complete set for anyone working on car upholstery or for removing panels from dash or door. Comes in a thermoformed tray for easy storage in any tool box. Available individually.



Set includes (also available individually):

- KTI70032** - "V" Blade Door Panel Tool with Stainless Steel Blade
- KTI70033** - "U" Blade Door Panel Tool with Stainless Steel Blade
- KTI70034** - "U" Blade Mini Trim Panel Tool with Stainless Steel Blade
- KTI70035** - "V" Blade Mini Trim Panel Tool with Stainless Steel Blade
- KTI70036** - Reverse "U" Blade Door Panel Tool with Stainless Steel Blade



KTI70016

Mini Scraper

Grip-coated handle for better comfort and control. Angled tip for increased accuracy. Blade locks securely in place. Quick and easy blade changes. Reversible blade for safe storage. Includes one (1) single edge blade. Length: 4½". Assorted colors.

KTI70020

Long Handled Scraper

Extra-long scraper with contoured handle to reduce fatigue. The 1" blade is ideal for removing gaskets. Lightweight, durable construction.



KTI70540

Windshield Removing Tool

Facilitates removal of windshields and backlights by cutting sealant around windows. Each tool includes an extra replacement blade.



Replacement parts:

- KTI70541** - Replacement blade



Utility Brushes

Wood handle brushes have natural bristles not affected by thinners or other solvents.

Sold separately:

- KTI74005** - 1/2" width
- KTI74010** - 1" width
- KTI74015** - 1-1/2" width
- KTI74020** - 2" width
- KTI74025** - 2-1/2" width
- KTI74030** - 3" width



KTI70545

Professional Heavy-duty Windshield Knife

Features professional-grade construction from heavy-duty steel and aluminum. Knife is lightweight and easy-to-use. Extra-long reach to cut hardened urethane all the way down to the dash line and offers increased leverage and greater control for a safer, smoother cut. The padded, ergonomic handle also features storage space for replacement blades. Blades can be easily changed by releasing a simple one-screw retaining clip.



Replacement parts:

- KTI70546** - Replacement blades 6-pack



KTI74103

3-Piece Mini Brush Set

Set includes one brass, nylon and stainless steel brush. Features molded poly handles. Overall length: 7 inches.

Set includes (also available individually):

- KTI74106** - Brass
- KTI74107** - Nylon
- KTI74108** - Steel



Specialty Tools



KT173105 Utility Knife

Retractable 6" utility knife with extra blade storage in handle.

Replacement parts:

KT170546 - Replacement blades 6-pack



KT173102 Auto-loading Folding Utility Knife

- Quick Change Folding Utility Knife
- Folded length: 4.3125 inches
- Open Length: 6.5 inches
- Plastic body with rubber grip.
- Blade case with 3 blades included.



KT173104 Monster Utility Knife

This utility knife features a quick-change blade system equipped with six (6) snap-off blades. Always ready with a razor-sharp blade! Monster utility knife also features an extra-large, ergonomic grip for added control. Knife measures a whopping 8" x 2.5" x 1".

Replacement parts:

KT173104-1 - Replacement blades 10-pack



KT173103 Professional Safety Utility Knife

- Folded length: 4.375 inches
- Open Length: 7 inches
- Zinc body, ABS and rubber grip
- 3 blades included

Auto loading folding utility knife. Zinc body, ABS and rubber grip. Folded knife length is 4.375 inches, blade shaft length is 2.750 inches, open knife length is 7 inches. Black & Red handle. Three blades are included.



KT173155 Folding Knife Stainless Steel Satin Finish Blade

- Folding Knife Stainless Steel satin finish blade partially serrated blade with assist opening



KT173150 Folding Knife with Black Finish Blade

- Folding Knife with a 9Cr18MOV stainless steel black finish blade
- Partially serrated with assist opening and G10 handle.
- Folded knife length: 4.750", width: 1.438", height: .563".
- Open knife length: 8.4375".
- Blade shaft length: 3.6875".
- The pocket clip can be installed on either side of the knife handle.

Center Cut Bolt Cutters

- Heavy duty cutters
- Heat-treated chrome vanadium alloy jaws
- Specially designed curved handles for more efficient strength application and comfortable rubber handles for firm and safe grip

Sold separately:

KTI57124 - 24" Center Cut Bolt Cutter

KTI57130 - 30" Center Cut Bolt Cutter

KTI57136 - 36" Center Cut Bolt Cutter

Replacement parts:

KTI57224 - Replacement head 24"

KTI57236 - Replacement head 36"



Center Cut



Clipper Cut Bolt Cutters

- Blades are flush against one face for cutting against flat surfaces
- Heavy duty cutters
- Heat-treated chrome vanadium alloy jaws
- Specially designed curved handles for more efficient strength application and comfortable rubber handles for firm and safe grip

Sold separately:

KTI57318 - 18" Clipper Cut Bolt Cutter

KTI57330 - 30" Clipper Cut Bolt Cutter

KTI57336 - 36" Clipper Cut Bolt Cutter



Clipper Side Cut



Angled Head Clipper Cut Bolt Cutters

- Angled for easier insertion and keeping work in view
- Heavy duty cutters
- Heat-treated chrome vanadium alloy jaws
- Specially designed curved handles for more efficient strength application and comfortable rubber handles for firm and safe grip

Sold separately:

KTI57414 - 14" Clipper Cut Bolt Cutter

KTI57424 - 24" Clipper Cut Bolt Cutter

KTI57436 - 36" Clipper Cut Bolt Cutter



Clipper Side Cut



KTI57514

14" Wire & Rope Cutter

- Shear-cut blades hold and lock cable in cutting position for a clean, sharp cut
- Chrome-vanadium cutting head
- Designed for cutting wire rope, piano wire, steel wire, ACSR cable and aircraft cable
- 14" overall length
- Lifetime warranty



Specialty Tools

KTI72355

Ratcheting Hose and Pipe Cutter

KTI's ratcheting hose and pipe cutting pliers accommodate a variety of materials up to 1-1/2" in diameter. The ratcheting action makes cutting smooth and easy. A one-touch, quick release lever opens pliers instantly. Built-in clasp securely locks handles when not in use for added safety. Cuts industrial air hose, multipurpose hose, heater and washer vacuum hose, non-metallic fuel line hose, PVC pipe, battery cables and much more. Lifetime warranty.

Replacement parts:

KTI72355-1 - Replacement blade



LIFETIME WARRANTY*



KTI72801

Hacksaw

12" top quality, sturdy hacksaw. Adjustable tensioner. Includes one (1) saw blade.

LIFETIME WARRANTY*



KTI72802

Heavy-duty Hacksaw

Hacksaw features heavy-duty frame, high leverage tensioner and handle with blade storage compartment. Blade can be set vertically or at 45-degree angle.

LIFETIME WARRANTY*



KTI72380

8" Straight Cut Tin Snips

- One piece drop forged construction of high carbon steel
- Cushion handle with smooth, comfortable bows for ease in use and safety
- Designed for cutting straight and wide curves to the left or right
- Cuts up to .61mm cold rolled steel or .41mm stainless steel
- Cutting blades open to approximately 4" wide
- Induction hardened cutting edges 54-58 HRC



KTI75306

Steel Line Stopper Kit

- Universal steel line stopper
- 5/16", 3/8", 1/2", and banjo fittings (10.4mm and 18mm)
- Suitable for clamping and sealing steel lines for all automotive fluids
- Provides an effective seal to steel lines when disconnected
- Prevents fluid loss and contamination of the work area

Universal steel line stopper with 5/16", 3/8", 1/2" and banjo fittings (10.4mm * 18mm). Suitable for clamping and sealing steel lines on braking system, cooling system, fuel line, air conditioning line, etc. Provides an effective seal to steel lines when disconnected. Prevents fluid loss and contamination of the work area.



KTI79100

Heavy-duty Riveter

Features four different nose pieces to secure rivets: 3/32" (2.4 mm), 1/8" (3.2 mm), 5/32" (4.0 mm) and 3/16" (4.8 mm). Includes rivet samples.

LIFETIME WARRANTY*



KTI79110

Super Heavy-duty Riveter

Tool's 17" handles provide the leverage needed to effortlessly secure five different rivets: 1/8" (3.2 mm), 5/32" (4.0 mm), 3/16" (4.8 mm), 7/32" (6.0 mm) and 1/4" (6.4 mm).

LIFETIME WARRANTY*



KT172310
Tube Cutter Mini -
Range 1/8" to 5/8" OD

Cuts 1/8" to 5/8" OD tubing. Compact size for use in confined areas. Features rollers to ease operation.

LIFETIME WARRANTY*



KT172330
Tubing Cutter Heavy-duty

Cuts 1/8" to 1-1/8" OD tubing. Heavy-duty rollers smooth operation.

LIFETIME WARRANTY*



KT172320
Tubing Bender - U.S.-made

Bends 3/16", 1/4", 5/16" and 3/8" diameter tubing. Features aluminum mandrel.



LIFETIME WARRANTY*



KT172345
Tubing Bender
Heavy-duty Pliers

Bends 3/16", 1/4", 5/16" and 3/8" diameter copper and steel tubing without collapsing or kinking.

LIFETIME WARRANTY*



KT172340
Tubing Bender

Bends 1/4", 5/16" and 3/8" OD aluminum, steel and copper tubing.

LIFETIME WARRANTY*



KT170070
4-Piece Pick Set
with Neon Orange Handles

Includes four picks for removing, installing, aligning, probing and piercing. Use to ease removal of O-rings, split pins, seals and bushes and loose parts. Set contains orange-handled straight, 45 degree, 90 degree and hook picks.

Set includes (also available individually):

- KT170071** - Straight Neon Orange Pick
- KT170072** - 45 Degree Neon Orange Pick
- KT170073** - 90 Degree Neon Orange Pick
- KT170074** - Hook Neon Orange Pick



LIFETIME WARRANTY*



KT170075
4-Piece Pick Set
with Neon Green Handles

Includes four picks for removing, installing, aligning, probing and piercing. Use to ease removal of O-rings, split pins, seals and bushes and loose parts. Set contains green-handled straight, 45 degree, 90 degree and hook picks.

Set includes (also available individually):

- KT170076** - Straight Neon Green Pick
- KT170077** - 45 Degree Neon Green Pick
- KT170078** - 90 Degree Neon Green Pick
- KT170079** - Neon Green Hook Pick



LIFETIME WARRANTY*



KT170010
Tapered Scratch Awl

High quality chrome vanadium steel. Ergonomic, contoured handle. Used for scribing, punching holes and lining up panels or holes.

LIFETIME WARRANTY*



KT173400
Number and Letter Stamp Set - Size 3/16"

Combination set includes 3/16" set of numbers and 3/16" set of letters. Includes convenient storage case.

LIFETIME WARRANTY*



KT170550
Sanding Pen

Over 20,000 glass fibers in a pen point reach where normal sand paper cannot. Includes one extra sanding point in rear cap. U.S.-made.

Replacement parts:

- KT170551** - 2-pack refill for sanding pen



Specialty Tools



KT170040 5-Piece Spiral Extractor Set

Aggressive spiral design provides extra grip to remove stubborn broken bolts. Manufactured with high carbon steel for long wear and durability. Sizes range from 1/8"-3/4" and 3 mm-18 mm.

LIFETIME WARRANTY*



KT170045 5-Piece Fluted Extractor Set

Extractors quickly and easily remove broken screws, pipes, bolts and studs. Manufactured with heat-treated chrome-moly steel for long wear and durability. Sizes range from 1/8"-3/8" and 3 mm-9.5 mm.

LIFETIME WARRANTY*



Deluxe Fender Cover

Vinyl-backed foam cover is designed to protect/cover fenders to avoid scratching, marring or damaging vehicle finish. Available in black or red. U.S.-made.

Sold separately:
KT173201 - Black
KT173202 - Red



LIFETIME WARRANTY*

KT170715 Medium Duty Nut Splitter

- Rugged drop forged frame
- Splits rusted or frozen nuts 1/8" to 15/16" across flats
- Parallel action of pusher cracks nuts on one side without damage to bolt threads

Medium Duty Nut Splitter. Splits rusted or frozen nuts 1/8" to 15/16" across flats. Parallel action of pusher cracks nuts on one side without damage to bolt threads. Cutters never touch the bolt. Compound angle design with 360 degree rotating cutter allows use in difficult to reach locations. A few turns of power screw with a 3/4" hand wrench cuts nut for easy removal. Rugged drop forged frame. Length: 6-1/4".



KT170050 Butane Fuel

1.5 fl.oz. (42g) professional-grade butane fuel. Universal filling tip can be used with most refillable butane products. Adapters are not normally required when refilling tanks. Double scrubbed and triple filtered for trouble-free use. Use for pocket torches, lighters, lanterns, table torches and other butane-powered tools.



KT170461 Child Safety Blanket

This blanket made from Kovenex® flame resistant fabric protects infants from heat and flame. The patented fabric is made with inherently flame resistant fibers with no chemical treatment for an infinite shelf life. Soft, durable and light weight. Size 35" x 39". Weight ~7.0 oz./yd2. Machine washable, no bleach.



KT170450 Welding Blanket

A high-tech carbon fiber welding blanket made with the Pavenex® fabric is lightweight, soft and flexible. Provides protection against direct contact with flame, sparks, and weld spatter. Will withstand temperature up to 2200°F without shrinking. Size: 50" x 80". Made in the USA.



KT170440 Torch Shield

Protect surfaces from sparks or open flame from gas torches with this patented Pavenex® carbon fiber shield. Even withstands the extreme heat of acetylene torches. Size: 10" X 18". U.S.-made



CARBON FIBER FEATURES:

- Lightweight, soft and flexible.
- Protection for direct contact with weld spatter.
- Withstands temperatures to 3,000°F, fire- and heat-resistant.
- Reduces the chance of sparks damaging fabric, pitting glass or marring paint.
- Will not scratch any painted surface.
- Can be used in emergencies to smother small fires in a car or anywhere in the shop.

Warning: Avoid contact with flammable liquids. Flammable liquids will ignite when exposed to sparks or flame. Always inspect welding blanket for damage before each use. Avoid sharp edges or other obstructions to prevent damage to blanket. Clean blanket after each use. To clean, shake the blanket and replace in the original bag. DO NOT clean with water or other liquids. Do not use if wet.





KTD77604

Glassmaster Pro-Poly Bagged

The "Genuine" Glass Master Pro Kit comes in a Nylon Mesh with zip closure storage bag. Professional glass and surface cleaner that Cleans Faster, Easier and with Superior Results. Cleans: fingerprints, smudges, smears, fog, smoke film, haze, dust, water spots and more! Great for cars, trucks, SUV's, mini vans, RV's, Boats, home and the work place.

Kit includes: 14" Comfort Grip Handle, 2 Multi-purpose Cleaning Heads, Microfiber Glass Cleaning Bonnet, Multi-purpose Microfiber Cleaning Bonnet and Nylon Mesh Cleaning Bonnet



KTI70816

Digital Disc Brake Caliper 0-6"

Digital display from 0-6" (150 mm). Accuracy to plus/minus .001" (0.1 mm). Stainless steel construction and shockproof. Thumb wheel for accuracy and ease of use. English/metric readout.

LIFETIME WARRANTY*

KTD77621

Mini-Pro Paddle IGRC yellow

Mini-Pro Paddle IGRC yellow



KTD77622

Mini-Pro Paddle GMP Black

Mini-Pro Paddle GMP Black



KTD77601

GlassMaster Pro Kit

The GlassMaster Pro Kit includes the long-handled GlassMaster Pro wand, two interchangeable cleaning heads, three fitted bonnets, plus a bonus stow-and-go storage bag. The patented GlassMaster Pro effortlessly cleans hard-to-reach areas, including windshields, glass doors, dashboards and much more. Great for cars, SUVs, RVs, trucks, minivans, boats, home and office. Spray favorite cleaners directly on GlassMaster Pro, eliminating overspray on dashboards, sensitive electronics, furniture, etc. Wand boasts super-strong I-beam construction and premium grade ABS materials. Thick comfort grip handle. Use one detachable head for wet cleaning / scrubbing. Use second head for drying/polishing. Kit contains nylon bonnet for scrubbing; multipurpose bonnet for cleaning; and microfiber cloth for removing streaks.

GlassMaster Pro Replacement Parts and Accessories:

KTD72004 - GlassMaster Pro Microfiber Bonnets 3-pack

KTD72502 - GlassMaster Pro Microfiber Cloth 2-pack

KTD74003 - GlassMaster Pro Terry Cloth Bonnets 2-pack

KTD74004 - GlassMaster Pro Terry Cloth Bonnets 3-pack

KTD74503 - GlassMaster Pro Multipurpose Cloths 2-pack

KTD76003 - GlassMaster Pro Assorted Bonnets 3-pack

KTD76503 - GlassMaster Pro Assorted Cloths 3-pack

Kit includes:

One (1) nylon bonnet

One (1) microfiber bonnet

One (1) multipurpose bonnet



KTD-72502



KTD-74003



KTD-74503



KTD-76003

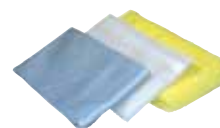

KTD-76503



KTI70900
Magnet Wire Flex
Retriever Tool 8lb. Pull

Retriever goes where human hands cannot. Extendable magnet easily picks up and retrieves dropped items. Tool features an ergonomic grip, a bendable shapeable wire flex shaft, powder-coated steel casings to reduce side pull, and a powerful, lightweight magnet to reach tight places. U.S.-made Length: 21". Pull: 8 lbs.



KTI70901
Magnet Swivel Head
Telescopic Tool 14lb. Pull

Retriever goes where human hands cannot. Extendable magnet easily picks up and retrieves dropped items. Tool features an ergonomic grip, a 180 swivel head, a telescopic shaft, powder-coated steel casings to reduce side pull, and a powerful, lightweight magnet to reach tight places. U.S.-made Length: 6-1/2" to 32". Pull: 14 lbs.



KTI70903
Magnet Telescopic
Tool Straight 14lb. Pull

Retriever goes where human hands cannot. Extendable magnet easily picks up and retrieves dropped items. Tool features an ergonomic grip, a telescopic shaft, powder-coated steel casings to reduce side pull, and a powerful, lightweight magnet to reach tight places. U.S.-made Length: 6-1/2" to 32". Pull: 14 lbs.



KTI70904
Magnet Telescopic
Tool Straight 5lb. Pull

Retriever goes where human hands cannot. Extendable magnet easily picks up and retrieves dropped items. Tool features an ergonomic grip, a telescopic shaft, powder-coated steel casings to reduce side pull, and a powerful, lightweight magnet to reach tight places. U.S.-made Length: 6-1/2" to 32". Pull: 5 lbs.



KTI70905
Magnet Telescoping
Pocket Retriever 3.5lb. Pull

Pocket size retriever features a telescoping shaft that extends from 5-1/4" to 24". Pull: 3-1/2 lbs. U.S.-made



KTI70909
Super-duty
Magnet Telescoping
Tool Straight 30lb. Pull

Super-duty retriever goes where human hands cannot. Extendable magnet easily picks up and retrieves dropped items. Tool features an ergonomic grip, a telescopic shaft, powder-coated steel casings to reduce side pull, and a powerful, lightweight magnet to reach tight places. Length: 16" to 28". Pull: 30 lbs. U.S.-made





KTI70910
Magnetic Pickup Tool

Magnetic telescoping pickup tool extends from 5-1/4" to 22-3/4". Handy pocket-clip keeps the tool right at your fingertips!



KTI70915
Telescoping Pocket Magnet

Extendable magnetic pickup tool extends from 13" to 20". Telescoping shaft is capable of lifting 3.5 pounds. There isn't a lost nut or bolt this tool can't pick up!



KTI70920
Mirror Glass Telescoping Tool Rectangular

Tool goes where human eyes cannot. Highly polished and protected mirror is attached to an expandable telescopic, ergonomic handle for user convenience. Rectangular mirror measures 1-1/4" x 2-1/4". Length: 6-1/2" to 32". U.S.-made



KTI70921
Mirror Glass Telescoping Tool Square

Tool goes where human eyes cannot. Highly polished and protected mirror is attached to an expandable telescopic, ergonomic handle for user convenience. Square mirror measures 1-1/4" x 1-1/4". Length: 6-1/2" to 32". U.S.-made



KTI70922
Mirror Glass Telescoping Tool Round

Tool goes where human eyes cannot. Highly polished and protected mirror is attached to an expandable telescopic, ergonomic handle for user convenience. Round mirror measures 3-3/4". Length: 20" to 31". U.S.-made



KTI70099
Two Way Radio

- 22 channels each with 38 privacy codes
- Up to 18 mile range
- Operating frequency 462.5625 MHz-462.7250 MHz
- Vox/DCM/Monitor/Scan/Squelch
- Roger beep & key tone on/off
- Adjustable volume control
- 5 ringing tones
- Key lock function
- Automatic battery save
- Ear/mic/charger jack
- Belt clip



KTI70999
Magnetic Parts Dish Stainless Steel

Keeps small parts from spilling. Round, non-rusting stainless steel dish measures 5-3/4" diameter.

Specialty Tools

KT175310 2-piece Universal Fuel Line Disconnect Set



2-piece universal fuel line disconnect set is designed to remove stubborn fuel lines from high-tech cars and trucks. Constructed of aircraft-grade aluminum for durability, yet makes them extremely lightweight and easy to use. The low-profile design provides access to the tightest spaces. The opening at the widest point is 3/4" and narrows to only 1/8". Set features a 90-degree fuel line disconnect tool and a straight fuel line disconnect tool.

Set includes (also available individually):

KT175311 - 90 Degree Universal Tool, from 1/8" to 3/4"

KT175312 - Straight Universal Tool, from 1/8" to 3/4"



KT175320 4-Piece Radiator Disconnect Tool Set



4-piece set includes 4 sizes to depress clips ranging from 5/8" to 1". Contains a GM-, Ford-, large- and extra-large radiator disconnect tools. The tool is designed to completely fill the void in the connector to easily release the fastener. Unique 40-degree offset design allows users to work around obstructions in tight spaces.

Set includes (also available individually):

KT175321 - Ford Disconnect Removal Tool

KT175322 - GM Disconnect Removal Tool

KT175323 - Large Disconnect Removal Tool

KT175324 - X-Large Disconnect Removal Tool



KT171103 2-Piece Flexible Line Clamp Set

Squeezes heater, radiator, vacuum or any flexible hose to assist with repairs or problem diagnosis. Clamps lock in place. Set includes one large and one small clamp.



Set includes (also available individually):

KT171105 - small

KT171106 - large



KT170600 Distributor Wrench

Wrench is 3/8" drive and 1/2" x 9/16".



KT171100 Hose Pinch-off Pliers

Eliminates the need to drain coolant when servicing cooling systems. Pliers squeeze shut heater or radiator hoses. Jaws swivel for parallel clamping. Tool features automatic locking ratchet and can also be used with vacuum and fuel lines.



KT171108 Specialty Hose Clamp Plier

This dual purpose plier, with side jaw design allows hose clamps to be applied or removed in confined areas. Pincers are held parallel to the hose.



KT170750 Spark Plug Boot Plier

Plier features insulated grips. Overall length: 8". U.S.-made



KT173701 Universal Spark Plug Gap Tool

Measures in increments of one thousandth from .020 through .100.

KT173701-50 - 50-piece bulk pack





KT172765
Mini Heavy-duty Circuit Tester

Tester is 5" long and includes 2" tempered probe and replaceable bulb. Works on 6 or 12 volt systems. Features 60" heavy-duty flexible wire lead with ground clip.

Replacement parts:

KT172781 - Replacement bulb for models 72765, 72780, 72790, 72791 and 72792



KT172770
Circuit Tester

Tester features 48" extra long leads. Works on 6 or 12 volt systems.

Replacement parts:

KT172771 - Replacement bulb for model 72770



KT172780
Heavy-duty Circuit Tester

Tester features 5' heavy-duty flexible wire, ground clips, tempered probe and replaceable bulb. Works on 6 or 12 volt systems. Spring strain relief on cord.

Replacement parts:

KT172781 - Replacement bulb for models 72765, 72780, 72790, 72791 and 72792



KT172782
Heavy-duty Circuit Tester with 12' Retractable Wire and Clip

Can be used on cars, trucks, SUVs, boats, trailers, vans, RVs, motorcycles, snowmobiles and airplanes. Use the heavy-duty circuit tester to check electrical circuits and accessories on all 6 and 12 volt systems. Tester features a 12' retractable wire and battery clip, spring-supported strain relief, extra-sharp probe and a heavy-duty battery clip.



Extra-long Circuit Testers

Specially designed to enable technicians to test hard to reach circuits that would not be accessible with standard testers. Features extra long, colored, insulated 7-1/2" probe and 60" heavy gauge flexible wire. Works on 6 or 12 volt systems.

Sold separately:

KT172790 - Blue

KT172791 - Red

KT172792 - Yellow

KT172781 - Replacement bulb for models 72765, 72780, 72790, 72791 and 72792



Specialty Tools



KT170720 Serpentine Belt Tool

Removes and installs serpentine belts. Releases tension on serpentine belts with spring loaded idler pulleys requiring a 15, 16 and 18 mm hex or 3/8 inch square drive. Provides extra coverage for most applications.

Set includes (also available individually):

KT170721 - Long Wrench

KT170722 - Short Wrench

KT170723 - 13MM U-Type Wrench

KT170724 - 14MM U-Type Wrench

KT170725 - 15MM U-Type Wrench

KT170726 - 15MM Socket

KT170727 - 16MM Socket

KT170728 - 18MM Socket



KT170730 Stretch Belt Installation Tool

Stretch belt installation tool is ideal for installing newer, patented Gates Micro-V Stretch Fit belts. Stretch belts are found on many models of vehicles with drive systems that do not require a tensioner (i.e. power steering, air conditioning, water pumps). Installs belts without twisting or breaking internal belt fibers. Durable construction features anodized aluminum body for corrosion resistance and a hardened steel pulley pivot.



KT172200 Rotary-style Barrel Pump

Easy-to-operate crank handle rotary pumps are used as a siphon. Simply prime pump by turning crank handle several times: liquid automatically siphons to lower level. Rotary hand pumps fit 15-, 30- and 55-gallon drums. Cast iron rotary pump is ideal for heavy oil, machine oil and non-corrosive liquids. Barrel pump dispenses one gallon per 14 revolutions. Made with a cast iron body with steel inlet and outlet tubing. 2" bung adapter is perfect for drum openings.



Warranty information:
90-day warranty.



KT170732 Tru-Grip Serpentine Belt Tool

Clamping jaw allows user to position serpentine belt without the belt slipping from the tool's grip. Tru-grip and long reach allows belt routing in limited-access areas. Constructed of lightweight alloy steel for durability and strength. Ergonomic handles for comfort and ease of use. Lifetime warranty.



KT170731 European Stretch Belt Installation Tool

Stretch belt installation tool is ideal for installing stretch belts. For use on vehicles with larger pulleys primarily found on European vehicles. Stretch belts are found on many models of vehicles with drive systems that do not require a tensioner (i.e. power steering, air conditioning, water pumps). Installs belts without twisting or breaking internal belt fibers. Durable construction features anodized aluminum body for corrosion resistance and a hardened steel pulley pivot.



KT172205 Lever-style Barrel Pump

Two-piece, self-adjusting telescoping suction tube fits 15-, 30- or 55-gallon drums. Removable threaded spout. Pumps water based fluids, solvents, antifreeze, weak acids and all oil-based fluids. Pumps approximately 300cc liquid per stroke. Zinc plated for lasting quality. Features cushioned vinyl handle.



Warranty information:
90-day warranty.



KTI72250
Siphon Pump

Multi-use pump transfers most liquids. Also pumps air for inflatables. Use for changing oil, siphoning gas, inflating sports balls and beach toys. Includes two 51" siphon hoses, 35" dipstick hose and adapter (for changing oil) and 17" air pressure hose.

Warranty information:
90-day warranty.



KTI74601-1
Long Funnel - Rigid

- Funnel Long Rigid: 4-1/2" Diameter x 19-1/2" Long
- Made in the U.S.A.

KTI74601-12

- Sold as a 12-pack
- Made in the U.S.A.



KTI74602-1
Long Funnel - Flexible

- Flexible 2-piece funnel can be converted to a regular funnel
- Made in the U.S.A.

KTI74602-12

- Sold as a 12-pack
- Made in the U.S.A.



KTI73900
**Air-powered
Piston Grip
Grease Gun**

Portable and nearly effortless to use, gun features rugged heavy-duty steel construction and 50-to-1 pressure ratio. Easily fill with 400cc bulk loading or standard 14 oz. cartridge. Air pressure ranges from 1,200 psi to 6,000 psi (with 30 to 160 psi air supply). Includes rigid and flexible extensions.

Warranty information:
90-day warranty.

KTI74650
**2-Liter Measure Pitcher
with Flex Spout**

- 2-Liter Measure Pitcher
- Flexible Spout
- Translucent



KTI74651
**5-Liter Translucent Measuring
Pitcher with Flexible Spout**

- 5-Liter Measure Pitcher
- Flexible Spout
- Translucent



KTI74605 1-Qt Funnel with Splash Ring and Removeable Flexible Spout

- Removeable flexible spout
- Removeable screen
- Chemically resistant polyethylene

Polyethylene funnel, 1 quart with splash ring, screen and flexible 10-inch removable spout.



KTI74612 3 Quart Drum Funnel with Hinged Lid and 2" Bung

- 3-Quart Drum Funnel with Hinged Lid
- Tough Industrial Quality
- Chemically resistant polyethylene
- Fits 2" thread
- With hinged lid and 2" bung



Funnel Safety Red with Screen

- Safety Red
- Chemically resistant polyethylene
- With screen

KTI74606 - 2 Quart

KTI74610 - 6 Quart



KTI74641 Drip Tray 22" x 22" x 1.5"

- Chemically resistant polyethylene
- Collects drips, leaks, and spills
- Dimensions: 22" x 22" x 1-1/2"
- Made in the U.S.A.



KTI74640 Axle Drain Pan

- Durable and lightweight HDPE plastic with built-in drop proof spouts that help to recycle oil
- Works for most dual and super single wheels, sizes 22.5 and 24.5
- Use with steel and aluminum wheels, hub piloted or stud piloted, drive or trailer axles
- Catches oil, axle nuts, bearings - most anything removed from the wheel end for service
- Attaches with a hand-tightened lug nut

Drain pan works for most dual and super single wheels sizes 22.5 and 24.5. Attaches with a hand-tightened lug nut. Will not tip or spill - virtually eliminating clean up. Works for steel or aluminum wheels, hub piloted or stud piloted, drive or trailer axles. Catches oil, axle nuts, bearings - most anything removed from the wheel end for service. Built in drop proof spouts help to recycle waste oil. Durable and lightweight HDPE plastic. Made in the USA.



Double Cap Funnels

- Double capped funnel keeps the drips in and the dirt out
- This ultimate storage funnel eliminates spills and contaminants, reduces debris and is chemically resistant

KTI74607 1 Pint Double Cap Funnel - Orange

- Top ID: 3" • Spout OD: 1/2"
- Height (without cap): 8.75"



KTI74607



KTI74608



KTI74609



KTI74611



KTI74613

KTI74608 1.25 Quart Double Cap Funnel - Dark Blue

- Top ID: 4" • Spout OD: 3/4"
- Height (without cap): 10.5"

KTI74609 1.3 Quart Double Cap Funnel - Black

- Top ID: 4" • Spout OD: 1.375"
- Height (without cap): 16.5"

KTI74611 1.5 Quart Double Cap Funnel - Yellow

- Top ID: 4" • Spout OD: 3/4"
- Height (without cap): 14.25"

KTI74613 1.66 Quart Double Cap Funnel - Dark Red

- Top ID: 4" • Spout OD: 1.375"
- Height (without cap): 14.25"

KTI74603
Funnel Pivoting
“The Guzzler”

Large capacity funnel directs flow without spilling. Features ball pivot at base. U.S.-made



KTI74604
Funnel for
55-gallon Drum

Large capacity funnel screws directly onto 55 gallon drums. U.S.-made



KTI74630
3-Piece
Funnel Set

KTI's “funnel for every job” set includes 3-1/2”, 5-1/2” and 7-1/2” sizes.



KTI73730
Filter Wrench Nylon Strap

Fits all oil, air and fuel spin-on filters up to 6” diameter. Tool can be turned by a 1/2” square drive ratchet or a 3/4” open end wrench. U.S.-made



KTI73620
Oil Filter Pliers

Self adjusting spring action allows for a full range of filter applications. Heavy-duty forged handles with textured grip for strength and leverage. U.S.-made Use with 2-1/4” - 6” filters.



KTI73731
Heavy-duty Filter Wrench Nylon Strap

Designed for high torque requirements of truck filters, Forged steel handle, and extra length, sturdy strapping. A no-strip strap grips filters tightly. Wrench adapts to spin filters up to 9”.



KTI73621
Truck Oil Filter Pliers

Truck and tractor filter pliers are capable of removing all agricultural and construction equipment and automotive canister-type filters. They are ideal for loosening over-tightened or seized filters, providing superior leverage for high-torque applications. Spring-loaded truck and tractor filter pliers work on auto filters as well as Cummins diesel filters. Range is 4” to 7”. Boasts 17” extended-reach handles which allow users to access the toughest areas. Cushioned, ergonomic handle grips to reduce user fatigue.



Specialty Tools

Adjustable Oil Filter Wrenches

Removes oil filters in hard to reach areas. Tool features a swivel heat treated handle for easy access and durability and a unique yolk and link assembly for positive grip on filter. U.S.-made

KT173601 - Oil Filter Wrench Adjustable from 2-7/8" to 3-1/4"

KT173602 - Oil Filter Wrench Adjustable from 3-7/16" to 3-3/4"

KT173603 - Oil Filter Wrench Adjustable from 4" to 4-3/8"

KT173605 - Oil Filter Wrench for Trucks Adjustable from 4-5/16" to 4-3/4"

KT173606 - Oil Filter Wrench for Trucks Adjustable from 5-1/4" to 5-3/4"



LIFETIME WARRANTY*

KT173600

4-in-1 Oil Filter Wrench

This handy filter wrench boasts a vinyl handle to provide strength and better grip, and swivel movement to clear obstructions. A wide studded band prevents crushed filters. Mechanics who demand a tough and durable product can count on the 4-in-1's stainless, plated and easily interchangeable steel bands. Includes bands sized from 2-3/8"-4-3/8" (61 mm-111 mm).



LIFETIME WARRANTY*

Cap-style Oil Filter Wrenches

Cap style design allows easy removal and installation from the end of the filter, even in tight locations.

KT173613 - Cap Filter Wrench 65mm 14 Flute

KT173614 - Cap Filter Wrench 74-76mm 15 Flute

KT173615 - Cap Filter Wrench 76mm 14 Flute

KT173616 - Cap Filter Wrench 93mm 15 Flute



LIFETIME WARRANTY*

Oil Filter Cap Sockets

Designed to handle a variety of applications, oil filter cap socket is rugged, laser marked and works even in confined areas. Use to remove housings with cartridge-type oil filters.

KT173618 - Oil Filter Cap Socket 32mm

Applications: GM Ecotec 2.2L; Saturn: L-series (2001), Ion and Vue (2002-later); GM: Cavalier, Sunfire, Grand Am, Sonoma, S10, Allero (2002-later), Malibu (2002-2006); Pontiac: G6 and Solstice (2006); Chevrolet: HHR, Cobalt, Cobalt SS (2006); Saab: some models.

KT173619 - Oil Filter Cap Socket 35/36mm

Applications: 6.0L Ford diesel; F250, F350, F450 pickups; Excursion.



LIFETIME WARRANTY*



KTI73607



KTI73608



KTI73609



KTI73623



KTI73624



KTI73625



KTI73610



KTI73613N



KTI73617



KTI73626



KTI73627



KTI73628

Cap Filter Wrenches

Cap style design allows easy removal and installation from the end of the filter, even in tight locations. Use with 3/8" square drive.

KTI73607	Cap Filter Wrench 80mm 15-flute
KTI73608	Cap Filter Wrench 82mm 15-flute
KTI73609	Cap Filter Wrench 86mm 14-flute
KTI73610	Cap Filter Wrench 65/67mm 14-flute
KTI73613N	64/65MM 14 Flute for most Toyota applications
KTI73617	Cap Filter Wrench 76mm 30-flute
KTI73623	Cap Filter Wrench 86mm 16-flute
KTI73624	Cap Filter Wrench 88.4mm 15-flute
KTI73625	Cap Filter Wrench 93mm 36-flute
KTI73626	Cap Filter Wrench 93mm 45-flute
KTI73627	Cap Filter Wrench 96mm 18-flute
KTI73628	Cap Filter Wrench 100mm 15-flute

KTI73611

Cap Filter Wrench, 68 MM, 14 Flutes

- Cap style filter wrench
- 68 mm diameter
- 14 flutes
- Use with 3/8" square drive

Fits: Hastings, Mazda, Ford Escort, Ford Capri, Subaru, Fram filters made in Korea (PH6607) and Motorcraft FL816 filters.



KTI73635

17 Piece Master Oil Filter Wrench Set

- 3/8" drive cap oil filter wrenches.
- Fits 95% of domestic and import automotive applications.
- Complete set comes in a handy 10" x 13" plastic case.
- Kit includes: 80mm 15 flutes, 82mm 15 flutes, 86mm 14 flutes, 65/67mm 14 flutes, 68mm 14 flutes, 73/74mm 14 flutes, 64/65mm 14 flutes, 74/76mm 15 flutes, 76mm 14 flutes, 93mm 15 flutes, 76mm 30 flutes, 86mm 16 flutes, 88.4mm 15 flutes, 93mm 36 flutes, 93mm 45 flutes, 96 mm 18 flutes, 100mm 15 flutes.



KTI73630

Oil Filter Wrench Toyota/Lexus

- Aluminum oil filter wrench
- 64.5mm diameter with 14 flutes
- Use with 3/8" square drive
- Fits Toyota, Lexus, Scion, Honda and Nissan filters



KTI73612

Cap Filter Wrench, 73/74 MM, 14 Flutes

- Cap style filter wrench
- 73/74 mm diameter
- 14 flutes
- Use with 3/8" square drive



Fits 68 mm diameter filters with 14 flutes. Fits filters for Toyota & Lexus.

KTI70082 Hydraulic Flaring Tool Kit

- Hydraulic Flaring Tool Kit
- Comes with molded case



KTI70081 Professional Brake Flaring Tool

This tool will pay for itself with the first project, and it'll give you peace of mind knowing that your brake flares are of OE-precision quality and safety. Mounts in your vise to help you easily form 45-degree double, single and bubble flares in OE steel, stainless steel, and soft metal tubing. Use with 3/16", 1/4", 5/16" and 3/8" diameter lines...which means it will handle all your plumbing jobs from brake lines to transmission cooler lines and fuel lines. Turret-style design allows you to make those precision flares in minimal time. All the brake flaring forming dies you need are mounted right on the turret. T-handle screw clamp holds your line in place during forming.

**LIFETIME
WARRANTY***



KTI70085 ISO Flaring Tool

Kit allows mechanics to create an ISO flare on brake lines without removing them from the vehicle. Although ISO flare is not the standard double flare, it is being installed on domestic and imported front-wheel drive cars and light trucks. Works on mild steel tubing (1.0 mm wall thickness). Kit includes yoke assembly, flaring bar, gauge/wrench and four adapters (4.75 mm, 6 mm, 8 mm and 10 mm). Packaged in blow-molded case. Weight: 2.8 lbs.

**LIFETIME
WARRANTY***





KT170060
Double Flaring Tool

Specially designed for double or single flare in copper, aluminum or soft steel brake line and brass tubing. Includes seven adapters in sizes ranging from 3/16"-5/8". Packaged in blow-molded case. Adapters available individually. Weight: 2.25 lbs.

- KT170060-1 - Wing Nut
- KT170061 - 3/16 Adapter
- KT170062 - 1/4 Adapter
- KT170063 - 5/16 Adapter
- KT170064 - 3/8 Adapter
- KT170065 - 7/16 Adapter
- KT170066 - 1/2 Adapter
- KT170067 - 5/8 Adapter
- KT170068 - Flaring Press
- KT170069 - Sizing Clamp



KT170080
Double Flaring Tool
U.S.-made

Professional double flare tool kit for fabricating double-compression lines (brake lines) or single-compression lines (fuel lines) in copper, steel, or aluminum. Kit features high-grade, alloy-steel center screw; plated, heat-treated, precision-ground swivel; and drop-forged, heat-treated yoke. Includes five adapters (3/16", 1/4", 5/16", 3/8" and 1/2"); each is laser engraved for easy identification. Packaged in blow-molded case. Adapters available individually. Weight: 2.3 lbs.



KT170330
Steering
Wheel Puller U.S.-made

Pulls steering wheels on most common makes of automobiles and light/medium duty trucks. Tool designed to avoid damage to steering shaft threads. Includes five sets of side bolts. U.S.-made.



KT170300
Pulley Puller and
Installer Set

Complete set removes and installs most power steering and alternator pulleys on domestic vehicles. Works with traditional V-shaped pulleys and serpentine belt system pulleys. Packaged in blow-molded case. Weight: 1.85 lbs.



KT170348
Steering Wheel Puller

Puller specially designed to prevent damage to steering shaft threads.



KT170350
Long-jaw
Reversible Puller

Five-ton reversible puller easily removes and installs pressed-on power steering, alternator and air pump pulleys. Includes five-ton reversible puller that can be used as two- or three-jaw puller in eight different combinations.





KT170301
Reversible Puller 3"
2-jaw 2-ton 4" Spread 3-1/4" Reach

Reversible jaws feature a wide face on one end and a narrow face on the other - it's like two tools in one. Grip tightens as pressure is applied. Tool manufactured with heat-treated, drop-forged, alloy steel. Spread: 4". Reach: 3-1/4".

LIFETIME WARRANTY*



KT170302
Reversible Puller 3"
2- or 3-jaw 2-ton
4-3/4" Spread 3-1/2" Reach

Reversible jaws feature a wide face on one end and a narrow face on the other - it's like two tools in one. Grip tightens as pressure is applied. Tool manufactured with heat-treated, drop-forged, alloy steel. Spread: 4-3/4". Reach: 3-1/2".

LIFETIME WARRANTY*



KT170303
Reversible Puller 4"
2-jaw 4-ton
6" Spread 3-1/4" Reach

Reversible jaws feature a wide face on one end and a narrow face on the other - it's like two tools in one. Grip tightens as pressure is applied. Tool manufactured with heat-treated, drop-forged, alloy steel. Spread: 6". Reach: 3-1/4".

LIFETIME WARRANTY*



KT170304
Reversible Puller 4"
2- or 3-jaw 5-ton
7" Spread 3-1/4" Reach

Reversible jaws feature a wide face on one end and a narrow face on the other - it's like two tools in one. Grip tightens as pressure is applied. Tool manufactured with heat-treated, drop-forged, alloy steel. Spread: 7". Reach: 3-1/4".

LIFETIME WARRANTY*



KT170305
Reversible Puller 6"
2-jaw 5-ton
6" Spread 3-1/4" Reach

Reversible jaws feature a wide face on one end and a narrow face on the other - it's like two tools in one. Grip tightens as pressure is applied. Tool manufactured with heat-treated, drop-forged, alloy steel. Spread: 6". Reach: 3-1/4".

LIFETIME WARRANTY*



KT170306
Reversible Puller 6"
2- or 3-jaw 5-ton
6" Spread 3-1/4" Reach

Reversible jaws feature a wide face on one end and a narrow face on the other - it's like two tools in one. Grip tightens as pressure is applied. Tool manufactured with heat-treated, drop-forged, alloy steel. Spread: 6". Reach: 3-1/4".

LIFETIME WARRANTY*



KTi70311
Adjustable Puller 4"
2-jaw 2-ton
4" Spread 3-1/2" Reach

Ideal for light duty gear pulling, such as electric motors and refrigeration applications. Spread: 4". Reach: 3-1/2". Capacity: 2 tons. U.S.-made.



KTi70312
Adjustable Puller 6"
2-jaw 5-ton
6" Spread 3-1/2" Reach

Ideal for most medium duty gear pulling tasks. Designed for maximum utility. Reversible jaws have a wide face on one end and a narrow face on the other. Spread: 6". Reach: 3-1/2". Capacity: 5 tons. U.S.-made.



KTi70313
Adjustable Puller 7"
2-jaw 5-ton
7" Spread 5-1/2" Reach

Ideal for most medium duty gear pulling tasks. Offers a wide range of reach. Spread: 7". Reach: 5-1/2". Capacity: 5 tons. U.S.-made.



KTi70321
Adjustable Puller 4"
3-jaw 2-ton
4" Spread 3-1/2" Reach

Three jaws provide extra stability, making this puller ideal for light duty gear pulling applications. Spread: 4". Reach: 3-1/2". Capacity: 2 tons. U.S.-made.



KTi70322
Reversible Puller 7"
2- or 3-jaw 5-ton
7" Spread 3-1/2" Reach

Tool complete with versatile combination yoke that can be assembled to make either a 2-3 jaw puller. Reversible jaws for internal or external pulls. A 3-point pull provides extra power and stability when needed. Spread: 7". Reach: 3-1/2". Capacity: 5 tons. U.S.-made.



KTi70323
Adjustable Puller 8"
2- or 3-jaw 5-ton
8" Spread 5-1/2" Reach

Tool complete with versatile combination yoke that can be assembled to make either a 2-3 jaw puller. A 3-point pull provides extra power and stability when needed. Spread: 8". Reach: 5-1/2". Capacity: 5 tons. U.S.-made.



Specialty Tools



KT170355 Pilot Bearing Puller

Use to remove fly wheel pilot bearings up to 7-1/2" long in tight spaces where a slide hammer just won't fit. Versatile tool also works as a bearing and bushing puller for generators and starters.
Spread: 1/2" to 1-1/2" I.D. Weight: 2.3 lbs. U.S.-made.



KT170356 Pilot Bearing Slide Hammer

Center rod spreads forged steel jaws, pushing them out against the bearing for quick and easy removal of bearings and other parts located in tight spaces.
Spread: 1/2" to 1-1/2". Weight: 3.7 lbs. U.S.-made.



KT170360 Pitman Arm Puller

Removes full-size Pitman arms from most cars and light trucks. Features drop-forged frame and carbon-steel drive screw.
Opening: 1-5/16" (33 mm). Pull: 2-1/2" (64 mm). Weight: 1.85 lbs.



KT170365 Pitman Arm Puller U.S.-made

Provides steady, smooth pull of a screw-type puller needed when tackling tougher, bigger jobs. Features heat-treated center screw and heat-treated, alloy steel, heavy-duty yoke. Weight: 2.1 lbs. U.S.-made



KT170343 Harmonic Balancer Installer

Easily installs balancers and drive pulleys that are pressed on the crankshaft. Includes eight threaded adapters: 7/16"-20; 1/2"-20; 9/16"-20; 5/8"-20; 3/4"-16; M12-1.5; M14-1.5; and M16-2.0. U.S.-made.



KT170344 Harmonic Balancer Puller

Pulls harmonic balancers on most automobiles. Tool can be used on flywheels, gears, pulleys and other parts with tapped holes. Includes five sets of side bolts. U.S.-made.



**KTI70372
Universal Strut
Spring Compressor**

Serves a wide range of MacPherson struts without the need to use special adapter shoes. Jaws are held in place by safety lock pins. Tool can be driven by hand or with an impact wrench. Compresses springs ranging from 4"-9" O.D. with wire diameters of 7/16"-11/16". Packaged in blow-molded storage case. Weight: 21 lbs.



**LIFETIME
WARRANTY***

**KTI70370
MacPherson Strut
Spring Compressor**

Works with most MacPherson strut assemblies to quickly assist in replacement of bent struts, strut tubes and damaged filters while on or off the vehicle. Tool manufactured with Acme threaded screw for durability. Fits most automobiles, but should not be used on GM "A," "C," "J" or "X" body cars. Weight: 7 lbs.



**LIFETIME
WARRANTY***

**KTI70375
Coil Spring Compressor**

Single action tool boasts strong, steel jaws that securely hook into coil springs for their removal and installation. Works with most domestic and some imported vehicles. Should not be used on MacPherson struts. Weight: 3.5 lbs.



**LIFETIME
WARRANTY***

**KTI70371
MacPherson
Heavy-duty Strut
Spring Compressor**

Works with most MacPherson strut assemblies to quickly assist in replacement of bent struts, strut tubes and damaged filters while on or off the vehicle. Tool manufactured with Acme threaded screw for durability. Fits most automobiles, but should not be used on GM "A," "C," "J" or "X" body cars. Weight: 7 lbs.

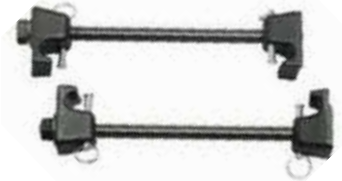

**LIFETIME
WARRANTY***

**KTI70380
Rear Axle Bearing Puller Kit**

Make easy work of removing semifloating rear axle bearings. Set includes three sizes to service most domestic cars. Use with standard slide hammer.



**LIFETIME
WARRANTY***

**KTI70382
Bearing Separator 0 to 4-1/4"**

Removes generator gears, bearing cones, bearings and similar parts that puller jaws cannot reach. Designed to reduce risk of damage to part. Flush knife-edge blades get behind work where most puller jaws cannot fit or grip. Manufactured with high quality, heat treated steel. Spread: 0"-4-1/4". Threaded holes: 5/8"-18".



**LIFETIME
WARRANTY***

**KTI70383
Puller and Bearing
Separator 0 to 2-1/4"**

Removes generator gears, bearing cones, bearings and similar parts that puller jaws cannot reach. Designed to reduce risk of damage to part. Flush knife-edge blades get behind work where most puller jaws cannot fit or grip. Manufactured with high quality, heat treated steel. Spread: 0"-2-1/4". Threaded holes: 3/8"-16".



**LIFETIME
WARRANTY***

**KTI70384
Puller and Bearing
Separator 0 to 4-1/4"**

Removes generator gears, bearing cones, bearings and similar parts that puller jaws cannot reach. Designed to reduce risk of damage to part. Flush knife-edge blades get behind work where most puller jaws cannot fit or grip. Manufactured with high quality, heat treated steel. Spread: 0"-4-1/4". Threaded holes: 5/8"-18".



**LIFETIME
WARRANTY***

Specialty Tools

KTI71556

Ball Joint Service Tool and Master Adapter Set

- For removing and replacing ball joints
- Remove and replace universal joints by using the C-Frame press
- Includes one live center forcing screw, receiver tubes, and removing/installing adapters
- Packaged in a red blow-molded case for storage and carrying

Ball joint service tool and master adapter contains: all new receiver tubes and removing/installing adapters required to work on a press-fit upper and lower ball joints on most Ford, GM, and Dodge 2 and 4 wheel drive pickups, vans and sport utility vehicles through 1997. It all comes in a handy storage/carrying red blow-molded case.



KTI71555

Ball Joint Master Service Adapter Set

Kit includes all receiver tubes and removing/installing adapters needed to work on most GM, Ford and Dodge 2WD and 4WD pick-ups, vans and sport utility vehicles through 1997. Works on press fit upper and lower ball joints. Packaged with application chart.

KTI71550

4-in-1 Ball Joint Service Set

Removes and installs press fit parts, such as ball joints, universal joints and truck anchor pins without makeshift techniques. Takes out even rusted and corroded parts. Includes three receiver tubes (2-3/4" ID x 3" OD, 2-1/4" ID x 2-1/2" OD and 1-3/4" ID x 2" OD).



KTI70500

Heavy-duty 10 lb. Dent Puller Kit

Kit contains 10 lb. slide hammer, two pipes (two-hole and hex nut), and chain with hook and five-plate puller attachments. Packaged in blow-molded case.



KTI70510

Slide Hammer Puller Kit

Easily removes flange-type axles, oil seals, bearings and other press fit parts. Includes: 5 lb. slide hammer; 8-function/3-jaw puller; 2-jaw puller; puller hook; rear axle puller; dent puller; and grip wrench adapter.



KTI71519

Tie Rod End Tool

Inexpensive and effective way to turn smooth tie rod ends. Able to remove the inner tie rod without removing the outer tie rod. Excellent for repairing rack seals. Simply slide the tool over the end and tighten the collar to allow access with a 3/8" drive extension. Fits most inner tie rods. Lifetime warranty.

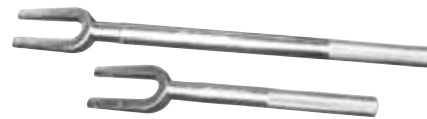

Tie Rod and Ball Joint Separators

KTI71501

Use to replace worn out tie rods and separate shock absorber links. Tine opening: 11/16". Overall length: 15-3/4".

KTI71502

Use to replace worn out ball joints and remove CV drive shafts on FWD vehicles. Tine opening: 15/16". Overall length: 11-3/4".

LIFETIME WARRANTY*

LIFETIME WARRANTY*

KTI75201

Ford Triton Spark Plug Extractor Set

KTI's spark plug extractor set is a must-have for servicing Ford Triton engines model year 2004 and later. This set easily extracts frozen and broken off spark plug sleeves from cylinder heads without removing the actual heads. A specially machined guide works with extra-long tap and extractor to ensure the job is done right. Avoid engine damage by using the KTI spark plug porcelain extractor set (KTI75202) to remove broken porcelain before extracting spark plug sleeve. Lifetime warranty.

LIFETIME WARRANTY*



KTI75202

Ford Porcelain Spark Plug Extractor Set

KTI's spark plug porcelain extractor set works in conjunction with the KTI spark plug extractor set (KTI75201). It is a must-have set for servicing Ford Triton engines model year 2004 and later. This set easily extracts broken porcelain from spark plug sleeves. Set uses a special bonding agent to extract porcelain from spark plug sleeve without pushing on the broken plug and potentially pushing it into the cylinder causing engine damage. Meets Ford TSB specifications. Lifetime warranty.

LIFETIME WARRANTY*



C-clamps

Adjustable C-clamps manufactured from ductile iron.

Sold separately:

KTI70182 - 2"

KTI70183 - 3"

KTI70184 - 4"

KTI70186 - 6"

KTI70188 - 8"

LIFETIME WARRANTY*

KTI70057 Self Igniting Butane Torch Head

- Self igniting butane torch head with piezo igniter for instant flame
- Safety lock feature to prevent accidental ignition
- Ignition button lock for continuous use
- Replacement brass tip
- Ergonomic handle design



Self Igniting Butane Torch Head for use with MAPP or propane gas.

KTI70052

Butane Lighter

- Handy pocket butane torch
- Light duty soldering such as: shrinking heat seal tubing, craft projects, thawing frozen locks, lighting camp stoves



KTI70054

Mini Butane Torch

- Mini butane torch with solder head
- Piezo-electric ignition with locking safety mechanism
- Temperature and flame control, up to 2372 degrees Fahrenheit jet flame
- Removeable safety stand
- Anti-flare



KTI70056

Self Igniting Butane Torch Head

- Portable and lightweight
- Easy on/off valve
- High energy flame
- Angled swivel tube to reach difficult areas



Self Igniting Butane Torch Head for use with MAPP or propane gas.



KT170390 MEGAHAMMER® 3 Piece Set

- Saves time and money while servicing 3/4 and 1 ton Chevrolet and Dodge pickups with Dana axles
- Unique 4-6-8 bolt head will accommodate most trucks
- Removes seized hubs & rotors
- Eliminates damage removing captured rotors
- Cut the job in half

The MEGAHAMMER™ is the ultimate contender for all your tough jobs. A must have tool to service all 4 - wheel drive vehicles with captured rotors. Use it for: Rotor Replacement, Hub and Bearing Work, Axle Service, and Ball joint service.

Over the years rust and corrosion will build up and make removal of a seized bearing assembly almost impossible. Technicians are left with little recourse other than time consuming and labor-intensive measures to attempt to remove the seized bearing assembly. Most methods of removal employed today risk damaging the vehicle which in turn will increase repair costs.

The MEGAHAMMER™ tool's unique, patented design cuts repair time in half by employing a less labor-intensive process and greatly reduces the risks of damaging the vehicle. The size and capabilities of MEGAHAMMER™ make even the most formidable jobs seem easy. Many shops will not provide service to 4-wheel drive vehicles with captured rotors because of the costs and risks involved. With MEGAHAMMER™, your shop can confidently handle all of these tough jobs.

Replacement parts:

- KT170395** - Replacement Slide and Stop Assembly
- KT170396** - Replacement Hammer Assembly

Warranty information:
1-year warranty.



CAUTION: Lock nut on hub removal tool must be tight to protect against thread damage. Slide shaft thread to be engaged into base late thread so it is flush with inside edge of base plate thread. Use countersunk holes ONLY for proper grip on studs. Use outboard support to help prevent tool and wheel assembly from dropping to floor. Do not stand behind tool when in use. Tool is heavy. Use extreme caution when lifting. Keep extremities clear of pinch points. Always wear eye protection when using hub removal tool. Locking pin must be in place when not in use. Not responsible for damage to vehicle.

WARNING: Please follow instructions carefully to reduce risk of personal injury or possible damage to the vehicle.



KT170390KIT MEGAHAMMER® Hub Removal Kit

- Removes seized bearing assemblies and associated components from a vehicle chassis for maintenance and repair
- Minimizes cost and potential damage
- Compatible with 3/4- and 1-ton American made trucks with 4-, 6- or 8-bolt patterns

MEGAHAMMER kit includes 4-, 6-, and 8-bolt head, slide and stop assembly and hammer assembly. 38" length. This kit also contains a 5-bolt head for servicing 1/2-ton Ford, GM and Dodge trucks, 8-bolt head for servicing Ford Super Duty F250/F350 4x4 trucks, and 6-bolt head for use primarily with Dodge Durango and Chevy Trailblazer. It will however, accommodate any 6-bolt patterns with bolt circle diameters from 4" up to 6.75".

Warranty information:
1-year warranty.



KT170391 MEGAHAMMER® 5-bolt Head

Services 1/2-ton Ford, GM and Dodge trucks. 8" diameter, 17-1/2 lbs.

Warranty information: 1-year warranty.



KT170392 MEGAHAMMER® 8-bolt Head

Services Ford Super Duty F250/F350 4x4 trucks. 8" diameter, 28-1/2 lbs.

Warranty information: 1-year warranty.



KT170394 MEGAHAMMER® 4-, 6-, 8-bolt Head

Services 3/4- and 1-ton American made trucks with 4-, 6- or 8-bolt patterns. 8" diameter, 17-1/2 lbs.

Warranty information: 1-year warranty.



KT170393 MEGAHAMMER® 6-bolt Head

For use primarily with Dodge Durango and Chevy Trailblazer. It will, however, accommodate any 6-bolt patterns with bolt circle diameters from 4" up to 6.75".

Warranty information: 1-year warranty.



KT170397 MEGAHAMMER® 4-bolt Head

Primarily for use with Honda vehicles with 4-bolt patterns. It will fit 4-bolt patterns with bolt circle diameters from 4.2" up to 5.26".

Warranty information: 1-year warranty.





Brake, Tire, Wheel and TPMS

Brake, Tire, Wheel and TPMS



KT122802 3-piece Brake Service Torq Socket Set 3/8" Drive

Three-piece set includes T-40, T-45 and T-50 Torq bits. Use on disc brake calipers to remove and install brake pads. Bits are heat treated and precision machined. All are 3/8" drive.

Set includes (also available individually):

- KT122840 - T40 torq socket
- KT122845 - T45 torq socket
- KT122850 - T50 torq socket



KT122902 3-Piece Brake Caliper Hex Bit Set SAE 3/8" Drive

Three-piece set includes 1/4", 5/16", 3/8" hex bits. Use on disc brake calipers to remove and install brake pads. Bits are heat treated and precision machined.

Set includes (also available individually):

- KT122908 - 1/4" hex bit
- KT122910 - 5/16" hex bit
- KT122912 - 3/8" hex bit



KT127902 3-Piece Brake Caliper Hex Bit Set Metric 3/8" Drive

Three-piece metric set includes 7mm, 8 mm, 10 mm hex bits. Use on disc brake calipers to remove and install brake pads. Bits are heat treated and precision machined.

Set includes (also available individually):

- KT127907 - 7mm hex bit
- KT127908 - 8mm hex bit
- KT127910 - 10mm hex bit



KT170163 Disc Brake Piston tool

Rotates pistons back into brake calipers when replacing brake pads on vehicles with rear wheel disc brakes. Provides 6-drive pin configurations to fit most Chrysler, Ford and GM cars and light trucks. 3/8" square drive.



KT171920 7-Piece Wheel Bearing Locknut Set

- 1/2" Drive
- Includes locknut sockets: 55 mm hex; 2-3/8" hex; 2-1/2" hex; 2-1/2" rounded hex; 2-3/4" rounded hex; 2-9/16" rounded hex; and 2-3/8" rounded hex.
- Packaged in blow-molded case.
- Sockets available individually.

Set includes (also available individually):

- KT171921 - 55mm hex
- KT171922 - 2-3/8" hex
- KT171923 - 2-1/2" hex
- KT171924 - 2-1/2" round hex
- KT171925 - 2-3/4" round hex
- KT171926 - 2-9/16" round hex
- KT171927 - 2-3/8" round hex





KTI72261
Automotive Test and Bleed Kit

- Break bleeder and auto tune-up kit
- Allows a single technician to quickly and cleanly bleed automotive brake and hydraulic clutch systems
- Technician can get answers to hundreds of automotive diagnostic and mechanical tests
- Powerful piston-style pump features a one-finger trigger vacuum release patented contoured molded grip and durable, lightweight, non-corrosive PVC construction
- Integrated diaphragm-style gauge displays Hg and kpa units and can be easily read by either right- or left-handed users

Along with the pump, the kit contains all components needed for one-person operation.



KTI71910
Lugnut Removing Set

- Removes locking lug nuts and locking hubcaps on most vehicles.
- For use with impact wrenches.
- Packaged in blow-molded case.

LIFETIME WARRANTY*



KTI71940
4-way Lugnut Wrench Fractional

- Sizes: 11/16", 3/4", 13/16" and 7/8"
- Drop-forged and heat-treated for strength and durability.
- Cross design provides improved leverage and extra torque.

LIFETIME WARRANTY*



KTI71980
4-way Lugnut Wrench Metric

- Sizes: 17mm, 19mm, 21mm and 23mm
- Drop-forged and heat-treated for strength and durability.
- Cross design provides improved leverage and extra torque.

LIFETIME WARRANTY*

Brake, Tire, Wheel and TPMS

KTI33300 7 Piece 1/2" Drive Thin Wall

Protective Socket Set

- Sockets made of chrome moly steel
- Complete set comes in a handy plastic case
- Set includes: 17mm blue color, 19mm gold color, 21mm red color, 13/16" purple color, 7/8" green color, 1" titanium color, 1-1/16" black color



Set includes (also available individually):

KTI33317	Thin Wall Protective Socket	17mm	Blue
KTI33319	Thin Wall Protective Socket	19mm	Gold
KTI33321	Thin Wall Protective Socket	21mm	Red
K T I 3 3 3 2 6	Thin Wall Protective Socket		
K T I 3 3 3 2 8	Thin Wall Protective Socket		
K T I 3 3 3 3 2	Thin Wall Protective Socket		
KTI33334	Thin Wall Protective Socket	1-1/16"	Black

KTI33350 7 Piece 1/2" Drive Torque Extension Set

- For use with thin wall impact sockets.
- Prevent over torque of wheel nuts.
- Use with foreign or domestic cars and light trucks.
- Complete set comes in a handy plastic case.
- 7 Piece Torque Extension Set 1/2" Drive.



Set includes (also available individually):

KTI33351	1/2" Drive Torque Extension	55 ft./lbs.	Red
KTI33352	1/2" Drive Torque Extension	65 ft./lbs.	Yellow
KTI33353	1/2" Drive Torque Extension	80 ft./lbs.	Green
KTI33354	1/2" Drive Torque Extension	100 ft./lbs.	Purple
KTI33355	1/2" Drive Torque Extension	120 ft./lbs.	Green
KTI33356	1/2" Drive Torque Extension	140 ft./lbs.	Titanium
KTI33357	1/2" Drive Torque Extension	175 ft./lbs.	Orange



ACC10-0314 4-Piece AccuTorq® Set Application: Ford

Set includes (also available individually):

ACC10-0308	Gray	1/2" drive	19mm	100 ft./lbs.
ACC10-0310	Light Brown	1/2" drive	21mm	80 ft./lbs.
ACC10-0311	Brown	1/2" drive	21mm	100 ft./lbs.
ACC10-0313	Turquoise	1/2" drive	7/8"	140 ft./lbs.



ACC10-0315 4-piece AccuTorq® Set Application: Cars, Vans and Light Trucks

Set includes (also available individually):

ACC10-0306	Yellow	1/2" drive	19mm	65 ft./lbs.
ACC10-0307	Blue	1/2" drive	19mm	80 ft./lbs.
ACC10-0308	Gray	1/2" drive	19mm	100 ft./lbs.
ACC10-0311	Brown	1/2" drive	21mm	100 ft./lbs.



ACC10-0317 5-Piece AccuTorq® Set

Set includes (also available individually):

ACC10-0305	Red	1/2" drive	17mm	80 ft./lbs.
ACC10-0307	Blue	1/2" drive	19mm	80 ft./lbs.
ACC10-0308	Gray	1/2" drive	19mm	100 ft./lbs.
ACC10-0310	Light Brown	1/2" drive	21mm	80 ft./lbs.
ACC10-0311	Brown	1/2" drive	21mm	100 ft./lbs.



ACC10-0319 9-Piece AccuTorq® Set

Set includes (also available individually):

ACC10-0304	Green	1/2" drive	17mm	55 ft./lbs.
ACC10-0305	Red	1/2" drive	17mm	80 ft./lbs.
ACC10-0306	Yellow	1/2" drive	19mm	65 ft./lbs.
ACC10-0307	Blue	1/2" drive	19mm	80 ft./lbs.
ACC10-0308	Gray	1/2" drive	19mm	100 ft./lbs.
ACC10-0310	Light Brown	1/2" drive	21mm	80 ft./lbs.
ACC10-0311	Brown	1/2" drive	21mm	100 ft./lbs.
ACC10-0312	White	1/2" drive	22mm	120 ft./lbs.
ACC10-0313	Turquoise	1/2" drive	7/8"	140 ft./lbs.



ACC10-0321
8-Piece

AccuTorq® Set

Set includes (also available individually):

ACC10-0304	Green	1/2" drive	17mm	55 ft./lbs.
ACC10-0305	Red	1/2" drive	17mm	80 ft./lbs.
ACC10-0306	Yellow	1/2" drive	19mm	65 ft./lbs.
ACC10-0307	Blue	1/2" drive	19mm	80 ft./lbs.
ACC10-0308	Gray	1/2" drive	19mm	100 ft./lbs.
ACC10-0310	Light Brown	1/2" drive	21mm	80 ft./lbs.
ACC10-0311	Brown	1/2" drive	21mm	100 ft./lbs.
ACC10-0313	Turquoise	1/2" drive	7/8"	140 ft./lbs.



ACC10-0322
10-Piece

AccuTorq® Set

Set includes (also available individually):

ACC10-0304	Green	1/2" drive	17mm	55 ft./lbs.
ACC10-0305	Red	1/2" drive	17mm	80 ft./lbs.
ACC10-0306	Yellow	1/2" drive	19mm	65 ft./lbs.
ACC10-0307	Blue	1/2" drive	19mm	80 ft./lbs.
ACC10-0308	Gray	1/2" drive	19mm	100 ft./lbs.
ACC10-0310	Light Brown	1/2" drive	21mm	80 ft./lbs.
ACC10-0311	Brown	1/2" drive	21mm	100 ft./lbs.
ACC10-0312	White	1/2" drive	22mm	120 ft./lbs.
ACC10-0313	Turquoise	1/2" drive	7/8"	140 ft./lbs.
ACC10-3899	Light Green	1/2" drive	24mm	140 ft./lbs.



ACC10-0324
5-Piece

AccuTorq® Set
Application: Ford

Set includes (also available individually):

ACC10-0308	Gray	1/2" drive	19mm	100 ft./lbs.
ACC10-0310	Light Brown	1/2" drive	21mm	80 ft./lbs.
ACC10-0311	Brown	1/2" drive	21mm	100 ft./lbs.
ACC10-0313	Turquoise	1/2" drive	7/8"	140 ft./lbs.
ACC10-0328	Charcoal	1/2" drive	21mm	147 ft./lbs.



ACC10-0326
6-Piece

AccuTorq® Set
Application: Ford

Set includes (also available individually):

ACC10-0308	Gray	1/2" drive	19mm	100 ft./lbs.
ACC10-0310	Light Brown	1/2" drive	21mm	80 ft./lbs.
ACC10-0311	Brown	1/2" drive	21mm	100 ft./lbs.
ACC10-0313	Turquoise	1/2" drive	7/8"	140 ft./lbs.
ACC10-0328	Charcoal	1/2" drive	21mm	147 ft./lbs.
ACC10-3898	Light Purple	1/2" drive	22mm	160 ft./lbs.



ACC10-0323
10-Piece

AccuTorq® Set

Set includes (also available individually):

ACC10-0327	Light Blue	1/2" drive	22mm	100 ft./lbs.
ACC10-0328	Charcoal	1/2" drive	21mm	147 ft./lbs.
ACC10-0329	Off White	1/2" drive	17mm	90 ft./lbs.
ACC10-0334	Light Yellow	1/2" drive	17mm	113 ft./lbs.
ACC10-0336	Orange	1/2" drive	22mm	75 ft./lbs.
ACC10-0340	Mud	1/2" drive	14mm	80 ft./lbs.
ACC10-0341	Quartz	1/2" drive	19mm	120 ft./lbs.
ACC10-0342	Light Tan	1/2" drive	19mm	90 ft./lbs.
ACC10-0343	Red Orange	1/2" drive	21mm	110 ft./lbs.
ACC10-3898	Light Purple	1/2" drive	22mm	160 ft./lbs.



Brake, Tire, Wheel and TPMS



ACC10-0450

**4-Piece
AccuTorq® Set
Application: Deep Well Truck**

Set includes (also available individually):

ACC10-0312	White	1/2" drive	22mm	120 ft./lbs.
ACC10-0313	Turquoise	1/2" drive	7/8"	140 ft./lbs.
ACC10-0328	Charcoal	1/2" drive	21mm	147 ft./lbs.
ACC10-3899	Light Green	1/2" drive	24mm	140 ft./lbs.

LIFETIME WARRANTY*



**ACC10-0455
5-Piece
AccuTorq® Set
Application: Light Truck**

Set includes (also available individually):

ACC10-0312	White	1/2" drive	22mm	120 ft./lbs.
ACC10-0313	Turquoise	1/2" drive	7/8"	140 ft./lbs.
ACC10-0328	Charcoal	1/2" drive	21mm	147 ft./lbs.
ACC10-3898	Light Purple	1/2" drive	22mm	160 ft./lbs.
ACC10-3899	Light Green	1/2" drive	24mm	140 ft./lbs.

LIFETIME WARRANTY*



**ACC20-4100
4-Piece Heavy-duty
AccuTorq® Set
3/4" Drive**



Set includes (also available individually):

ACC20-3918	Red	3/4" drive	1-1/4"	250 ft./lbs.
ACC20-3919	Brown	3/4" drive	33mm	475 ft./lbs.
ACC20-3920	Black	3/4" drive	1-1/2"	475 ft./lbs.
ACC20-3921	Yellow	3/4" drive	13/16"	475 ft./lbs.

LIFETIME WARRANTY*



**ACC20-4000
4-Piece Heavy-duty
AccuTorq® Set
1" Drive**



Set includes (also available individually):

ACC20-3908	Red	1" drive	1-1/4"	250 ft./lbs.
ACC20-3909	Brown	1" drive	33mm	475 ft./lbs.
ACC20-3910	Black	1" drive	1-1/2"	475 ft./lbs.
ACC20-3911	Yellow	1" drive	13/16"	475 ft./lbs.

LIFETIME WARRANTY*

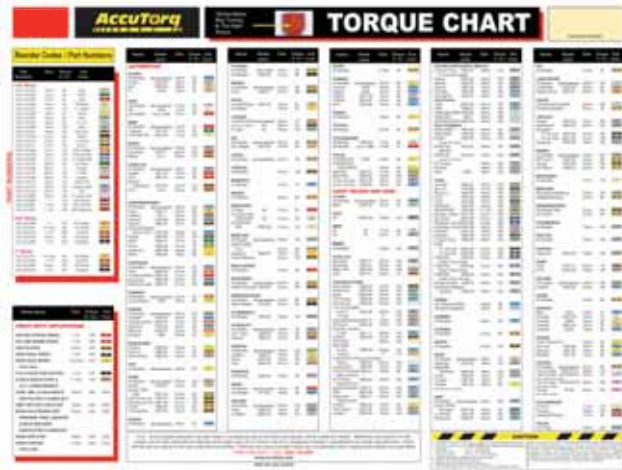

**ACC10-0103
Torque Chart**

Easy-to-read, color-coded torque chart. Lists applications for most foreign and domestic vehicles.



**ACC20-3100
4-Slot Heavy-Duty Storage Bracket**

Heavy-duty wall bracket for convenient storage of heavy-duty torque sockets

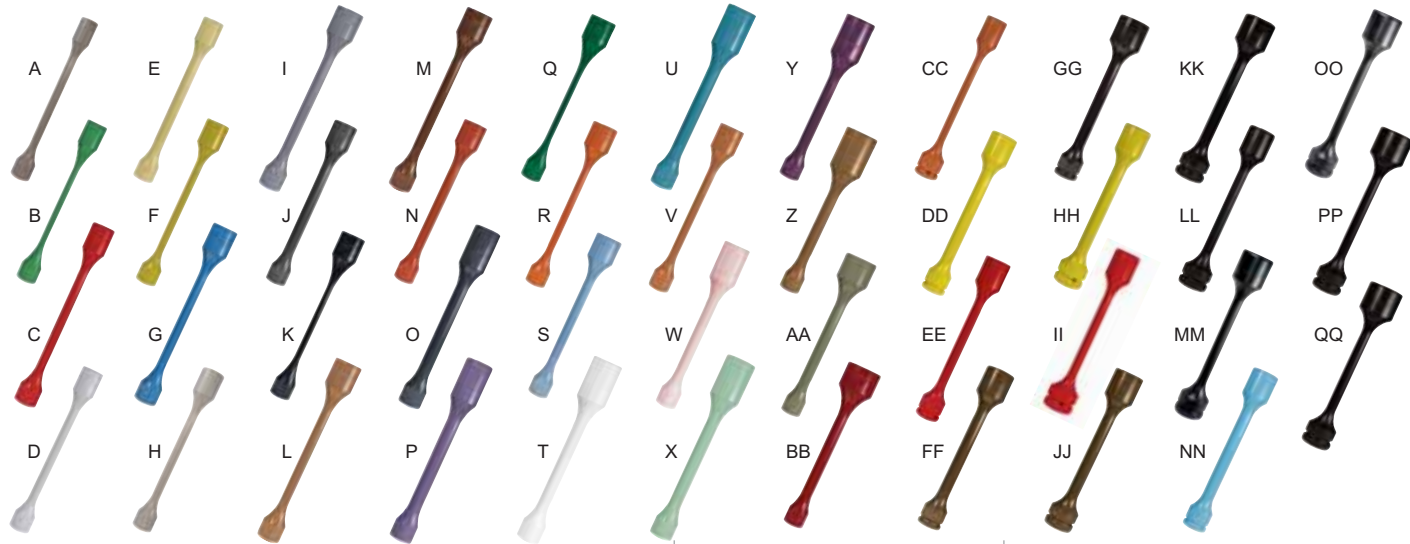

1/2" Drive

3/4" Drive

1" Drive

- ACC10-0340**
14mm - 80 ft/lbs.
Mud (A)
- ACC10-0304**
17mm - 55 ft/lbs.
Green (B)
- ACC10-0305**
17mm - 80 ft/lbs.
Red (C)
- ACC10-0329**
17mm - 90 ft/lbs.
Off White (D)
- ACC10-0334**
17mm - 113 ft/lbs.
Light Yellow (E)
- ACC10-0306**
19mm - 65 ft/lbs.
Yellow (F)
- ACC10-0307**
19mm - 80 ft/lbs.
Blue (G)
- ACC10-0342**
19mm - 90 ft/lbs.
Light Tan (H)
- ACC10-0308**
19mm - 100 ft/lbs.
Gray (I)
- ACC10-0335**
19mm - 110 ft/lbs. - Deep Well
Luminous Red
- ACC10-0341**
19mm - 120 ft/lbs.
Quartz Gray (J)
- ACC10-0309**
21mm - 60 ft/lbs.
Black (K)
- ACC10-0310**
21mm - 80 ft/lbs.
Light Brown (L)
- ACC10-0311**
21mm - 100 ft/lbs.
Brown (M)
- ACC10-0343**
21mm - 110 ft/lbs.
Red Orange (N)

- ACC10-0328**
21mm - 148 ft/lbs.
Charcoal (O)
- ACC10-3898**
21mm - 160 ft/lbs.
Light Purple (P)
- ACC10-0337**
22mm - 60 ft/lbs.
Dark Green (Q)
- ACC10-0336**
22mm - 75 ft/lbs.
Orange (R)
- ACC10-0327**
22mm - 100 ft/lbs.
Light Blue (S)
- ACC10-0312**
22mm - 120 ft/lbs.
White (T)
- ACC10-0313**
22mm - 140 ft/lbs.
Turquoise (U)
- ACC10-0338**
22mm - 110 ft/lbs.
Copper (V)
- ACC10-0339**
22mm - 154 ft/lbs.
Pink (W)
- ACC10-3899**
24mm - 140 ft/lbs.
Light Green (X)
- ACC20-3900**
1" - 140 ft/lbs. (Medium-duty)
Purple (Y)
- ACC20-3901**
1-1/16" - 140 ft/lbs. (Medium-duty)
Tan (Z)
- ACC20-3902**
1-1/8" - 140 ft/lbs. (Medium-duty)
Olive (AA)
- ACC20-3903**
1-1/4" - 140 ft/lbs. (Medium-duty)
Burgundy (BB)

- ACC20-3904**
1" - 175 ft/lbs. (Heavy-duty)
Orange (CC)
- ACC20-3921**
13/16" sq. - 475 ft/lbs. (Heavy-duty)
Yellow (DD)
- ACC20-3918**
1-1/4" - 250 ft/lbs. (Heavy-duty)
Red (EE)
- ACC20-3919**
33mm - 475 ft/lbs. (Heavy-duty)
Brown (FF)
- ACC20-3920**
1-1/2" - 475 ft/lbs. (Heavy-duty)
Black (GG)

- ACC20-3911**
13/16" sq. - 475 ft/lbs. (Heavy-duty)
Yellow (HH)
- ACC20-3908**
1-1/4" - 250 ft/lbs. (Heavy-duty)
Red (II)
- ACC20-3909**
33mm - 475 ft/lbs. (Heavy-duty)
Brown (JJ)
- ACC20-3910**
1-1/2" - 475 ft/lbs. (Heavy-duty)
Black (KK)
- ACC20-3045**
30mm - 330 ft/lbs. (Heavy-duty)
Unpainted (LL)
- ACC20-3056**
30mm - 400 ft/lbs. (Heavy-duty)
Light Blue (NN)
- ACC20-3345**
33mm - 330 ft/lbs. (Heavy-duty)
Unpainted (OO)
- ACC20-3360**
33mm - 440 ft/lbs. (Heavy-duty)
Unpainted (PP)
- ACC20-3913**
33mm - 550 ft/lbs. (Heavy-duty)
Greyline
- ACC20-3914**
33mm - 550 ft/lbs. (Heavy-duty)
Extended Depth
Greyline
- ACC20-4155**
41mm - 400 ft/lbs. (Heavy-duty)
Unpainted (QQ)



ACC2597Y1290
Empty Heavy Duty Case



AccuTorq® Torque

Limiting Sockets

Made of specially heat treated Swedish spring steel, making AccuTorq® the most accurate torque socket in the world. Patented AccuTorq® strobe marks stop turning at precisely the correct torque EVERY time. There is NO guess work and no recalibration. Solid one-piece construction of AccuTorq® automotive and commercial truck sockets eliminates the wide torque variances unavoidable with socket extensions and adapters. Features deep well sockets for those special applications where regular socket depth is just not enough. AccuTorq®'s ultrasonic inspection of EACH socket and its ISO 9001 quality certification of manufacturing processes, make it possible for each AccuTorq to come with a lifetime guarantee. Made in Sweden

Brake, Tire, Wheel and TPMS

Ratcheting-style Torque Wrenches

Ratcheting style torque wrench "clicks" when proper torque is achieved.
Accuracy: $\pm 4\%$. Packaged in blow-molded case.

KTI72117	30-150 in./lbs.	1/4" drive	7-3/4" length
KTI72100	20-200 in./lbs.	3/8" drive	11" length
KTI72101	10-150 ft./lbs.	1/2" drive	18" length
KTI72102	25-250 ft./lbs.	1/2" drive	25" length
KTI72175	100-600 ft./lbs.	3/4" drive	42" length

Warranty information:
90-day limited warranty. Repairable item.
Half-price replacement option after 90-days.



Micrometer-style Adjustable Torque Wrenches U.S.-made

Fast, accurate and easy to use torque wrench features color-coded English and metric settings. Reversible ratchet head for torquing left or right handed fasteners. Ball bearing mounted internal torque mechanism for accuracy and prolonged calibration life.
Accuracy: $\pm 4\%$ within upper 80% of range. Packaged in blow-molded case. U.S.-made.

KTI72118	20-100 in./lbs.	1/4" drive	8-3/4" length
KTI72120	25-250 in./lbs.	3/8" drive	13" length
KTI72121	10-100 ft./lbs.	3/8" drive	17" length
KTI72125	20-150 ft./lbs.	1/2" drive	20-1/2" length
KTI72126	25-250 ft./lbs.	1/2" drive	23" length
KTI72176	100-600 ft./lbs.	3/4" drive	41" length

Warranty information:
1-year warranty. Repairable item.



Micrometer-style Adjustable Torque Wrenches

Achieve the proper torque with KTI's click-style torque wrenches. Torque wrenches are extremely accurate and easy-to-use. Simply adjust the torque specification on the wrench by releasing the red knob and turning the handle of the torque wrench while holding the shaft of the torque wrench. Torque wrenches feature a ball detent socket retainer with push-button release for quick socket changes. Manufactured for accuracy, strength and reliability.
Accuracy: $\pm 4\sim 6\%$. Packaged in a blow-molded case.

KTI72140	25-250 in./lbs.	3/8" drive	8-3/4" length
KTI72143	10-100 ft./lbs.	3/8" drive	16-1/4" length
KTI72141	30-150 ft./lbs.	1/2" drive	18-3/4" length
KTI72142	25-250 ft./lbs.	1/2" drive	21-1/2" length
KTI72145	100-600 ft./lbs.	3/4" drive	39" length

Warranty information:
90-day limited warranty. Repairable item.
Half-price replacement option after 90-days.

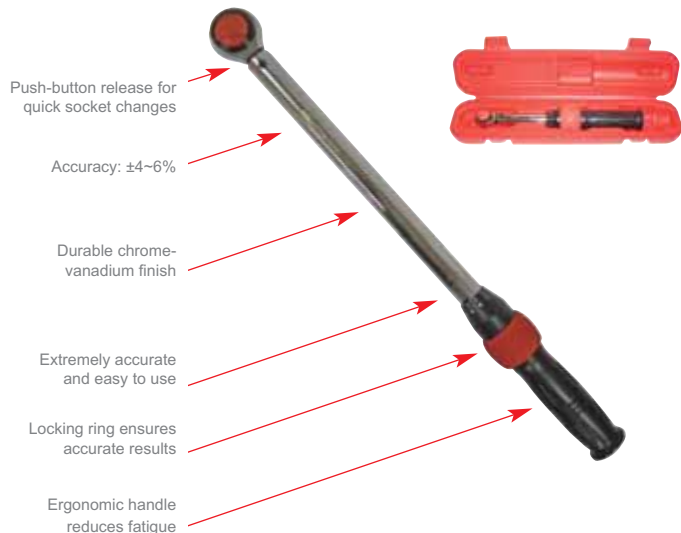

Digital Torque Wrenches

Digital torque wrench eliminates the possibility of human error with a series of lights and alarms that immediately alert the user to torque readings that are "over or under" entered values. Easy to use, exceedingly accurate (plus/minus 1 percent CW, plus/minus 2 percent CCW) and featuring a high contrast, backlit LCD screen display, users press only four buttons to operate the tool: power on/off; unit of measurement (ft./lbs., in./lbs., N-m); torque target up; and torque target down. Technicians can quickly switch among three types of measurement, eliminating the need to have three separate tools. The wrench boasts a non-slip grip, a rugged, durable housing, a 36-tooth gear and a lever-type ratchet to ease directional switching. Estimated battery life: 110 hours. Blow-molded case.

KT172130	10-100 ft./lbs.	3/8" drive	16-1/4" length
KT172133	14.8-73.8 ft./lbs.	3/8" drive	15" length
KT172132	20-250 ft./lbs.	1/2" drive	25" length
KT172134	29.5-147.5 ft./lbs.	1/2" drive	15" length
KT172135	25-250 ft./lbs.	1/2" drive	22" length

Warranty information:

1-year warranty. Repair or replace at discretion of repair center.



KT172138

Digital Torque Adaptor 1/2" Drive

- Use digital torque adaptor with 1/2" drive ratchet
- Static torque measurement
- Three standard functions: torque setting, measurement setting and mode setting
- Operates in clockwise and counter-clockwise directions
- Torque range is 29.5 - 147.5 ft-lbs



Digital torque adaptor turns a regular ratchet into a digital ratchet. Use with 1/2" square drive ratchet. Torque range is 29.5 - 147.5 ft-lbs. Operates in clockwise and counter-clockwise directions. Three standard functions: torque setting, measurement setting, and mode setting.

KT189001

Digital Tire Inflator Gauge

KTI's digital air inflator features a rugged die-cast body and a range of 2 to 150 psi with 0.1 psi resolution. It is programmed to work with various units of measurement (psi/bar/kpa/kg/cm²) and works on TPMS equipped wheels. Features include a large face LCD digital display, anti-oil rubber casting and ergonomic grip. Boasts a dual head chuck and is accurate to within $\pm 1\% + 0.5\text{psi}$ at 100psi and $\pm 2\% + 0.5\text{psi}$ at 150psi. Backlit monitor is powered by two replaceable 3V lithium batteries.

Warranty information:

1-year warranty. Repair or replace at discretion of repair center.



Tire Inflator Gauge with Dual-head Chuck

Tire inflator gauge features pressure range from 10 to 120 lbs. shown in 2 lb. increments, 15" air hose with 1/4" female NPT, 6" chrome-plated dual-head chuck and 3/8" - 24 thread air inlet. Inflator gauge boasts a weatherproof aluminum body with corrosion-resistant brass valve. Rugged construction to withstand everyday use and abuse. Two steel washers provide an air-tight seal. Gauge and valve cartridges are replaceable. Easy-to-read and easy-to-use, magnifying bubble lens allows full view of scale. Angled tip makes it easy to inflate tires on trucks with dual wheels.

KT189002 - Packaged in color box

KT189003 - Packaged in color slip card

Warranty information:

1-year warranty. Repair or replace at discretion of repair center.



Brake, Tire, Wheel and TPMS

KTI71930 45-piece Tire Repair Kit

Easily and quickly repair punctures in tubeless tires. Simply prepare the hole with the spiral reamer, load the plug into the insertion needles, and plug the hole. Components designed for professional use in rugged shop environments. Kit includes handy carrying case and can be used to repair tires on cars, trucks, RVs, motor homes and more. Includes: 2 Allen wrenches; 1 steel insertion needle; 1 steel spiral reamer; 1 50-pack 4" tire string plugs; 1 tub of tire plug lube; 1 blow-molded carrying case.

KTI71931 - Replacement Steel Plunger
KTI71932 - Replacement Steel Reamer

KTI71933 - Replacement 4" Strip 50-pack
KTI71934 - Replacement Tire Plug Lube



KTI71999 Master TPMS Kit

The Master TPMS Kit is the most complete TPMS shop solution available and includes the only sensor activation tool you need! In addition to the TPMS sensor activation tool, the Master TPMS Kit includes the Programming Interface Module (with one year of updates), tool holster, "Guide to TPMS" Training DVD, Quick Reference Guide on CD, TPMS Quick Spec Flip Chart, valve core torque tool and TPMS Four-way valve tool. Also includes Service Procedure Poster, an easy to read step-by-step guide for servicing vehicles with Tire Pressure Monitoring Systems (TPMS).



KTI71990A Sensor Activation Tool with Quick Reference Guide on CD-ROM and Quick Spec Flip Chart

The PST is the only patented universal triggering tool you need for testing and resetting the TPM system. The PST eliminates the need for multiple tools to service various makes and models of vehicles. The TPMS Quick Reference Guide is a comprehensive listing of today's TPM systems, reset procedures and sensor learn procedures. The guide includes a quick reference table designed to provide a single point of reference for determining when TPM systems require re-setting as well as sensor nut torque requirements. The laminated TPMS Quick Spec Flip Chart is designed for the shop environment, and provides a quick but comprehensive snapshot of today's TPM systems.

Warranty information for KTIp.st, PIM and TPMS Scan Tool:

1-year warranty. Repair or replace at the discretion of the repair center. Consumable items are not covered.



**KTI71991
Programming
Interface Module**

The Programming Interface Module (PIM) provides the critical link to update your PST or TIPS tool. One cable connects to a USB port on your computer and the other to a mini-USB located within the battery compartment of the tool. The PIM is a required accessory, allowing you to download updates to your TPM tool. Each PIM is shipped with a software license valid for one TPM tool for one year from date of purchase. TPM tool must be registered to receive software updates.

Warranty information: 1-year warranty.



**KTI71989
Essential TPMS
Combination Kit**

Everything you need in one handy, economical kit. Each kit contains TPM tool, Programming Interface Module (PIM) with one year of updates, Quick Reference Guide on CD, TPMS Quick Spec Flip Chart and the "Guide to TPMS" Training DVD.

Warranty information for KTIpst, PIM and TPMS Scan Tool:

1-year warranty. Repair or replace at the discretion of the repair center. Consumable items are not covered.



**KTI71993
KTIpst Instructional DVD**

The "Guide to TPMS" DVD provides an excellent overview of Tire Pressure Monitoring Systems (TPMS,) as well as step-by-step instructions on how to use PST tool without the marketing hype.



**KTI71992
Heavy-duty Holster for KTIpst**

The holster provides the perfect blend of utility and protection for your TPM tool. Its unique design allows you to operate your tool without having to remove it from the holster. However if you prefer it can be easily removed. The holster clips comfortably to your belt, features elastic pockets for easy storage of your accessory tools (tire pressure gauge, tire crayon, tire tread depth gauge, etc.), and is made of a durable fabric that provides protection from drops and spills.

Brake, Tire, Wheel and TPMS

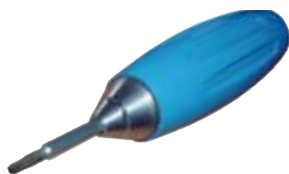

KT171981 TPMS T-10 Torque Limited Screwdriver

KT1's T-10 Torque Tool is used to tighten the torx screw in Schrader snap-in TPMS sensors. These sensors were introduced beginning in the 2007 model year. The torx screw secures the rubber valve stem to the sensor body. The T-10 is preset to 12 in./lbs. (1.3Nm). The T-10 is also used to remove the torx screws.

Replacement parts:

KT118810 - T-10 Replacement Bit



KT171982 TPMS T-20 Torque Limited Screwdriver

KT1's T-20 Torque Tool is used to tighten the torx screw in Beru and other similar TPMS sensors. The torx screw secures the valve stem to the sensor body. The T-20 is preset to 35 in./lbs. (4.0Nm) so the torx screw cannot be over-tightened which may lead to sensor damage and/or incorrect operation. The T-20 is also used to remove the torx screws.

Replacement parts:

KT118820 - T-20 Replacement Bit



KT171996 TPMS Valve Core Torque Tool

Vehicle manufacturers recommend replacing TPMS electroless, nickel-plated valve cores whenever a tire with TPMS is serviced. KT1's Valve Core Torque Tool (part number is a durable, precision torque tool that can be used to remove and install TR C1 valve cores. It safely tightens valve cores to meet manufacturer's requirements for proper torque requirements.



KT171997 TPMS Valve Nut Tool

Vehicle manufacturers recommend replacing TPMS sensor nuts and grommets whenever a tire with TPMS is serviced. KT1's TPMS four-way valve tool (part number KT171997) is a durable, all-in-one tool used for removing the sensor nuts and seating the sensor grommets. This ergonomically designed tool quickly removes both 11 mm and 12 mm nuts, and easily seats both beveled and non-beveled grommets.





Lighting

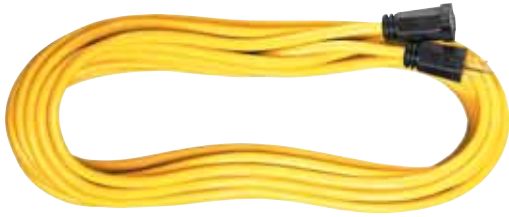

Standard-duty Extension Cords

Standard outdoor extension cord features 16/3 SJTW single tap yellow cord. Medium-duty capacity. Flexible to -40°F. Water and weather resistant. UL listed. Watt: 1625. Amp: 13. Volt: 125.

- KTI73342** - 25' extension cord
- KTI73343** - 50' extension cord



Heavy-duty Extension Cords

Heavy duty extension cord features 14/3 SJTW single tap orange/black cord. LED mounted in end of cord lights up when cord is plugged into 110V power. Watt: 1875. Amp: 15.

- KTI73345** - 25' extension cord
- KTI73346** - 50' extension cord



All-Weather Extension Cords

All-weather extension cord features 16/3 SJEOW single tap blue cord. LED mounted in end of cord lights up when cord is plugged into 110V power. Cord stays flexible even in extreme temperatures (-58°F to 221°F). 16/3 cord. Watt: 1625. Amp: 13.

- KTI73380** - 25' extension cord
- KTI73381** - 50' extension cord



KTI73348 Extra-heavy-duty Extension Cord

Extra-heavy-duty extension cord features 12/3 SJTW single tap orange/black cord. LED mounted in end of cord lights up when cord is plugged into 110V power. Length: 50'. Watt: 1875. Amp: 15.

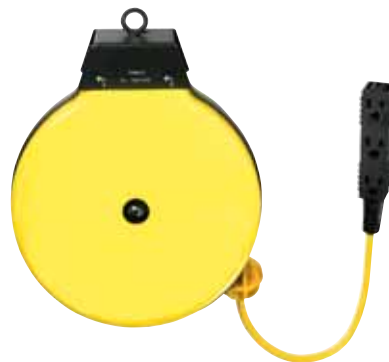

KTI73340 Retractable Extension Cord Reel 30'

Extension reel features oil and water resistant cord, retractable reel, metal housing and circuit breaker protection. Length: 30'. Cord: 16/3 SJT tri-tap. Amp: 10. Watt: 1250.



KTI73341 Retractable Extension Cord Reel 50'

Extension reel features oil and water resistant cord, retractable reel, power indicator, lighted end and circuit breaker protection. Length: 50'. Cord: 16/3 SJEOW tri-tap. Amp: 13. Watt: 1625.

Warranty information

KTI Electrical:

1-year limited warranty. Bulbs are not covered.



KT173358
Trouble Light 25'
Metal Cage Standard Duty

Incandescent trouble lights are ideal for workshops or garages. Heavy duty metal cage features 360 degree rotating hanging hook for maximum flexibility. Switch and outlet in handle.

Length: 25'
 Cord: 18/3 SJT
 Watt: 1250
 Amp: 10



KT173359
Trouble Light 50'
Metal Cage Standard Duty

Incandescent trouble lights are ideal for workshops or garages. Heavy duty metal cage features 360 rotating hanging hook for maximum flexibility. Switch and outlet in handle.

Length: 50'
 Cord: 18/3 SJT
 Watt: 1250
 Amp: 10



KT173360
Trouble Light 25'
Metal Cage Heavy Duty

Incandescent trouble lights are ideal for workshops or garages. Heavy-duty metal cage features 360 degree rotating hanging hook for maximum flexibility. Switch and outlet in handle.

Length: 25'
 Cord: 16/3 SJT
 Watt: 1625
 Amp: 13.



KT173362
Trouble Light 50'
Metal Cage Heavy Duty

Incandescent trouble lights are ideal for workshops or garages. Heavy-duty metal cage features 360 rotating hanging hook for maximum flexibility. Switch and outlet in handle.

Length: 50'
 Cord: 16/3 SJT
 Watt: 1625
 Amp: 13



KT173363
Trouble Light 25'
Metal Cage Industrial Duty

Incandescent trouble lights are ideal for workshops or garages. Heavy-duty industrial cage features 360 degree rotating hanging hook for maximum flexibility. Switch and outlet in handle.

Length: 25'
 Cord: 14/3 SJT
 Watt: 1875
 Amp: 15



KT173379
30 LED SMD Retrofit Light

- Trouble Light 30 LED SMD Retrofit.
- Twist on module converts an incandescent trouble light into a LED
- 30 high powered SMD LED (300 lumens).
- A rubber bumper protects the unit.
- Folding hanging hook fits into the head.

KTI73330

Trouble Light on Reel

Incandescent trouble lights are ideal for workshop or garage environments. Heavy duty metal shades have 360° rotating hanging hooks provide flexibility for all applications. Work lights feature circuit breaker protection and grounded outlet in handle.

Length: 35'
Cord: 16/3 SJT
Metal cage



KTI73335

Industrial Trouble Light on Reel

Incandescent trouble lights are ideal for workshop or garage environments. Heavy duty metal shades have 360 rotating hanging hooks provide flexibility for all applications. Work lights feature circuit breaker protection and grounded outlet in handle.

Length: 50'
Cord: 14/3 SJT
Dual industrial cage.



KTI73315

Fluorescent Angle Light on Reel 35'

13 Watt 16/3

Fluorescent work lights are cool to the touch and energy efficient. All fluorescent lights are UL and cUL approved. All angle lights have 360 degree swivel magnet, rotating clip for hanging and feature protective bumper and special ergonomic grip. On/off switch and outlet in handle.

Length: 35'
Cord: 16/3 SJT
Bulb: 13 watt
Amp: 10
Watt: 1250



KTI73333

Fluorescent Angle Light on Reel 50' 26 Watt 14/3

Fluorescent work lights are cool to the touch and energy efficient. All fluorescent lights are UL and cUL approved. All angle lights have 360 degree swivel magnet, rotating clip for hanging and feature protective bumper and special ergonomic grip. On/off switch and outlet in handle.

Length: 50'
Cord: 14/3 SJT
Bulb: 26 watt
Amp: 13
Watt: 1625



KTI73318

Fluorescent Tube Light on Reel 50'

13 Watt 18/2

Fluorescent work lights are cool to the touch and energy efficient. All fluorescent lights are UL and cUL approved. Adjustable hanging hook swivels 360 for easy hanging. On/off switch located in handle.

Length: 50' with reel
Cord: 18/2 SJT
Bulb: 13 watt



KTI73303

Fluorescent Tube Light 25'

13 Watt 18/2

Fluorescent work lights are cool to the touch and energy efficient. All fluorescent lights are UL and cUL approved. Adjustable hanging hook swivels 360 degree for easy hanging. On/off switch located in handle.

Length: 25'
Cord: 18/2 SJT
Bulb: 13 watt



KTI73312
Fluorescent Angle
Work Light 25'
26 Watt 16/3

Fluorescent work lights are cool to the touch and energy efficient. All fluorescent lights are UL and cUL approved and have circuit breaker protection and grounded outlet. All angle lights have 360° swivel magnet, rotating clip for hanging and feature protective bumper and special ergonomic grip. On/off switch.

Length: 25'
 Cord: 16/3 SJT
 Bulb: 26 watt
 Amp: 13
 Watt: 1625



KTI73311
Fluorescent Angle
Work Light 25'
13 Watt 16/3

Fluorescent work lights are cool to the touch and energy efficient. All fluorescent lights are UL and cUL approved and have circuit breaker protection and grounded outlet. All angle lights have 360 degree swivel magnet, rotating clip for hanging and feature protective bumper and special ergonomic grip. On/off switch.

Length: 25'
 Cord: 16/3 SJT
 Bulb: 13 watt
 Amp: 13
 Watt: 1625



KTI73304
Replacement Head
13 Watt Fluorescent
Tube Light

Light head only, no cords attached.
 Complete with bulb.



KTI73305
Replacement Head
13 Watt Fluorescent
Angle Light

Light head only, no cords attached.
 Complete with bulb.



KTI73306
Replacement Head
26 Watt Fluorescent
Angle Light

Light head only, no cords attached.
 Complete with bulb.



KTI73349
Replacement
Metal Cage for
Industrial Trouble Light

Metal guard and cage for use with incandescent trouble lights. Bulb and light not included.



KTI73357
Replacement Lens
Angle Light 13 Watt
 Replacement part for fluorescent light.



KTI73356
Replacement Lens
Angle Light 26 Watt
 Replacement part for fluorescent light.

Standard Trouble Light
Replacement Parts

- KTI73350** - Replacement metal guard only
- KTI73351** - Replacement handle/switch assembly only
- KTI73355** - Replacement metal guard with handle/switch assembly



KTI73370 **Halogen Work Light 500 Watt**

Illuminate the workshop, garage or job site with the power of bright halogen light. All KTI fixtures use a 500-watt quartz halogen bulb (included), which emits brighter, whiter light and uses less energy. Features include: 5-foot power cord and small floor stand.

Length: 5'
Cord: 18/3 SJTW



KTI73372 **Halogen Work Light 500 Watt with 6' Tripod Stand**

Illuminate the workshop, garage or job site with the power of bright halogen light. All KTI fixtures use a 500-watt quartz halogen bulb (included), which emits brighter, whiter light and uses less energy. Features include: on/off switch, 5-foot cord and 6-foot tripod floor stand.

Length: 5'
Cord: 18/3 SJTW

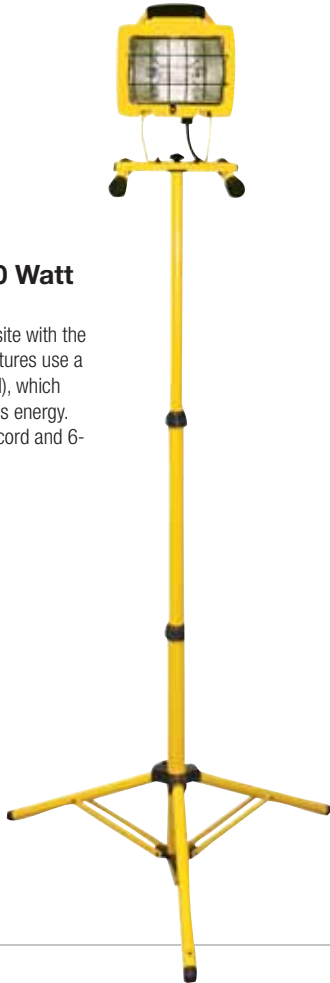

KTI73375 **Halogen Work Light 1000 Watt with 6' Tripod Stand**

Illuminate the workshop, garage or job site with the power of bright halogen light. Fixture uses two 500-watt quartz halogen bulb (included), which emit brighter, whiter light and uses less energy. Features include: on/off switch, 5-foot cord and tripod floor stand.

Length: 5'
Cord: 18/3 SJTW



KTI73307 **Replacement Bulb** **13 Watt Fluorescent**

Replacement bulb for all KTI 13 watt work lights (angle and compact tube).



KTI73371 **Replacement Bulb** **500 Watt Halogen**

Replacement bulb for all KTI halogen work lights (models 73370, 73372 and 73375)





Exclusive Folding Option



KT173386
30 SMD LED Rechargeable
Folding Underhood Worklight

- 30 LED SMD worklight with 7.4 volt / 2000 mAh Li battery
- 6 Hour charge time
- 3.5 hour approximate run time
- Aluminum and ABS housing
- Telescopic ends slide to a maximum of 74.75"
- Two soft rubber covered brackets allow attaching the light to work area
- Hi / Low / Off operation modes
- AC & DC chargers included
- Full extension length: 50.375"
- Folded length: 26.875"



KTI73373

24 SMD LED Rechargeable Worklight

- 24 SMD LED (800 lumens) Rechargeable Worklight
- Heavy duty face plate
- Features a ratcheting head
- Foam insulated handle
- On / Off switch
- Charge time: 2 hours
- Run Time: 2 hours full strength

Rechargeable worklight. 24 element SMD LED with 800 lumen output. The face plate is heavy duty that contains the on/off switch on the reverse side. Has a ratcheting head and foam insulated handle. Weight: 4.85 lbs, length: 10.75" width: 9.75", height: 15"



KTI73374

24 SMD LED A/C Power Worklight with 3 foot 18/3 SJTW Cord

- 24 SMD LED (800 lumen) A/C Power Worklight with 3 foot 18/3 SJTW cord
- Heavy duty face plate
- Features a ratcheting head
- Foam insulated handle
- On / Off switch

A/C Power worklight with 3 ft.18/3 SJTW cord. 24 element SMD LED with 800 lumen output. The face plate is heavy duty that contains the on/off switch on the reverse side. Has a ratcheting head and foam insulated handle. Worklight LED 800 Lumen 3ft 18/. Weight: 4.85 lbs, length: 10.75" width: 9.75", height: 15"



KTI73393

30-Element LED Rechargeable Work Light

The 30-element LED floodlight provides ample lighting for any work area. Bright, white LEDs illuminate large areas and provide 180 lumens of lighting power. A single-element LED spotlight provides direct-focused lighting where it is needed. A super-bright LED provides 100 lumens of lighting power in a concentrated beam. The magnetic base holds flashlight firmly in place to focus light directly on work areas. The extra-strength magnet is powerful enough to position the flashlight vertically or horizontally. Worklight features durable construction of military-grade aerospace aluminum. This LED flashlight is rugged enough to be used in the toughest shop environments yet lightweight and easy-to-use. The unique hexagon design allows users to position the light on a flat surface in order to direct light to work area. Hexagon-shaped ends also prevent flashlight from rolling off surfaces. Rechargeable 3.6V batteries can be charged with a 120 volt AC adapter or a 12 volt DC adapter (both included). Approximate battery life on a full charge is 4 hours.



KTI73394

60-Element LED Rechargeable Work Light

The element LED floodlight provides ample lighting for any work area. Bright, white LEDs illuminate large areas and provide 180 lumens of lighting power. A single-element LED spotlight provides direct-focused lighting where it is needed. A super-bright LED provides 100 lumens of lighting power in a concentrated beam. The magnetic base holds flashlight firmly in place to focus light directly on work areas. The extra-strength magnet is powerful enough to position the flashlight vertically or horizontally. Worklight features durable construction of military-grade aerospace aluminum. This LED flashlight is rugged enough to be used in the toughest shop environments yet lightweight and easy-to-use. The unique hexagon design allows users to position the light on a flat surface in order to direct light to work area. Hexagon-shaped ends also prevent flashlight from rolling off surfaces. Rechargeable 3.6V batteries can be charged with a 120 volt AC adapter or a 12 volt DC adapter (both included). Approximate battery life on a full charge is 4 hours.



KTI73387
Rechargeable Worklight
3W COB with Pivot Head

- Rechargeable 3W COB LED
- 3.7 volt 2200 mAh Li battery
- 5 hours with run time being approximately 2 hours
- ABS and rubberized housing
- Super strong magnetic base
- Rotating hook at the top that can be turned down
- 80 degree pivoting head with 180 degree rotating light
- AC & DC chargers included

KTI73396
Aluminum 16 LED Flashlight

- 16 LED (96 lumens) flashlight
- Aerospace grade aluminum body
- Rubber grip handle
- Belt holster included
- 3 - AAA batteries included



KTI73388
3 Watt COB
LED Rechargeable Worklight

- 3.7 volt / 22000 mAh Li battery
- Charge time about 5 hours with 2 hour run time
- ABS and rubberized housing with a magnet on the back side and a clip for hanging
- AC & DC chargers included

Rechargeable 3W COB LED with 3.7 volt 2200 mAh Li battery. Charging time is about 5 hours with run time being approximately 2 hours. ABS and rubberized housing with a magnet on the back side and a clip for hanging. AC & DC chargers included.

KTI73399
12 SMD LED
Rechargeable Worklight

- Rechargeable 12 SMD LED worklight
- ABS and rubberized housing
- Magnet on the back side
- Rotating hook on the top
- Hi / Low / Off switch



Rechargeable 12 SMD LED worklight. ABS and rubberized housing with a magnet on the back side and a rotating hook on the top. Hi / low / off switch. Charge time: 5 hours. Run time: 2 hours.

KTI73397
48 LED Worklight
with 25 foot 16/3 SJT Power Cord

- Super bright 48 element LED worklight
- 25 foot 16/3 SJT power cord
- 15 AMP outlet in handle
- Clamped magnet attaches to center
- Two swivel hooks that fold down

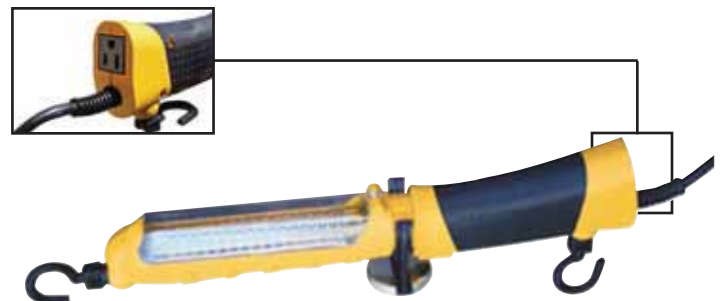

KTI73398 Hands Free 14 LED Headlamp

- 14 LED (75 lumens) headlamp
- Hi / Low / Off switch
- Adjustable headband
- Ratchets up/down for focus direction
- Approximate 7 hour run time
- 3-AAA batteries (included)



KTI73389 Slimline 6 LED Rechargeable Inspection Light

- Super slim head at 1/4" thick by 11/16" wide
- Up to 7 hours of light on a single charge
- Generates 200 lumens at 15 feet
- Micro USB receiver allows for multiple charging options
- 3.7 volt Li-ion / 2200 mah rechargeable battery

Super Slim 6 LED Rechargeable LED Inspection Lamp. Thin head, 1/4" thick by 11/16" wide allows for inspection in tight quarters. Micros USB receiver allows for multiple charging options. Up to 7 hours of light on a single charge. 3.7 volt Li-ion / 2200mah rechargeable battery. Generates 200 lumens at 15 feet. Weighs only 6 oz.



KTI79800 Emergency Safety Flare

- Non-chemical safety flare
- Nine flash patterns including the USCG approved SOS
- Positive Buoyancy
- Runs up to 100 hours on replaceable CR-123 non-rechargeable battery
- Shatter, crush, and water resistant

A non-chemical environmentally safety flare. Applications in automotive, industrial, and marine. Nine distinctive flash patterns for emergency situations and work areas.



KTI79801 Rechargeable Emergency Safety Flare

- Runtime up to 50 hours depending on flash pattern
- Non-chemical safety flare
- Nine flash patterns including the USCG approved SOS
- Shatter-proof, crush-proof, and water resistant
- Non-chemical safety flare
- Positive buoyancy
- Charger adapter included

A non-chemical, environmentally safety flare. Applications in automotive, industrial, and marine. Nine distinctive flash patterns for emergency situations and awareness in work areas. 1 Year Warranty.



Battery Testers and Booster Cables

Battery Testers and Booster Cables



KTI70211 Antifreeze Tester

Hydrometer immediately and accurately tests strength of all permanent solutions (ethylene glycol), with engine hot or cold, and includes temperature adjustment scale for accurate interpretation of mixture strength. Assists in preventing winter freezeup and summer boilover. Two embedded scales show freeze point of radiator solution and boiling point of summer coolant.

**LIFETIME
WARRANTY***



KTI70212 Battery Tester

Hydrometer immediately and accurately tests battery life whether battery is hot or cold. Helps extend battery life and detects overcharge. Assists in preventing dead batteries. Works on all 6-, 12- and 24-volt systems.

**LIFETIME
WARRANTY***

KTI70215 Battery Tester 100 AMP

Extremely handy and portable way to load test suspected low charging batteries. Internal 100 AMP loading capacity. Test 6- and 12-volt batteries. Tool checks battery voltage, starter current draw, charging voltage and battery condition. Features extra-heavy nickel-plated ventilated case, heavy-duty cable, copper-plated clamps, and load safety switch to prevent arcing.

Warranty information:

1-year warranty. Repair or replace at discretion of repair center.



KTI70216 Digital Battery Tester 125 AMP

Extremely handy and portable way to load test suspected low charging batteries. Internal 125 AMP loading capacity. Digital voltage indicator with LED battery status. Tests 12-volt batteries on or off the vehicle. Load safety switch prevents arcing. Features extra-heavy nickel-plated ventilated case, heavy-duty cable, copper-plated clamps, and load safety switch to prevent arcing.

Warranty information:

1-year warranty. Repair or replace at discretion of repair center.





KT174308
Automotive OBD2
Connector - Computer
Memory Saver

KTi's OBDII Memory Saver retains a vehicle's electronic memory presets (radio, GPS, seats and accessories) while the vehicle battery is disconnected. OBDII cord connects to any 12V portable power source. Memory Saver will not interfere with the vehicle's fault codes. A visual LED indicator illuminates when cord is properly connected to power source to ensure no loss of electronic memory due to improper connection. An extra-long 8-foot cord makes it easy to use on any vehicle.

Warranty information:
 1-year limited warranty.



KT170210
Carbon Pile Load
Tester 500 AMP

KTi's 500 AMP carbon pile load tester is great for simulating actual cranking loads. It tests 12 volt batteries rated as high as 1000 CCA or 160 AMP hour. Quick 15 second test cycle with audible tone to indicate test completion. Unit can also test alternators, regulators and starters. Carbon pile load tester features 500 AMP side clamps and heavy-duty stranded copper cables. The large, color-coded dual meters make the unit easy-to-use. Also includes temperature compensation chart.

Warranty information:
 1-year warranty. Repair or replace at discretion of repair center.



KT174536
400 Amp Booster Cable
Replacement Clamps

- Vinyl coated clamps help prevent rust and corrosion



KT174537
500 Amp Booster Cable
Replacement Clamps

- Vinyl coated clamps help prevent rust and corrosion



KT174538
800 Amp Booster Cable
Replacement Clamps

- Vinyl coated clamps help prevent rust and corrosion



KT170220
Battery Terminal
Cleaner

All metal battery terminal cleaner promotes longer battery life.



KT174535
Booster Cable
Replacement Clamps
500 AMP Parrot Jaw

500 AMP parrot jaw clamps. Replacement side terminal extension cable clamps for professional grade booster cables. Sold in pairs.

Battery Testers and Booster Cables

KTI74500 **Economy** **12' Battery** **Booster Cables** **250 AMP - 10 Gauge**

Durable rubber booster cables that resist extreme temperatures, oil and chemicals. Light-duty.

Warranty information:
1-year limited warranty.



KTI74505 **Medium-duty** **12' Battery** **Booster Cables** **250 AMP - 8 Gauge**

KTI's durable rubber booster cables resist extreme temperatures, oil and chemicals, and meet or exceed all SAE standards. Twelve foot medium-duty cables include side/top clamps and 8 gauge wires with 250 AMP clamps.

Warranty information:
1-year limited warranty.



KTI74510 **Heavy-duty** **16' Battery** **Booster Cables** **400 AMP - 6 Gauge**

KTI's durable rubber booster cables resist extreme temperatures, oil and chemicals, and meet or exceed all SAE standards. Sixteen foot heavy-duty cables include side/top clamps and 6 gauge wires with 400 AMP clamps.

Warranty information:
1-year limited warranty.



KTI74530 **Professional** **25' Battery** **Booster Cables** **500 AMP - 2 Gauge**

KTI's durable rubber booster cables resist extreme temperatures, oil and chemicals, and meet or exceed all SAE standards. Twenty-five foot professional cables include parrot-jaw clamps and 2 gauge wires with 500 AMP clamps.

Warranty information:
1-year limited warranty.



KTI74523 **20' Heavy Duty** **4 Gauge 500 Amp Clamps**

- Booster cables have a tangle-free design
- Flexible to -40 degree Fahrenheit temperatures
- Vinyl coated clamps help prevent rust and corrosion
- For side and top battery post



KTI74524 **20' Heavy Duty** **4 Gauge 400 Amp Clamps**

- Booster cables have a tangle-free design
- Flexible to -40 degree Fahrenheit temperatures
- Vinyl coated clamps help prevent rust and corrosion
- For side and top battery post



KTI74521 **Extra-Heavy-Duty 16' Battery Booster** **Cables 400 AMP - 4 Gauge**

KTI's durable rubber booster cables resist extreme temperatures, oil and chemicals, and meet or exceed all SAE standards. Sixteen foot extra-heavy-duty cables include side/top clamps and 4 gauge wires with 400 AMP clamps.

Warranty information:
1-year limited warranty.





Creepers, Carts and Tool Storage

Creepers, Carts and Tool Storage

KTI74951

36-inch Metal Frame Creeper with Rubber Casters

KTI 36" metal frame creeper features a fully padded seat for comfort.

- Rugged, durable construction for a lifetime of use.
- Six (6) 2-inch oil-resistant rubber casters provide smooth mobility.
- Steel frame is epoxy-coated to prevent rusting.
- Four (4) cross rails provide added support.
- Assembly required.

Replacement parts:

KTI74959 - replacement caster

Warranty information:

90-day limited warranty.



KTI74956

40-inch Metal Frame Creeper with Rubber Casters

KTI 40" metal frame creeper features a fully padded seat for comfort.

- Rugged, durable construction for a lifetime of use.
- Six (6) 2-inch oil-resistant rubber casters provide smooth mobility.
- Steel frame is epoxy-coated to prevent rusting.
- Four (4) cross rails provide added support.
- Assembly required.

Replacement parts:

KTI74959 - replacement caster

Warranty information:

90-day limited warranty.



KTI74961

40-inch Metal Frame Creeper with Adjustable Headrest

KTI 40" metal frame creeper features a fully padded seat for comfort.

- Adjustable headrest is comfortable and convenient for every use.
- Rugged, durable construction for a lifetime of use.
- Six (6) 2-inch oil-resistant rubber casters provide smooth mobility.
- Steel frame is epoxy-coated to prevent rusting.
- Four (4) cross rails provide added support.
- Assembly required.

Replacement parts:

KTI74959 - replacement caster

Warranty information:

90-day limited warranty.



KTI74971 **Padded Mechanic's** **Creepers Seat** **with Pneumatic Lift**

- Round, adjustable mechanic's seat features fully padded 12" seat for added comfort.
- Seat is adjustable by pneumatic cylinder from 14" to 19".
- Large steel base also serves as storage for tools while working.
- Features five (5) 2-1/2" oil-resistant rubber casters for smooth mobility.
- Assembly required.

Replacement parts:

KTI74957 - replacement caster

Warranty information:

90-day limited warranty.



KTI74981 **Padded Mechanic's Creepers Seat** **with Storage Tray**

- Mechanic's seat with plastic storage tray.
- Fully padded seat measures 7" x 14".
- Plastic tray has three sections to store tools or small parts.
- Features four (4) 2-1/2" oil-resistant rubber casters for smooth mobility.
- Metal frame is epoxy-coated to prevent rusting.
- Assembly required.

Replacement parts:

KTI74958 - replacement caster

Warranty information:

90-day limited warranty.



KTI74900 **9" x 20"** **Kneeling Pad with Handle**

- Ideal for automotive, home or garden use.
- Urethane closed cell foam prevents moisture from soaking into foam.
- Durable easy-to-clean neoprene fabric with carry handle.
- Measures: 9" x 20".



Creepers, Carts and Tool Storage



Two gas struts in lid for ease in opening or closing. Hinged lid opens completely for greater access to tools. Piano-style hinge for added durability.

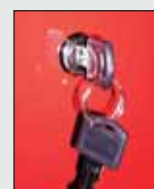

Top locking tray keeps tools safe and secure when not in use. Drawers will not function when top storage tray is closed.

Top drawer dimensions (each)
11-1/2" W x 16-7/8" D x 4-1/2" H

Middle drawer dimensions
24-1/2" W x 16-7/8" D x 2-1/2" H

Bottom drawer dimensions
24-1/2" W x 16-7/8" D x 4-1/2" H

4-drawer overall dimensions
39" W x 19-1/2" D x 41-1/4" H

Heavy-duty 5" x 2" casters. Two casters feature easy-to-operate locking mechanism to keep cart from rolling.



4-drawer Utility Carts

- Part numbers:
- KTI75140** - Red
 - KTI75141** - Blue
 - KTI75142** - Teal
 - KTI75143** - Yellow
 - KTI75145** - Black

Warranty info: 1-year warranty.



Features 22-slot screwdriver and/or prybar holder allowing handles to be stowed in top locking tray.



Store large-handle pry bars (up to 10") that won't fit in the top storage tray. Piano-style hinge folds down completely for easy access to pry bars, screwdrivers and other tools. Includes 22 slots and measures 18½" x 12" x 4".

Features side storage tray. Perfect for storage of tall items including aerosol cans.



Large drawers and trays to hold and organize tools. All drawers and trays include liners made of non-toxic EVA.



Drawers feature all steel ball bearing slides for smooth, quiet operation.



Keep drawers closed securely until needed. Easy, one-hand operation. Drawer locks can only be operated when top lid is open.

Large bottom storage tray. Extra storage for oversized items. Great for shop towels, gallon-size containers and other large shop accessories.



KTI75105 One-Drawer Steel Service Tool Cart with 2 Lined Shelves

Durable construction for rugged shop environments. Sturdy, one-piece drawer handle. Cart provides ample storage. Large, fully-lined top and bottom storage trays to organize tools, shop accessories and parts for greater accessibility. Fully-lined drawer with lock to securely store tools when not in use. Four casters allow steady, quick movement. Two casters feature easy-to-operate locking mechanism to keep cart from rolling. Easy-to-assemble. Cart ships complete with all necessary hardware and instructions. Available in red only.

Warranty information: 1-year warranty.



KTI75146 4 Drawer Locking Service Cart

- 500 lb. load capacity
- 5" Heavy-duty casters
- Side impact bumpers
- Gas shocks for lid
- Ball bearing drawer slides. Drawer liners for all drawers and trays
- Cart dimensions: 148 lbs, 35.2" length, 20.6" width, 40.3" height. Top drawer depth (2) 3", Middle drawer depth 3", Bottom drawer depth 6"

Creepers, Carts and Tool Storage

KTI72451

Magnetic Tool Hanger for Air Impact - 20 lb. Capacity

- Effortlessly holds most pistol-type impact wrenches.
- Screw-hole design allow for easy mounting to nonferrous surface.
- Magnetic mount supports up to 20 lbs.



LIFETIME WARRANTY*

KTI72450

Magnetic Tool Hanger 11 lb. Capacity

- Holds heavy and irregularly shaped tools, such as hammers, mallets and wrenches.
- Ideal for storing cords, shovels, and more.
- Screw-hole design allow for easy mounting to nonferrous surfaces.
- Magnetic mount supports up to 11 lbs.



LIFETIME WARRANTY*

KTI72465

Magnetic Tool Holder Multipurpose 15 lb. Capacity

- Holds a variety of screwdrivers, pliers, sockets, wrenches, hammers and more.
- Firmly attaches to metal surface.
- Extends up to 20" wide.
- Each socket seat encases a powerful magnet.
- Special hooks hold wrenches, keys and other hard to store items.
- Permanently mount using screw holes or built in magnets support up to 15 lbs.
- Stores up to 71 tools.

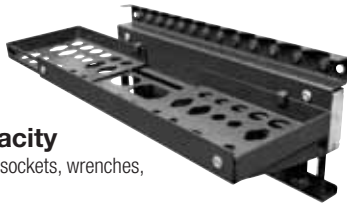

LIFETIME WARRANTY*

KTI72460

Magnetic Tool Box 33 lb. Capacity

- Powder-coating finish protects holder even in rugged, professional environments.
- Chamfer design holds various tools, such as cans, brushes and tape.
- Organize workshops, garages and manufacturing sites.
- Screw-hole design allows for easy mounting to nonferrous surfaces.
- Portable holder goes from job to job.
- Holds up to 33 lbs.



LIFETIME WARRANTY*

MAG-CLIP
By K-Tool International®

K TOOL
INTERNATIONAL

Socket Caddy

This organizer allows users to customize the storage and organization of some of the messiest areas of the average tool box, such as the socket drawer. The base of this product is made out of a high impact plastic magnetic grid. Use with additional Power Pegs (sold separately) in any combination of 3 drive sizes to customize your workspace.

Other Features:

- Shallow or deep sockets
- Standard or metric sockets
- Will not magnetize sockets
- Magnets retain strength permanently
- Grease, oil and chemical resistant
- Tough polymer base
- Rust resistant

Includes

28 interchangeable Power Pegs.

MCP72421 - 1/4" drive

MCP72422 - 3/8" drive

MCP72423 - 1/2" drive

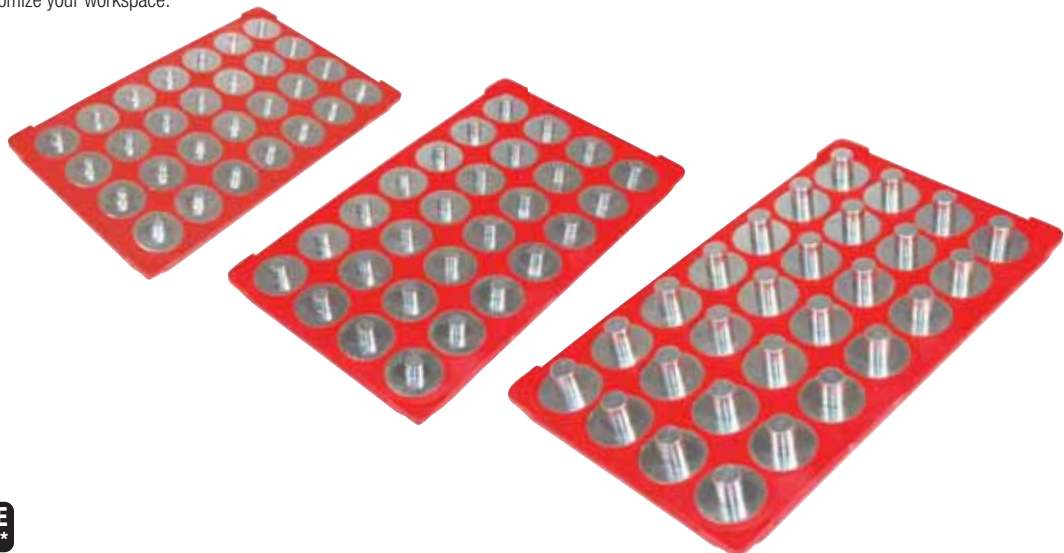

1/4" Drive **3/8" Drive** **1/2" Drive** **LIFETIME WARRANTY***

MAG-CLIP

By K-Tool International®

Original Mag-Clip Strip

Magnetic socket holders hold sockets tight without magnetizing them. Hangs or mounts on any smooth metal surface.

Other Features:

- Shallow or deep socket
- Standard or metric sockets
- Holds socket tight and secure on any smooth metal surface
- Will not magnetize sockets
- Magnets retain strength permanently
- Grease, oil and chemical resistant
- Tough polymer base
- Rust resistant

MCP72401 - 1/4" drive
MCP72402 - 3/8" drive
MCP72403 - 1/2" drive

1/4" Drive 3/8" Drive 1/2" Drive LIFETIME WARRANTY*

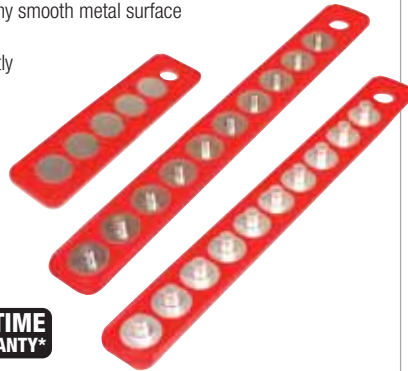

MCP72460

Universal Mag-Clip

Use the Universal Mag-Clip Strip to hold wrenches, screwdrivers, pliers and other hand tools to keep them at your fingertips.

Other Features:

- Mounts on any smooth metal surface
- Holds tools tight and secure
- Reverse polarity magnetic power
- Magnets retain strength permanently
- Grease, oil and chemical resistant
- Tough polymer base
- Rust resistant

LIFETIME WARRANTY*

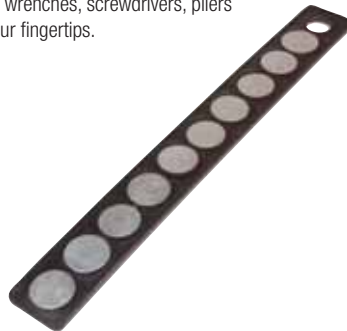

Mag Mount

The Mag Mount is a magnetic tool storage and/or mounting system for use with pegboard. The Mag Mount will hold tools securely without the use of hooks or bars. This design will work with 1/8" and 1/4" pegboard and features "super duty" magnetic power. Includes screws for 1/8" and 1/4" pegboard.

MCP72453 - 3 pack
MCP72455 - 5 pack



Power Pegs

Interchangeable steel posts available in 1/4", 3/8" and 1/2" drive sizes. Use Power Pegs with MagKanic Mat, Power Mat, Socket Caddy or Interchangeable Mag-Clip Strip for the ultimate storage system. 10 pack.

MCP72441 - 1/4" drive
MCP72442 - 3/8" drive
MCP72443 - 1/2" drive

1/4" Drive 3/8" Drive 1/2" Drive LIFETIME WARRANTY*



MAG-CLIP

By K-Tool International®

Interchangeable Mag-Clip Strip

Magnetic socket holders hold sockets tight without magnetizing them. Use with additional Power Pegs (sold separately) in any combination of 3 drive sizes to customize your workspace.

Other Features:

- Shallow or deep socket
- Standard or metric sockets
- Holds socket tight and secure on any smooth metal surface
- Will not magnetize sockets
- Magnets retain strength permanently
- Grease, oil and chemical resistant
- Tough polymer base
- Rust resistant

Includes 10 interchangeable Power Pegs.

MCP72400 - 1/4" drive
MCP72404 - 3/8" drive
MCP72405 - 1/2" drive

1/4" Drive 3/8" Drive 1/2" Drive LIFETIME WARRANTY*

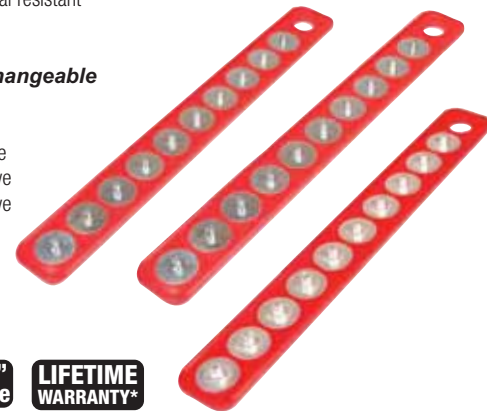

Magnetic Mat

The mat is a magnetic, convertible and interchangeable means for storing and organizing sockets. Customize any tool box and utilize storage space in the most unlikely areas. Versatile enough to be used in drawers to organize sockets or simply flip the mat over to the rubber side and store a variety of other tools in a vertical position. The flexible design makes the magnetic mats your most versatile tool...use it almost anywhere you can imagine. High powered magnets are imbedded in a flexible, high impact poly-pro body. May be used with Power Pegs (sold separately) in any combination of 3 drive sizes (1/4", 3/8" or 1/2") to customize your workspace.

MCP72424 - 2-panel MagKanic Mat
MCP72425 - 3-panel Power Mat
MCP72426 - 3-panel Power Mat with 84 assorted power pegs



1/4" Drive 3/8" Drive 1/2" Drive LIFETIME WARRANTY*



Shop Equipment

KT160060 Heavy-Duty 6" Bench Grinder

KT1's bench grinder features a cast iron motor housing for heavy-duty applications and long life. The fully adjustable acrylic eye shields deflect sparks away from operator for added safety. The KT1 bench grinder includes one course (36-grit) grinding wheel and a wire wheel for grinding and sharpening. Two adjustable tool rests are perfect to accommodate a variety of uses and provide additional stability for precision grinding. The 1/3 horsepower, 115 volt motor boasts 3,450 rpm no load speed. KT1's bench grinder is UL listed.



Warranty information:
1-year limited warranty.

Steel Bench Vises

Rugged all-steel vise is stronger than its cast iron counterpart. Vise features swivel base and large anvil space for hammering.

KT164105 - 5" vise	5-1/4" usable jaw opening	27 lbs.
KT164106 - 6" vise	6-1/2" usable jaw opening	35 lbs.
KT164108 - 8" vise	8-1/2" usable jaw opening	50 lbs.

Replacement parts:

KT164001 - Replacement screws	KT164006 - 6" jaws
KT164005 - 5" jaws	KT164008 - 8" jaws



Warranty information:
10-year limited warranty. Jaws are not covered.



KT163201 2 Ton Bottle Jack

- Capacity: 2 Tons
- Lifting Range: 6.2" to 12.1"
- Ram extension screw adjusts low height to get full use of ram travel
- Load-limiting and bypass valves prevent against over loading and over extension
- Ductile iron hydraulic base for added strength

Warranty information:
1-year warranty.



KT163207 6 Ton Bottle Jack

- Capacity: 6 Tons
- Lifting Range: 7.75" - 15.04"
- Ram extension screw adjusts low height to get full use of ram travel
- Load-limiting and bypass valves prevent against over loading and over extension
- Ductile iron hydraulic base for added strength

Warranty information:
1-year warranty.



Shop Equipment



XD Bottle Jacks

- Ram extension screw adjusts low height to get full use of ram travel
- Load-limiting and bypass valves prevent against over loading and over extension
- Ductile iron hydraulic base for added strength

KTI63213 Capacity: 12 Tons, Lifting Range: 8.46" - 15.75"

KTI63221 Capacity: 20 Tons, Lifting Range: 9.6" - 16.65"

Warranty information:
2-year warranty.



Short XD Bottle Jacks

- Ram extension screw adjusts low height to get full use of ram travel
- Load-limiting and bypass valves prevent against over loading and over extension
- Ductile iron hydraulic base for added strength

KTI63214 Capacity: 12 Tons, Lifting Range: 7.48" - 13.78"

KTI63224 Capacity: 20 Tons, Lifting Range: 7.25" - 11.75"

Warranty information:
2-year warranty.



KTI63230 30 Ton Bottle Jack

- 30 ton bottle jack with lift range from 11.2" to 18.27"
- Thick steel hydraulic base for maximum strength
- Three-piece snap-fit pump handle for easy pumping and storage
- Carrying handle included
- Load-limiting and bypass valves prevent against over loading and over extension of ram

Warranty information:
2-year warranty.



KTI63250 50 Ton Bottle Jack

- 50 ton bottle jack with lift range from 11.8" to 18.8"
- Thick steel hydraulic base for maximum strength
- Three-piece snap-fit pump handle for easy pumping and storage
- Carrying handle included
- Load-limiting and bypass valves prevent against over loading and over extension of ram

Warranty information:
2-year warranty.



KTI63228 20 Ton Air Hydraulic Bottle Jack

- Capacity: 20 Tons
- Lifting Range: 10.43" - 19.88"
- Air/hydraulic pump with air valve lever reduces lifting time and provides ease of operation
- Load limiting and bypass valves prevent use beyond rated capacity and over extension of ram
- Additional adjustable screw 3.25"

Warranty information:
2-year warranty.





Jack Stands

- Designed to be used in pairs
- Steel base with four feet pads for stability
- Ratchet action design with ductile iron support column

KTI61202 3 Ton Jack Stands, Lifting Range: 11.6" to 16.7"

KTI61205 6 Ton Jack Stands, Lifting Range: 15.75" to 24"

Warranty information:
2-year warranty.



KTI61211 12 Ton Jack Stands

- Capacity: 12 Tons
- Lifting Range: 19.63" to 30.25"
- Steel square base with foot pads for added strength and stability
- Ductile iron column supports load off the ground
- Weight: 52.9 lbs

Warranty information:
2-year warranty.



KTI61222 22 Ton Jack Stands

- Pair of 22 ton capacity pin type jack stands with support range from 11.825" to 19.75"
- Height adjustment pin connected to base by way of lanyard to prevent against loss
- Steel plate and structural tubing for added strength and stability
- V-shaped saddle to cradle axles and other truck components
- Sold and to be used in pairs

Warranty information:
2-year warranty.



KTI61076 3/4 Ton Utility Underhoist Stand

- 3/4 ton under hoist stand designed to support under car components
- Support range from 53" to 79"
- Acme threaded screw for self-locking positioning
- Bearing mounted spin handle for easy raising and lowering of screw
- 12" diameter base with 1.63" x 5.5" saddle provide additional support

KTI61077 3/4 Ton Utility Underhoist Stand With Pedal

- 3/4 ton under hoist stand designed to support under car components
- Support range from 53" to 79"
- Acme threaded screw for self-locking positioning and foot pedal to raise screw another 1.25" under 400 pounds of load
- Bearing mounted spin handle for easy raising and lowering of screw
- 12" diameter base with 1.63" x 5.5" saddle provide additional support

Warranty information:
2-year warranty.



KTI61002 2 Ton Tripod Underhoist Stand

- 2 ton under hoist stand designed to help stabilize a vehicle suspended by an above-ground lift
- Support range from 68" to 76"
- Acme threaded screw for 8" of fine adjustment
- Bearing mounted spin handle for easy raising and lowering of screw
- 24" triangle shaped base and 3.25" square saddle provide additional stability

Warranty information:
2-year warranty.



Shop Equipment

KTOOL XD
INTERNATIONAL



KT162108 800 Lb. H-Style Engine Stand

- Capacity: 800 lbs
- H-frame design base with four wheels provides stability
- Stand made of structural steel tubing for strength and light enough for easy maneuverability
- Fully adjustable mounting head and adapter fingers
- Weight: 49.8 lbs

Warranty information:
2-year warranty.

KTOOL XD
INTERNATIONAL



KT162110 1000 Lb Geared Engine Stand

- 1000 pound capacity foldable engine stand for convenient storage when not in use
- Worm gear driven mounting plate with adjustable fingers rotates for desired engine position
- Four wheel design with locking caster wheels to prevent stand from moving
- Made of structural steel plate and tubing for added strength
- Weighs 92 lbs

Warranty information:
2-year warranty.



KTOOL XD
INTERNATIONAL

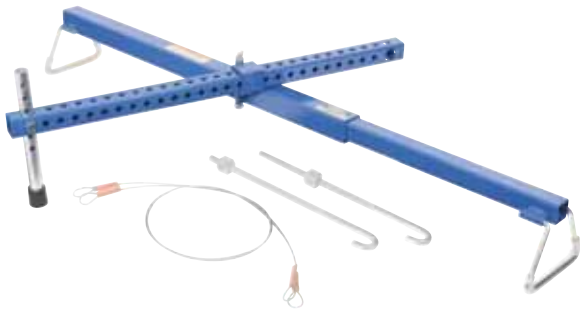

KT162114 700 Lb Engine Support Bar

- 700 pound capacity
- Transverse support bar adjusts from 34.5" to 61"
- Designed to support front wheel drive engines for repair or motor mount replacement
- Includes support leg for heavier engines or engines requiring three point support
- Engine attachment and adjustment hardware provided

Warranty information:
2-year warranty.

KTOOL HD
INTERNATIONAL



KT162116 1000 Lb Engine Support Bar

- Designed to support front wheel drive engines for repairs or servicing of engine mounts
- Includes a 700 pound capacity transverse bar that extends from 34.5" to 61"
- Includes a support leg for handling larger engines or engines requiring three support points
- Engine attachment and adjustment hardware included
- Weight 41.9 lbs

Warranty information:
2-year warranty.



KT162115
1500 Lb. Engine Sling

- 1500 pound capacity engine sling for use with an engine crane
- Designed to level a load or adjust at a specific angle for installation and removal
- Hand crank and bearing mounted drive screw for easy adjustment
- Four mounting chains and brackets for quick attachment to engine
- Weighs 14.3 lbs

Warranty information:
2-year warranty.



KT163414
4 Ton Long Ram

- 4 ton long ram bottle jack for farm applications and replacement power unit for engine cranes
- Lift range from 19.7" to 34.7".
- * Release valve slowly controls the lowering of load
- Load-limiting and bypass valves to prevent overloading and over extension of ram
- Long handle for easy pumping effort under load
- Hole in top of ram for receiving mounting bolt

Warranty information:
2-year warranty.



KT163427
8 Ton Long Ram

- 8 ton long ram bottle jack for farm applications and replacement power unit for engine cranes
- Lift range from 24" to 42.7".
- * Release valve slowly controls the lowering of load
- Load-limiting and bypass valves to prevent overloading and over extension of ram
- Long handle for easy pumping effort under load
- Hole in top of ram for receiving mounting bolt

Warranty information:
2-year warranty.



KT163421
1.5 Ton Foldable Engine Crane
With Fast Rise

- 750 Lbs. / 1,500 Lbs. / 2,250 Lbs. / 3,000 Lbs. capacity engine crane with four different boom positions
- Legs and boom fold quickly for storage
- Fast rise pump without a load
- 48" long boom with chain and swivel hook included
- 4.25" low profile base for easy access under low ground clearance vehicles

Warranty information:
2-year warranty.



Shop Equipment



KTI63101 2 Ton Low Profile Service Jack

- 2 ton capacity low profile service jack for easy access under low ground clearance vehicles
- Lift range from 3.5" to 18.1"
- 45.25" long pump handle for easy pumping under load
- Dual pump piston power unit raises saddle to maximum height in 6.5 full incremental pump strokes with no load
- Load-limiting and bypass valves to prevent use beyond rated capacity and over-extension of ram

Warranty information:
2-year warranty.



KTI63105 2 Ton Extra Long Low Profile Service Jack

- 2 ton capacity extra long low profile service jack for easy access under low ground clearance vehicles
- Lift range from 2.75" to 24"
- 45.25" long pump handle for easy pumping under load
- Dual pump piston power unit raises saddle to maximum height in 8 full incremental pump strokes with no load
- Load-limiting and bypass valves to prevent use beyond rated capacity and over-extension of ram

Warranty information:
2-year warranty.



KTI63133 3.33 Ton Low Profile Service Jack

- 3.33 ton capacity low profile service jack for easy access under low ground clearance vehicles
- Lift range from 3.5" to 21.375"
- 50" long pump handle for easy pumping under load
- Dual pump piston power unit raises saddle to maximum height in 8 full incremental pump strokes with no load
- Load-limiting and bypass valves to prevent use beyond rated capacity and over-extension of ram

Warranty information:
2-year warranty.





KTI63155
5 Ton Service Jack

- 5 ton capacity service jack with a lift range from 5.75" to 22"
- 45.75" long pump handle with release knob works independently of handle position
- Raise the saddle quickly to the load with additional foot pedal
- Load-limiting and bypass valves prevent jack from being used beyond rated capacity and over-extension of ram
- Handle locks in either vertical, 45 degree, or horizontal positions

Warranty information:
 2-year warranty.



KTI63186
10 Ton Service Jack

- 10 ton capacity service jack with a lift range from 6.25" to 22.5"
- 45.75" long pump handle with release knob works independently of handle position
- Raise the saddle quickly to the load with additional foot pedal
- Load-limiting and bypass valves prevent jack from being used beyond rated capacity and over-extension of ram
- Handle locks in either vertical, 45 degree, or horizontal positions

Warranty information:
 2-year warranty.



KTI63194
22 Ton Air Hydraulic Truck Jack

- 22 ton capacity truck jack with a lift range from 8.9" to 17.5"
- Narrow width fits between tandem wheels
- Load-limiting and bypass valves prevent use beyond rated capacity and overextension of ram
- Spring activated self retracting ram
- Release knob at the top of the T-handle works at any handle position

Warranty information:
 2-year warranty.

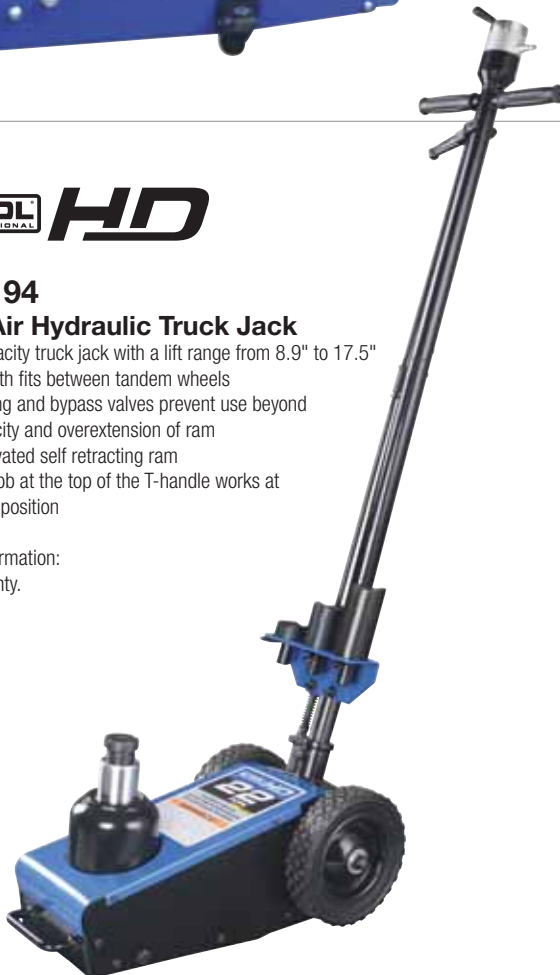

KTI63198
50 Ton Air Hydraulic Truck Jack

- 50 ton capacity truck jack with lift range from 11.4" to 21.25"
- Narrow width fits between tandem wheels
- Load-limiting and bypass valves prevent use beyond rated capacity and over-extension of ram
- Spring activated self-retracting ram
- Release knob at top of T handle works at any handle position

Warranty information:
 2-year warranty.





KTI63131
3 Ton
Compact Service Jack

- Capacity: 3 Tons
- Lifting range: 5.3" - 18.5"
- Sealed hydraulic power unit prevents contaminants from entering system
- Load-limiting and bypass valves prevent use beyond rated capacity and over extension of ram
- Wide track front wheels and rear swivel casters for easy maneuverability

Warranty information:
 1-year warranty.

KTI63103
2 Ton Trolley Jack

- Lifting Capacity: 2 Tons
- Lifting Range: 5.3" to 13.2"
- Lightweight and compact design for easy handling and storage
- Load-limiting and bypass valves prevent against over loading and over extension
- Grab handle for easy positioning and carrying

Warranty information:
 1-year warranty.



KTI63100
1.5 Ton Scissor Jack

- 1.5 ton capacity scissors jack for the tire changing and snow chain installation
- Lifting range from 4.1" to 15.2"
- Large base for added stability
- Long crank handle for ease of turning under load
- All steel construction in a compact design for storage

Warranty information:
 1-year warranty.



KTI63134
Transmission Jack
Adapter for Service Jacks

- Capacity: 700 lbs
- Saddle Forward Tilt: 35°
- Saddle Backward Tilt: 35°
- Easily transforms your service jack into a transmission jack
- Weight: 34.5 lbs

Warranty information:
 2-year warranty.



KTI63136
Fuel Tank Adapter

- Quick and easy installation to all underhoist transmission jack saddles
- Universal adapter plate included for mounting to all other under hoist jack saddles
- Length, width, and height adjustments to handle any fuel tank configuration up to 40 gallon capacity
- Four 3" by 5.5" foam support pads self adjust and protect the tank from damage
- Ground wire assembly can be used with older metal tanks to prevent against static electric discharge

Warranty information:
 2-year warranty.

KTI63500
700 lb Pedestal
Transmission Jack

- Capacity: 700 lbs.
- Hand pumped, long stroke, single stage bottle jack, with a release lever to discharge the load
- Load-limiting and bypass valves prevent against over loading and over extension
- Adaptable saddle, with four angle brackets that can adjust to fit transmission pan flanges
- Adjustable safety chain included to aid in load restraint

Warranty information:
 1-year warranty.



KTI63502
1000 Lb Single Stage
Transmission Jack

- Capacity: 1,000 lbs.
- Lifting Range: 43.625" - 71"
- Saddle tilt: 23 degrees forward and 16 degrees backward
- For automotive use up to light duty pickup trucks
- Foot pedal activation easily raises single ram under load

Warranty information:
 2-year warranty.



KTI63505
1000 Lb. 2-Stage Telescopic
Transmission Jack

- Capacity: 1,000 Lbs
- Lifting Range: 35" to 74.2"
- Speedy pump foot pedal raises telescopic rams to load quickly
- Foot pump and release pedals provide hands free operation to align saddle with transmission
- Four caster wheels for easy transportation and maneuverability

Warranty information:
 2-year warranty.

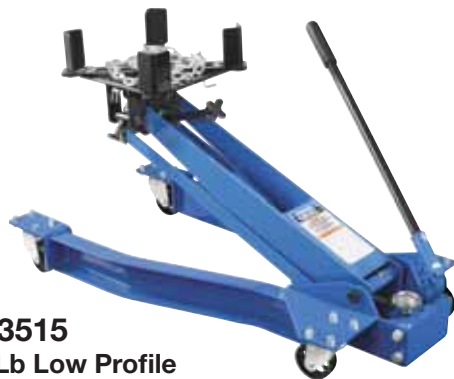

KTI63515
1200 Lb Low Profile
Transmission Jack

- 1200 pound capacity transmission jack with a lift range from 5.75" to 31.5"
- For automotive use up to pickup truck transmissions
- Wide front-open chassis for lower profile when loaded
- Full swivel pump handle can be accessed in any work position
- Fully adjustable universal saddle with load securing hardware

Warranty information:
 2-year warranty.



KTI63517
1.5 Ton Truck
Transmission Jack

- 1.5 ton capacity truck transmission jack with lift range from 8.62" to 36.625"
- Front and back swivel casters allow for trouble-free positioning and maneuverability
- Pump handle rotates 360 degrees for multiple work positions
- Universal saddle with tilt features
- Load restraint system included

Warranty information:
 2-year warranty.





KTI63703 4 Ton Portable Ram Kit - ASP

- 4 ton portable ram kit for spreading, bending, pushing, and clamping applications
- 7,250 PSI hand pump and 10.5" long ram with 4.75" stroke
- Basic attachments, .5 ton spreader ram, and five extension tubes included
- Force gauge to measure force applied to work
- Snap-fit design for quick attachment and tube connections

Warranty information:
2-year warranty.



KTI63709 10 Ton Portable Ram Kit

- 10 ton portable ram kit for spreading, bending, pushing, and clamping applications
- 8,050 PSI hand pump and 12.6" long ram with 5.12" stroke
- Basic attachments, .5 ton spreader ram, and four extension tubes included
- Force gauge to measure force applied to work
- Snap-fit design for quick attachment and tube connections

Warranty information:
2-year warranty.



KTI63716 Air Hydraulic Foot Pump

- 10,000 PSI air/hydraulic foot pump requires 90 PSI air pressure
- Designed to be used with single acting cylinders
- Provides hands free operation for pumping and releasing load
- Usable fluid capacity 98 cubic inches
- Flow rate 42 cu. in. with no load, 8.5 cu. in. with load

Warranty information:
2-year warranty.





KTI63820
1250 Lb Capacity Car Dollies

- Pair of 1250 pound capacity car dollies used to move a disabled vehicle
- Made of steel structural tubing for durability
- Four bearing mounted swivel caster wheels for easy maneuverability
- Two locking caster wheels on each dolly to prevent vehicle from moving
- Weight: 49 lbs

Warranty information:
2-year warranty.



KTI63611
12 Ton Shop Press

- 12 ton capacity shop press made of structural steel channel for added strength
- Pump, 7.1" stroke self-retracting ram and hose with glycerine filled gauge
- Vertical throat opening between 0" to 36.5", 17.75" throat width
- 3.375" opening between movable bolster channels
- 53" frame height, 21.5" width, and 27.5" base leg length

Warranty information:
2-year warranty.



KTI63800
Hand Pallet Jack

High quality welded steel construction and powder-coated finish.

- | | |
|----------------------|-----------|
| Capacity: | 6500 lbs. |
| Max lift height: | 7-1/2" |
| Lowered fork height: | 3" |
| Fork width: | 27" |
| Fork length: | 48" |
| Turning radius: | 210° |
| Weight: | 187 lbs. |



Warranty information:
1-year warranty. Repair or replace at discretion of repair center.

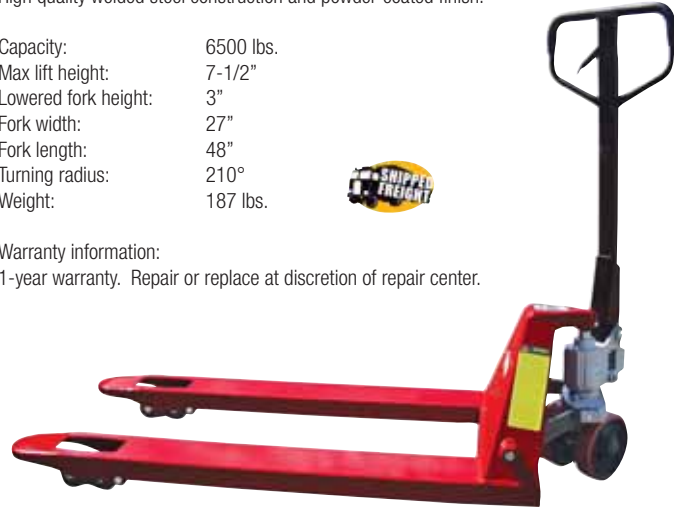

KTI63619
20 Ton Shop Press

- 20 ton capacity shop press made of structural steel channel for added strength
- Pump, 7.28" stroke self-retracting ram and hose with glycerine filled gauge
- Vertical throat opening between 0" to 38", 21.25" throat width
- 4.25" opening between movable bolster channels
- 59.5" frame height, 25.25" width, and 27.5" base leg length

Warranty information:
2-year warranty.





Air Tools, Electric Tools and PBE Tools

Air Tools | Ratchets

1/4" Drive

KT182500A 1/4" Drive Air Ratchet

- 25 ft./lb. ultimate torque
- 250 rpm
- 2 cfm air consumption
- 7" overall length
- 90 PSI air pressure (recommended).



3/8" Drive

KT182503A 3/8" Drive Air Ratchet

- 50 ft./lb. ultimate torque
- 170 rpm
- Designed for reliability and superior performance
- 6 cfm air consumption, 90 PSI air pressure recommended
- 10" overall length



3/8" Drive

KT182504 3/8" Drive Heavy Duty Air Ratchet

- 55 ft./lb. ultimate torque
- Designed for reliability and superior performance
- 170 RPM, 6 cfm air consumption, 90 PSI air pressure recommended
- 11" overall length



AIR RATCHET SPECIFICATIONS

KT182500A	250 rpm	1/4" sq. drive	5-20 ft./lbs. working torque	25 ft./lbs. ultimate torque	7" length	1.00 lb.	2 cfm
KT182503A	170 rpm	3/8" sq. drive	10-60 ft./lbs. working torque	50 ft./lbs. ultimate torque	10" length	2.60 lb.	2 cfm
KT182504	170 rpm	3/8" sq. drive	10-55 ft./lbs. working torque	55 ft./lbs. ultimate torque	11" length	3.00 lb.	6 cfm

Air Tool Warranty Information:

K-Tool International air tools are warranted against defects in workmanship for one (1) year from the date of purchase*. We will repair or replace, at our option, any defective part or unit which proves to be defective in material or workmanship within the warranty period. Should an air tool fail within the first 30 days after purchase date, it may be returned to the place of purchase for a free replacement*. The foregoing obligation is K-Tool International's sole liability under this or any implied warranty, and under no circumstances, shall it be liable for any incidental or consequential damages.

This warranty applies to the basic tool. It does not apply to normal wear and tear on attached accessories/consumable products, such as drill chucks, backing pads for sanders, punch and die for nibblers, air hammer retainers, spray gun cups or "kit" accessories, etc.

*Repairs required as a result of abuse, misuse, damage or repair attempts made by others are not covered by this warranty.

Air Tools, Electric Tools and PBE Tools

Air Tools | Impact Wrenches

3/8"
Drive



KTI81550
Butterfly
3/8" Drive Impact Wrench

The popular Butterfly 3/8" drive with built-in power regulator features instant forward and reverse throttle speed. Streamline design eliminates 2 piece housing construction for excellent power-to-weight ratio.

- 11,000 rpm;
- 3/8" square drive;
- 5-50 ft./lbs. working torque;
- 75 ft/lbs Ultimate Torque
- 3 CFM average air consumption
- Rear exhaust

3/8"
Drive



KTI81560
Pistol Grip
3/8" Drive Impact Wrench

Unlike "nose heavy" pistols, this tool is perfectly balanced.

- 11,000 rpm;
- 3/8" square drive;
- 5-50 ft./lbs. working torque;
- 75 ft./lbs. ultimate torque;
- 5" length; 2.5 lbs.;
- 3 CFM average air consumption

3/8"
Drive



KTI81565
3/8" Drive Air Impact Wrench

- 320 ft./lb. ultimate torque
- 9000 rpm
- 3 cfm air consumption
- 90 PSI air pressure (recommended)

1/2"
Drive



KTI81631A
1/2" Drive Air Impact Wrench

- 450 ft./lb. ultimate torque
- 7500 rpm
- 7 cfm air consumption
- 90 PSI air pressure (recommended)

1/2"
Drive



KTI81622
1/2" Drive
Impact Wrench

Features a full polished tool, reversing trigger, "Rocking Dog" clutch and built-in power regulator. Working torque range of 25-180 ft./lbs. Applications: transmissions, body shops and general repair.

- 260 ft./lb. ultimate torque
- 7000 rpm
- 4 cfm air consumption
- 90 PSI air pressure (recommended)

1/2"
Drive



KTI81632A
1/2" Drive Air Impact
with Extended Anvil

- 450 ft./lb. ultimate torque
- 7500 rpm
- 7 cfm air consumption
- 90 PSI air pressure (recommended)

IMPACT WRENCH SPECIFICATIONS

	RPMs	Sq. Drive	Working Torque	Ultimate Torque	Length	Weight	cfms
KTI81550	11,000	3/8"	5-50 ft./lbs.	75 ft./lbs.	5-1/2" length	2.00 lbs.	3 cfm
KTI81560	11,000	3/8"	5-50 ft./lbs.	75 ft./lbs.	5" length	2.50 lbs.	3 cfm
KTI81565	9,000	3/8"	25-300 ft./lbs.	320 ft./lbs.	8" length	3.0 lbs.	3 cfm
KTI81622	7,000	1/2"	25-180 ft./lbs.	260 ft./lbs.	7" length	5.50 lbs.	4 cfm
KTI81631A	7,500	1/2"	25-350 ft./lbs.	450 ft./lbs.	8" length	6.0 lbs.	7 cfm
KTI81632A	7,500	1/2" - 2" ext	25-300 ft./lbs.	450 ft./lbs.	10" length	5.60 lbs.	7 cfm

Air Tools | Impact Wrenches

3/4" Drive

KT181772A 3/4" Drive High Performance Impact Wrench

With the high torque developing clutch, this tool is perfect for assembly work, maintenance of trucks, buses, RVs, farm machinery and construction equipment.



3/4" Drive

KT181774 3/4" Drive Air Impact Wrench

- 1200 ft./lb. ultimate torque
- 4500 rpm
- 8 cfm air consumption
- 90 PSI air pressure (recommended)



3/4" Drive

KT181775 3/4" Drive Heavy-Duty High Power Impact Wrench

- 900 ft./lb. ultimate torque
- 7000 rpm
- 8 cfm air consumption
- 90 PSI air pressure (recommended)



The ultimate in 3/4" impacts. The big brother to the KT181631 with the high power twin hammer clutch, making this the wrench for all 3/4" applications, including all the hardest jobs, such as springs, tractor pad removal, farm equipment, truck tires, truck suspension and construction equipment.

1" Drive

KT181795 1" Drive Air Impact Wrench with 13 Piece SAE Socket Set

- 1500 ft./lb. ultimate torque
- 3500 rpm
- 8 cfm air consumption
- 90 PSI air pressure (recommended)

KTi's air tools are designed for reliability and superior performance. Includes 13-piece 1" drive short fractional impact socket set including sizes 3/4" to 3" (KTI-35113).



IMPACT WRENCH SPECIFICATIONS

	RPMs	Sq. Drive	Working Torque	Ultimate Torque	Length	Weight	cfms
KT181772A	4,500	3/4"	100-500 ft./lbs.	800 ft./lbs.	11.25" length	11.55 lbs.	5 cfm
KT181774	4,500	3/4"	100-950 ft./lbs.	1200 ft./lbs.	14" length	15 lbs.	8 cfm
KT181775	7,000	3/4"	200-600 ft./lbs.	900 ft./lbs.	15-5/8" length	11.50 lbs.	8 cfm
KT181795	3,500	1"	100-1100 ft./lbs.	1500 ft./lbs.	20" length	55 lbs.	8 cfm

Air Tools, Electric Tools and PBE Tools

Air Tools | Drills

KT184218 3/8" Air Drill

- 2,200 rpm
- 3/8" Keyed Chuck
- Whisper Quiet



Lightweight whisper quiet 3/8" drill, with all ball and needle bearing spindle component support and machined planetary gearing.

KT187130 1/4" Straight Air Drill without Chuck

- 2,500 rpm
- 4 CFM air consumption
- 1/4" air inlet
- 1.9 lbs.



Capacity designed for work in close quarters. Durable, light-weight design.

KT184228 3/8" Reversible Air Drill

- 2,000 rpm
- 3/8" Keyed Chuck
- 4 CFM air consumption
- Handle exhaust
- 3/8"-24 spindle



Features through handle muffled exhaust, controllable speed through the teasing trigger and all ball and needle bearing component support.

KT184229 1/2" Heavy-Duty Reversible Drill

- 800 rpm
- 1/2" Keyed Chuck
- Reversible
- Trigger Speed Control
- Handle exhaust
- 4 CFM air consumption



This 1/2" reversible drill is unsurpassed with its whisper quiet through handle exhaust, controllable speed through the teasing trigger and all ball and needle bearing spindle component support.

DRILL SPECIFICATIONS

KT187130	2,500 rpm	1/4" chuck	3/8" - 24 spindle	6 1/2" length	1.9 lbs.	4 cfm
KT184218	2,200 rpm	3/8" chuck	3/8" - 24 spindle	7 1/2" length	2.25 lbs.	4 cfm
KT184228	2,000 rpm	3/8" chuck	3/8" - 24 spindle	9" length	3.00 lbs.	4 cfm
KT184229	800 rpm	1/2" chuck	3/8" - 24 spindle		4.00 lbs.	4 cfm

Air Tools | Air Hammers



KT183275 Regulated Air Hammer

Features independent power regulators, teasing throttle for operator control, all metal 1-piece housing, hardened alloy steel barrel and standard .401" shank opening.



KT183277 Regulated Long Air Hammer

Extra long barrel provides a harder hitting blow. Also features independent power regulators, teasing throttle for operator control, all metal 1-piece housing, hardened alloy steel barrel and standard .401" shank opening.

AIR HAMMER SPECIFICATIONS

KT183277	2,000 blows per min.	.401" shank	3-1/2" stroke	3/4" bore	9" length	4.00 lbs.	4 cfm
KT183275	3,500 blows per min.	.401" shank	2-5/8" stroke	3/4" bore	6-3/4" length	3.50 lbs.	4 cfm

Air Tools | Die Grinders

KT187132 Rear Exhaust Die Grinder

- 22,000 rpm
- 1/4" collet
- 2 cfm average air consumption



Die grinder features a powerful 1/2 HP motor, built-in power regulator, variable speed throttle control and full ball bearing construction. Standard with 1/4" collet. Specifications: 22,000 rpm; 1/4" collet; 5-1/2" length; 14 oz. weight; 2 cfm average air consumption.

KT187126 Rear Exhaust Angle Die Grinder

- 20,000 rpm
- 1/4" collet
- 3 cfm air consumption



Die grinder features full bearing support air motor, rear exhaust independent power regulator and variable speed throttle. Complete with 1/4" collet. Angle head is full bearing construction with a grease fitting for external lubrication. Specifications: 20,000 rpm; 5-1/2" length; 1/4" collet; 3 cfm air consumption.

KT187125 Mini Rear Exhaust Die Grinder

- 25,000 rpm
- 1/4" collet
- 2 cfm air consumption



Die grinder features full bearing support air motor, rear exhaust independent power regulator and variable speed throttle. Complete with 1/4" collet. Angle head is full bearing construction with a grease fitting for external lubrication. Specifications: 25,000 rpm; 5 1/2" length; 1/4" collet; 2 cfm air consumption.

KT187128 Gearless Angle Die Grinder

- 20,000 rpm
- 1/4" collet
- 4 cfm air consumption



Tool features drop-in motor, rear exhaust and enhanced muffler system. Lightweight, thermally insulated composite housing reduces vibration. Hardened steel cylinder maximizes air utilization. Grinder's 1/4" collet accepts 1/8", 1/4", 3mm and 6mm shanks

DIE GRINDER SPECIFICATIONS

KT187132	22,000 rpm	1/4" collet	5-1/2" length	1.00 lb.	2 cfm
KT187125	25,000 rpm	1/4" collet	5-1/2" length	14 oz.	2 cfm
KT187126	20,000 rpm	1/4" collet	5-1/2" length	14 oz.	3 cfm
KT187128	20,000 rpm	1/4" collet	6-1/4" length	14 oz.	4 cfm

Air Tools | Needle Scalers

KT189275 Needle Scaler Standard Duty

This scaler features 3,500 blows per minute with an extra kick, teasing trigger and independent power regulator.



KT183280 Weld Flux Needle Scaler

This industrial needle scaler converts to a standard scaler in seconds. Simple "J" slot adjustment for needle wear or to provide more needle exposure. Positive lock retainer.

NEEDLE SCALER SPECIFICATIONS

KT189275	3,500 blows per min.	-	2-5/8" stroke	12" length	4.50 lbs.	4 cfm
KT183280	4,600 blows per min.	1/2" square shank	1-1/8" stroke	15" length	6.00 lbs.	5 cfm



KTI88255
Utility / Muffler Cut-off Tool

- 20,000 rpm
- Use with 3" Diameter Abrasive Discs
- Cutting shield

Cuts through muffler clamps, hangers, sheet metal, radiator hose clamps, rusted bumper bolts and steel rods up to 3/4" thick. Standard equipment includes an abrasive 3" disc cutter, independent power regulator, a hand guard trigger and see through cutting shield.



KTI89218
Air Shear Cutter

- Cut up to 180" per minute
- 18 gauge capacity
- 360° head rotation

Pistol grip, through handle exhaust, high speed 180" per minute cutting capacity in 18 gauge sheet metal. This tool features variable speed control, full ball bearing construction and hardened planetary gear system. The shear head can be positioned in any 360° rotation from the handle for ease of work.

Replacement parts:
KTI89220 - Replacement Shear Head Attachment



KTI89110
Air-Draulic
3/16" Rivet Gun

- 4 nose pieces
- Air relief valve

Rugged tool sets rivets up to 3/16" OD. Includes 4 standard-size nose pieces: 3/32", 1/8", 5/32" and 3/16". Air relief prevents overloading and increase life. Side air inlet. Specifications: 75-80 recommended psi; 3/16" capacity; 4.5 cfm average air consumption.



KTI89115
Air-Draulic
1/4" Rivet Gun

- 6 nose pieces
- Includes a separate head assembly for steel rivets up to 3/16"

Rugged tool sets rivets up to 1/4" OD. Includes 6 standard-size nose pieces: 3/32", 1/8", 5/32", 3/16", 7/32", 1/4". Includes complete head assembly (jaws and pusher) for 3/32" through 3/16" steel rivets. Specifications: 75-80 recommended psi; 1/4" capacity; 4.5 lbs.; 4.5 cfm average air consumption.

SPECIFICATIONS

KTI89218	2,800 strokes per min.	18 gauge capacity	8-1/2" length	3.50 lbs.	4 cfm
KTI88255	20,000 rpm	3/4" capacity	8" length	2.05 lbs.	4 cfm
KTI89110	75-80 psi (recommended)	3/16" capacity	10.8 Length	3.25 lbs.	4.5 cfm
KTI89115	75-80 psi (recommended)	1/4" capacity	12.5 Length	4.50 lbs.	4.5 cfm

Air Tools | PBE Tools



KT185800 Dual Piston In-line Sander / File

Sander features a four-cylinder systems. Its double acting pistons constantly work in opposition to each other, resulting in more power and a smoother, more reliable tool. Specifications: 3,000 rpm; 1" stroke; 2-3/4" x 15-3/4" pad; 15-3/4" length; 6.5 lbs.; 6 cfm average air consumption.



KT185746 "Quiet" Dual-Action Sander

Dual-action, quiet sander features built-in speed regulator, variable speed trigger, shielded ball bearing for longer life with smooth harmonics and 6" flexible foam sanding pad with vinyl. Specifications: 10,000 rpm; 6" pad; 8-1/4" length; 4 lbs.; 4 cfm average air consumption.



KT185265 Variable Speed Sander

- 2,000 - 18,000 rpm variable
- 3 Pad sizes included

Variable speed (2,000-18,000) pistol grip 1/2 HP sander features one-piece all metal housing, independent power regulator and teasing trigger. Includes 3", 4" and 5" pads. Ideal for removing paint and rust, shaping filler patches and smoothing welds. Specifications: 18,000 rpm; 6 1/2" length; 3.5 lbs.; 6 cfm average air consumption.



KT185846 High Performance "Quiet" Dual-action Sander

This tool will produce a far superior blending and smoothing of filler, feather edging and pre-paint preparation. Dual-action "quiet" sander has a high efficiency motor and an all steel balancer body and steel spindle lock nut. This balancer is crossbolt-style hub mounting which minimizes vibration.

KT185807 7" Horizontal Air Sander

- 7" diameter pad
- Includes a multiposition handle for a variety of uses and ergonomic comfort
- Designed for reliability and superior performance
- 2800 RPM
- 1/4" NPT air inlet, 7 cfm air consumption
- 90 PSI air pressure recommended.



SPECIFICATIONS

KT185265	18,000 rpm		3", 4" and 5"inch pads	6-1/2" length	3.50 lbs.	6 cfm
KT185746	10,000 rpm		6" pad	8-1/4" length	4.00 lbs.	4 cfm
KT185846	10,000 rpm		6" pad	8-1/4" length	4.00 lbs.	4 cfm
KT185800	3,300 strokes per min.	1" stroke	2-3/4" x 15-3/4" pad	15-3/4" length	6.50 lbs.	6 cfm
KT185807	2,800 rpm		7" pad	16" length	6.00 lbs.	7 cfm

Air Tools, Electric Tools and PBE Tools

Air Tools | PBE Tools



KT180955

Touch-up Paint Gun

Includes plastic cup. For touch up, edging, shading or precision detail painting.



KT189302

Panel Cup Dent Puller

Shops can reduce labor time nearly 50 percent by using this tool, as well as trim the cost of finishing materials. Especially effective in eliminating "oil can" indentations from doors and quarter panels. Body technicians will benefit from the tool's compact design. Weighs only 3-1/4 lbs. and measures only 11" wide. Oval-shaped cup that positions easily in any direction. Non-scratching materials allow the tool to also be used to lift and handle glass.

KT180995

Deluxe Spray Gun

This deluxe spray gun features a siphon feed, external mix, built-in regulator and dripless cup. Gun works with all types of automotive refinishing materials.



KT180998

Deluxe Production Spray Gun

Professional quality gun provides superior atomization of high solid base coats, clear coats, acrylic enamels, acrylic lacquers, and metallic and other coatings. Includes dripless cup.



Electric **Corded Tools**



KT110010
4-1/2" Angle Grinder
650 Watt

- Features a compact design for improved handling
- Spindle lock makes changing the grinder wheel quick and easy
- Grinder also includes a grinding wheel guard, wrench and flange
- Ergonomic, removable side handle adds versatility for any job
- UL listed; One-year limited warranty.

Specifications: 5 amp; 11,000 rpm no-load speed; 120 volt AC rating. A spindle lock makes changing the grinder wheel quick and easy. Grinder also includes a grinding wheel guard, wrench and flange. The ergonomic, removable side handle adds versatility for any job! UL listed. One-year limited warranty.



KT181380
1/2" Electric Impact Wrench

- 7 amp tool features 120 volts, 2100 RPM and double insulation
- Up to 235 ft./lbs. of torque
- Complete with an extra set of easy-change screw in brushes

This heavy-duty 7 amp tool features 120V, 2100 rpm, double insulation and up to 235 ft./lbs. of torque. Packaged with an extra set of easy change screw-in brushes.



KT110210
10" Random Orbit Polisher/Waxer

- 10-inch pad to reduce waxing and polishing time
- For use on cars, RVs, vans, SUVs and boats
- High-impact ABS shell for added durability
- Includes one (1) terry cloth bonnet and one (1) synthetic wool bonnet
- UL listed

Polisher maintains that "new car finish" and protects and restores older finishes. Specifications: 0.75 amp; 3,000 rpm no load speed; 120V/60Hz rated voltage; 10-inch cord.



KT110215
7" Variable Speed Polisher

- 7" Pad
- Variable speeds: 1,000 to 3,000 rpm
- Soft start
- Overload protection and trigger lock

The electric 7" polisher/sander features variable speed control which allows users to set maximum speeds from 1,000 to 3,000rpm for different polishing applications. Polisher boasts a repositionable handle for a variety of jobs. Specifications: 11 amp; 120V/60Hz; variable speeds: 1,000 to 3,000 rpm; soft start; overload protection and trigger lock.

Includes: one (1) 7" rubber polishing pad; one (1) 7" sanding pad and one (1) wool bonnet. UL listed.

Air Tools, Electric Tools and PBE Tools

Air Tools | Hammer Accessories

KT181900 4-Piece Pneumatic Bit Set

Includes panel cutter, cold chisel, hammer bit and scraper.



**LIFETIME
WARRANTY***



(A)



(B)



(C)



(D)

Air Hammer Accessories

KT183091
Bee hive quick-change retainer. (A)

KT183092
One-piece safety bit retainer. (B)

KT183093
Heavy-duty quick-change retainer. (C)

KT183090
Needle scaler attachment. (D)



(A)

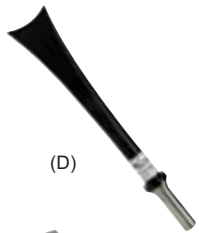

(D)

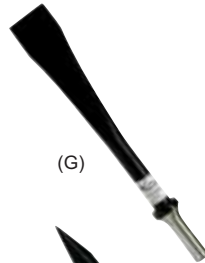

(G)

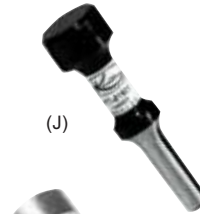

(J)



(M)

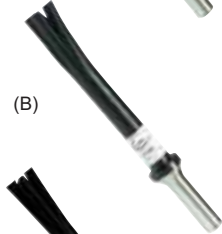

(B)

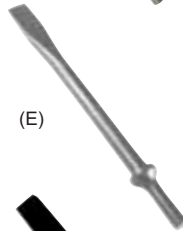

(E)

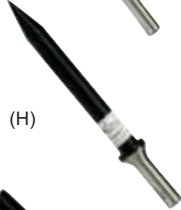

(H)

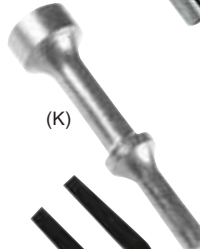

(K)

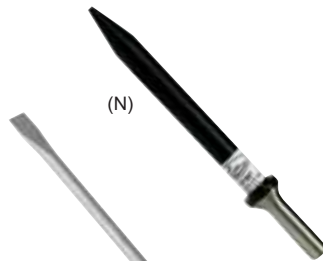

(N)

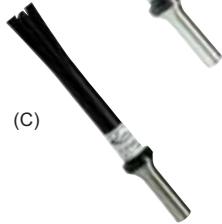

(C)

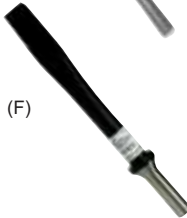

(F)

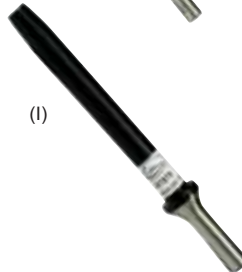

(I)

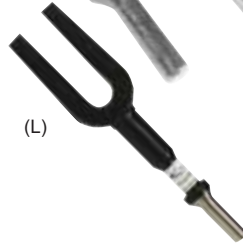

(L)

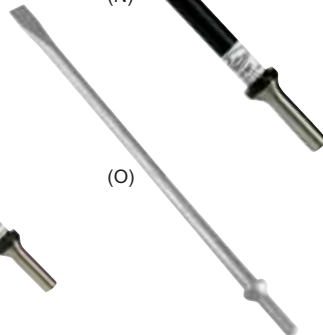

(O)

Pneumatic Bits

- KT181956** Double cut body ripper. (A)
- KT181958** Slotted panel cutter. (B)
- KT181959** Sheet metal trimmer. (C)
- KT181968** Tail pipe cut-off. (D)
- KT181972** 6" cold chisel.
- KT181973** 8" cold chisel.
- KT181974** 10" cold chisel. (E)
- KT181975** Rivet and bolt cutter. (F)
- KT181976** Scraper. (G)
- KT181977** Taper punch sharp point. (H)

**LIFETIME
WARRANTY***

- KT181979** 3/8" taper punch. (I)
- KT181981** Hammer. (J)
- KT181982** Long hammer. (K)
- KT181995** Tie rod separator. (L)
- KT181996** Ball joint separator. (M)
- KT181997** 1/8" taper punch. (N)
- KT181986** 18" cold chisel. (O)

Air Tools **Accessories**

KTI89194
2-pack Spray Gun Filters



Air Regulators

KTI89191
1/4 inch Air Regulator



KTI89193
1/4 inch Air Regulator with Gauge



Air Sander Accessories

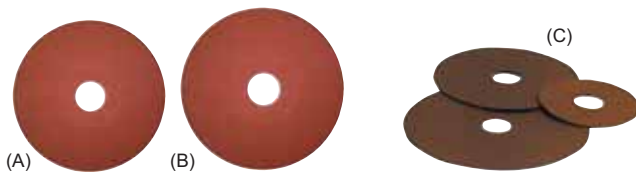

KTI85004
High Speed Sander - 4-1/2" pad (A)

KTI85005
High Speed Sander - 5" pad (B)

KTI85006
3-piece
High Speed Sander Pad Set (3", 4-1/2", 5") (C)

KTI85811
Aluminum Pad Assembly
Jitterbug Sander



KTI85811



KTI80989
Paint Spray Gun Cleaning Kit
Contains all necessary brushes and tools to effectively clean spray guns.
Safe to use with chemicals and solvents.

KTI80996
Dripless Spray Gun Cup



Air Polisher Accessories

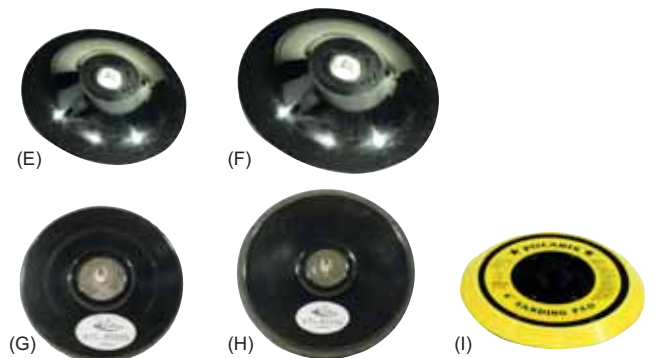

KTI85007
5" Deluxe Phenolic Pad (E)

KTI85008
7" Deluxe Phenolic Pad (F)

KTI85695
5" Dual-Action Bonded Pad. Vinyl face (G)

KTI85696
6" Dual-Action Bonded Pad. Vinyl face (H)

KTI85697
6" Dual-Action Flex Pad. Yellow Vinyl (I)

Air Tools, Electric Tools and PBE Tools



Wire Wheel and Cup Brushes

KTI79200	Crimped wire wheel - narrow face	6" diameter	6,000 max. rpm	1/2" x 5/8" hole center mount
KTI79201	Crimped wire wheel - medium face	6" diameter	6,000 max. rpm	1/2" x 5/8" hole center mount
KTI79205	Crimped wire wheel - wide face	8" diameter	6,000 max. rpm	1/2" x 5/8" hole center mount
KTI79210	Crimped wire cup coarse	1" diameter	4,500 max. rpm	1/4" stem mount
KTI79215	Crimped wire cup coarse	2" diameter	4,500 max. rpm	1/4" stem mount
KTI79216	Crimped wire cup coarse	3" diameter	4,500 max. rpm	1/4" stem mount
KTI79217	Crimped wire wheel coarse	3" diameter	4,500 max. rpm	1/4" stem mount
KTI79220	Knotted wire cup extra-coarse	2 3/4" diameter	12,500 max. rpm	5/8" x 11 thread
KTI79225	Crimped wire cup coarse	3" diameter	12,500 max. rpm	5/8" x 11 thread

Note: Always wear eye protection. Keep loose articles of clothing and jewelry from moving parts.



KTI71303

KTI71306

Abrasive Cut-off Discs

KTI71303
3" x 1/32" cut-off discs - 6 pack

KTI71306
3" x 1/16" cut-off discs - 6 pack

KTI71301
3" x 1/16" cut-off discs - 25 pack

KTI71300
3" x 1/16" cut-off discs - 50 pack

Spindle Adapters

KTI87140
3/8" - 24 ID thread
5/8" - 11 OD thread

KTI87141
10mm - 1.25mm ID thread
5/8" - 11 OD thread



KTI71025
Nylon Recoil Hose

These K-Tool International nylon recoil air hoses will provide your air-operated tools with consistent airflow. They are manufactured from heavy-duty nylon to perform great in all weather conditions. Extends out to 25 ft., but as small as 2 ft. when coiled up.

KTI70013
Cut-off Wheel Arbor

Drill adapter for cut-off discs. Fits any drill with a chuck capacity of 1/4" or larger.



Accessories | Drill Bit Sets



KTI10330 **326-Piece** **Master Drill Bit Set**

KTI's Master Drill Bit is a comprehensive set of drill bits and accessories. This 326-piece set includes bits and accessories for nearly every job. The unique storage case fully opens to access the bit and accessories you need. Two (2) bottom trays fold and slide into portable carrying case. Transport from job to job quickly and easily!

Qty:	Description :	Qty:	Description :
64	HSS Twist Drill Bits: 3/64" (8), 1/16" (8), 5/64" (5), 3/32" (5), 7/64" (5), 1/8" (5), 9/64" (5), 5/32" (5), 3/16" (4), 7/32" (4), 15/64", 1/4", 17/64", 9/32", 5/16", 11/32", 3/8", 7/16", 15/32" and 1/2"	4	Nail Pouch: 1/32", 1/16", 3/32" and 1/8"
54	Titanium Coated High Speed Drill Bits: 3/64" (6), 1/16" (6), 5/64" (4), 3/32" (4), 7/64" (4), 1/8" (4), 9/64" (4), 5/32" (4), 11/64" (4), 3/16" (2), 7/32" (2), 15/64", 1/4", 17/64", 9/32", 5/16", 11/32", 3/8", 7/16", 15/32" and 1/2"	6	Drill Stoppers: 1/8", 5/32", 3/16", 1/4", 5/16" and 3/8"
10	Nutdrivers: 5/32", 3/16", 7/32", 1/4", 9/32", 5/16", 11/32", 3/8", 7/16" and 1/2"	1	Allen Key - 2.5mm
37	2" Screwdriver Bits: 7 Slotted, 6 Phillips, 6 Pozi, 8 Star, 7 Metric Hex and 8 Square	1	Magnetic Holder
64	1" Screwdriver Bits: 14 Slotted, 10 Phillips, 10 Pozi, 8 Star, 7 Hex, 9 Metric Hex and 6 Square	1	Counter Sink
3	14" Masonry Drill Bits: 5/16", 3/8" and 1/2"	1	Gauge
21	Masonry Drill Bits: 5/32" (2), 11/64" (2), 3/16" (2), 7/32" (2), 15/64" (2), 1/4" (2), 17/64", 9/32", 5/16", 21/64", 11/32", 3/8", 7/16", 15/32" and 1/2"	4	Hole Saws: 1-3/4", 2-1/8", 2-3/8" and 2-1/2"
		1	Hole Saw Adapter
		44	Wood Boring Drill Bits: 1/8" (3), 5/32" (4), 11/64" (8), 3/16" (4), 13/64" (4), 7/32" (4), 15/64" (4), 1/4" (4), 17/64", 9/32", 5/16", 11/32", 3/8", 7/16", 15/32" and 1/2"
		5	Flat Wood Bits: 1/2", 5/8", 3/4", 7/8" and 1-1/4"
		4	12" Flat Wood Bits: 5/16", 3/8", 1/2" and 9/16"

KTI71200 **10-Pack Double-Ended Drill Bits**

Double-ended, 2" long bits are made of high-speed steel. Ideal for auto body work and sheet metal drilling.



Air Tools, Electric Tools and PBE Tools

Air Tools | Air Hose

KT172000

Rubber Whip Hose 3/8" x 3'

- 3 Foot length, 3/8" ID
- Solid brass 1/4" NPT male ends, 300 PSI



Whip Hoses with Swivel End

- Red rubber whip hose with brass ferrule
- 1/4" Swivel NPT Male fitting and 1/4" Fixed NPT Male Fitting
- 300 PSI

KT172007 3/8" x 3' Whip Hose, 1/4" Swivel

KT172008 3/8" x 6' Whip Hose, 1/4" Swivel

KT171000

Black Steel Hose Reel With 3/8" x 50 Foot Rubber Air Hose

- All steel constructed black reel with 300 PSI red rubber hose (50 foot)
- Slotted mounting base for easy installation
- Automatic spring powered recoil
- 8 position ratchet gear locks reel at desired hose length
- 3/8" I.D., 1/4" male NPT



Heavy duty, steel construction air hose reel. Reinforced side plates are powder coated to resist corrosion. Comes with 3/8" diameter, 50 ft. rubber air hose which features a 1/4" male NPT, PVC bend restrictor, and brass ferrule. The eight position ratchet gear locks the reel at desired hose length. An automatic spring powered recoil system retracts air hose easily. Multi-direction rollers prevent snagging and reduced wear. The pre-slotted base can be installed trouble-free with 3 positions for installation where convenient (bench, ceiling, floor or wall).

Rubber Air Hose

- High-quality rubber air hose
- Working pressure: 300 psi
- 1/4" NPT
- 3/8" ID
- Made in USA



KT172025 - 25 feet

KT172035 - 35 feet

KT172050 - 50 feet



KT172001

KT172002

KT172003

KT172004



KT172005

KT172006



Rubber Air Hoses

- Rubber air hose with brass ferrule
- Male NPT fittings available in 1/4", 3/8" and 1/2"
- 300 PSI
- PVC Bend Restrictors
- Color: RED

KT172001 3/8" ID x 25' Rubber Air Hose 1/4" NPT Male Fittings

KT172002 3/8" ID x 50' Rubber Air Hose 1/4" NPT Male Fittings

KT172003 1/2" ID x 25' Rubber Air Hose 3/8" NPT Male Fittings

KT172004 1/2" ID x 50' Rubber Air Hose 3/8" NPT Male Fittings

KT172005 1/2" ID x 25' Rubber Air Hose 1/2" NPT Male Fittings

KT172006 1/2" ID x 50' Rubber Air Hose 1/2" NPT Male Fittings



Pro Rubber Air Hoses

- Yellow professional rubber air hose with brass ferrule
- 1/4" NPT Male Fittings
- 300 PSI
- PVC Bend Restrictors
- Color: Yellow

KT172010 3/8" x 25' Pro Rubber Air Hose 1/4" NPT Male Fittings

KT172011 3/8" x 35' Pro Rubber Air Hose 1/4" NPT Male Fittings

KT172012 3/8" x 50' Pro Rubber Air Hose 1/4" NPT Male Fittings

3/8" Heavy Duty Air Hose

- 100% rubber air hose
- Heavy duty, ultra light weight and super strong
- 3/8" ID, 300 PSI, 1/4" NPT fittings with brass ferrules and a bend restrictor to reduce kinking
- Stays flexible in temperatures from -50 degree to 180 degree Fahrenheit
- Ozone and abrasion resistant EPDM blended cover

KT172014

Air Hose 3/8" x 25'

- 3/8" x 25 foot length
- 1/4" NPT fittings

KT172015

Air Hose 3/8" x 50'

- 3/8" x 50 foot length
- 1/4" NPT fittings





Electrical and Hardware Components

Electrical and Hardware Components

Nylon Cable Ties

Hundreds of uses, including electrical, auto, marine, home and garden. Available in black or natural. Many sizes for a variety of applications. Professional quality. Temperature rating: 185° F (85° C). U.S.-made.

	Length	Bundle Diameter	Tensile Strength	Color	Quantity
KTI76040	4"	7/8"	18 lb.	Natural	100
KTI78040	4"	7/8"	18 lb.	Black	100
KTI76070	7"	1-7/8"	50 lb.	Natural	100
KTI78070	7"	1-7/8"	50 lb.	Black	100
KTI77070	7" with mounting head	1-7/8"	50 lb.	Natural	100
KTI76110	11"	31/16"	50 lb.	Natural	100
KTI78110	11"	31/16"	50 lb.	Black	100
KTI76140	14"	4"	50 lb.	Natural	100
KTI78140	14"	4"	50 lb.	Black	100
KTI77140	14" with mounting head	4"	50 lb.	Natural	100
KTI76145	14" heavy-duty	41/16"	120 lb.	Natural	100
KTI78145	14" heavy-duty	41/16"	120 lb.	Black	100
KTI76180	18" heavy-duty	5¼"	120 lb.	Natural	25
KTI78180	18" heavy-duty	5¼"	120 lb.	Black	25
KTI76240	24" heavy-duty	73/16"	175 lb.	Natural	25
KTI78240	24" heavy-duty	73/16"	175 lb.	Black	25
KTI76360	36" heavy-duty	11"	175 lb.	Natural	25
KTI78360	36" heavy-duty	11"	175 lb.	Black	25



Nylon Cable Tie Assortments

Convenient dispenser type package allows access to each compartment separately. Hundreds of uses, including electrical, auto, marine, home and garden. Available in black or natural. Many sizes for a variety of applications. Professional quality. U.S.-made.

KTI76004 (Natural)
KTI78004 (Black)

Each package includes 4" (qty: 200), 7" (qty: 100) and 11" (qty: 100).



KTI76000 Nylon Tie Tightening Tool

Grips nylon cable ties and tightens with very secure grip. Also cuts excess with thumb lever.



KTI50201 Universal Body Clip Plier

These specially designed, patented pliers will remove almost any clip found on trim, bumpers and other areas of the vehicle. The steel levers are enclosed in PMS plastic to prevent scratches. Specially sized and angled tip make these pliers the most versatile clip removal tool. Body clip pliers remove clips found on almost every vehicle - inside and out! Lifetime warranty.



KTI56208

Self Adjusting Wire Stripper

Automatic wire stripper, wire cutter and crimping tool for solderless terminals.

LIFETIME WARRANTY*



KTI56201

9" Professional Multi Purpose Crimper and Wire Stripper

- 9" Length
- Wire cutter, bolt cutter, and wire stripper in one
- Crimps insulated and open barrel terminals



KTI56209

Wire Stripper / Crimper

Can be used as wire stripper, machine screw cutter, wire cutter, insulated crimper or solderless terminal crimper.

LIFETIME WARRANTY*



KTI56202

8.5" Professional Multi Purpose Crimper and Wire Stripper

- 8.5" Length
- Wire cutter, bolt cutter, and wire stripper in one
- Crimps open barrel terminals



KTI56207

9.75" Professional 8-in-1 Quick and Easy Wire Stripper

- 9.75" Length
- Wire cutter, bolt cutter, wire stripper, and bending wire
- Crimps insulated, non-insulated, and pin terminals



KTI56203

Professional Crimping Tool - 0.5/1.5/2.5/4.0/6.0 MM2

- Crimps non-insulated terminals
- Easy to grip handles



KTI71108

Specialty Hose Clamp Pliers

This dual-purpose plier, with side jaw design allows hose clamps to be applied or removed in confined areas. Pincers are held parallel to the hose.

LIFETIME WARRANTY*



KTI56204

Professional Multipurpose Crimping and Wire Stripper - 1.5/2.5/6.0/10/16 MM2

- Crimps non-insulated terminals
- Easy to grip handles



Electrical and Hardware Components



Alligator Clips & Battery Clips

		Qty:
KT10161110 Amp Alligator Clips	1
KT10165130 Amp Battery Clips	1



Battery Terminals

		Qty:
KT102411Battery Terminal Top Mount	1
KT102421Battery Terminal Side Mount Bolt	2
KT102431Battery Terminal Heavy-duty Side Mount	2
KT102441Battery Terminal Heavy-duty Top Mount	2
KT102451Battery Terminal Heavy-duty Top Marine	2
KT102461Side Mount Charging Posts	2
KT102471Side Mount Adapters.....	2
KT102481Side Mount Charging Post Extenders	2
KT102491Side Mount Battery Bolt 3/8"	2
KT102511Top Mount Battery Bolt and Nut 3/8"	2



Dyna Loom - Split Wire Loom

		Length:
KT1027511/2" I.D. Split Wire Loom	7'
KT1027611/4" I.D. Split Wire Loom	10'
KT1027713/4" I.D. Split Wire Loom	5'
KT1027813/8" I.D. Split Wire Loom	10'
KT1027915/8" I.D. Split Wire Loom	6'



Dyna Loom / Routing Clips

		Qty:
KT1027421/4" Wire Loom Clips	10
KT1027433/8" Wire Loom Clips.....	10
KT1027441/2" Wire Loom Clips	10
KT1027455/8" and 3/4" Wire Loom Clips	10



Primary Wire

		Color:	Gauge:	Length:
KTi01912	Primary Wire	Red	10 Gauge	8'
KTi01920	Primary Wire	Black	10 Gauge	8'
KTi01939	Primary Wire	White	10 Gauge	8'
KTi02012	Primary Wire	Red	12 Gauge	10'
KTi02020	Primary Wire	Black	12 Gauge	10'
KTi02039	Primary Wire	White	12 Gauge	10'
KTi02112	Primary Wire	Red	14 Gauge	15'
KTi02127	Primary Wire	Yellow	14 Gauge	15'
KTi02130	Primary Wire	Black	14 Gauge	15'
KTi02149	Primary Wire	White	14 Gauge	25'
KTi02212	Primary Wire	Red	16 Gauge	25'
KTi02227	Primary Wire	Yellow	16 Gauge	25'
KTi02230	Primary Wire	Black	16 Gauge	25'
KTi02249	Primary Wire	White	16 Gauge	25'
KTi02312	Primary Wire	Red	18 Gauge	30'
KTi02327	Primary Wire	Yellow	18 Gauge	30'
KTi02330	Primary Wire	Black	18 Gauge	30'
KTi02349	Primary Wire	White	18 Gauge	30'



Fuse Holders

		Qty:
KTi01641	12 Gauge Fuse Holder for ATO Fuse	1
KTi01661	30 Amp Fuse Holder for AGC Fuse	2



KTi01671 Fuse Puller

Pull Auto, Glass and Mini Fuses

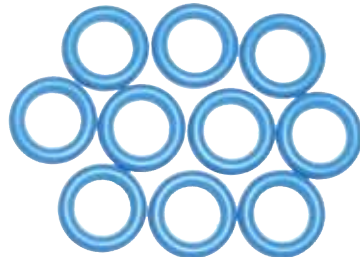

KTi04458 10 Pack Blue A/C O-Rings

Air Conditioning O-Rings (Blue) - Qty 10

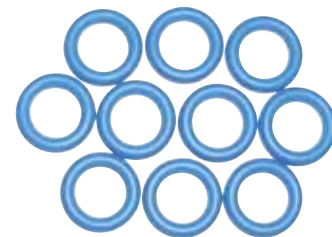

KTi04471 10 PACK BLUE A/C O-RING

Air Conditioning O-Rings Compressor Switch Port/Oil Plug - Quantity 10

Electrical and Hardware Components



ATO Fuses / ATO Glo Fuses

ATO fuses are color coded for amperage, have a recognizable body design, and standard footprint. ATO fuses snap into place without the need for special tools.

	Qty:
KT104209 3 Amp Fuses5
KT104210 5 Amp Fuses5
KT104211 7.5 Amp Fuses5
KT104212 10 Amp Fuses5
KT104213 15 Amp Fuses5
KT104214 20 Amp Fuses5
KT104215 25 Amp Fuses5
KT104216 30 Amp Fuses5
KT104282 10 Amp Glo-Fuse5
KT104283 15 Amp Glo-Fuse5
KT104284 20 Amp Glo-Fuse5
KT104285 25 Amp Glo-Fuse5
KT104286 30 Amp Glo-Fuse5



Mini Fuses / Low Profile Mini Fuses / Glo Mini Fuses

The mini fuse style blade fuse is quickly becoming a new standard in the automotive industry. The mini fuse allows for more circuits to be fused in the same space as either an ATO or ATC style fuse. Mini fuses are offered in 2 to 30 amp current ratings.

	Qty:
KT104199 Fuses Mini 2 Amp5
KT104200 Fuses Mini 3 Amp5
KT104201 Fuses Mini 4 Amp5
KT104202 Fuses Mini 5 Amp5
KT104203 Fuses Mini 7.5 Amp5
KT104204 Fuses Mini 10 Amp5
KT104205 Fuses Mini 15 Amp5
KT104206 Fuses Mini 20 Amp5
KT104207 Fuses Mini 25 Amp5
KT104208 Fuses Mini 30 Amp5
KT104270 Low Profile Mini Fuse - 5 Amp	10
KT104271 Low Profile Mini Fuse - 7.5 Amp	10
KT104272 Low Profile Mini Fuse - 10 Amp	10
KT104273 Low Profile Mini Fuse - 15 Amp	10
KT104274 Low Profile Mini Fuse - 20 Amp	10
KT104275 Low Profile Mini Fuse - 25 Amp	10
KT104276 Low Profile Mini Fuse - 30 Amp	10
KT104277 Mini Glo-Fuse 10 Amp5
KT104278 Mini Glo-Fuse 15 Amp5
KT104279 Mini Glo-Fuse 20 Amp5
KT104280 Mini Glo-Fuse 25 Amp5
KT104281 Mini Glo-Fuse 30 Amp5



Maxi Fuses

		Qty:
KT104234	Fuses Maxi 20 Amp	3
KT104235	Fuses Maxi 30 Amp	3
KT104236	Fuses Maxi 40 Amp	3
KT104237	Fuses Maxi 50 Amp	3
KT104238	Fuses Maxi 60 Amp	3
KT104239	Fuses Maxi 80 Amp	3



Glass Fuses

Although still used in older-model cars, glass fuses are found primarily in automotive accessory applications today. Glass fuses are widely used in electronic and electrical applications where proper fuse selection is critical to performance. Sold as a package of 5.

KT100811	Fuses Glass 10 Amp	5
KT100821	Fuses Glass 15 Amp	5
KT100831	Fuses Glass 20 Amp	5
KT100841	Fuses Glass 25 Amp	5
KT100851	Fuses Glass 30 Amp	5
KT100861	Fuses Glass 5 Amp	5



Jcase Fuses / Low Profile Jcase Fuses

		Qty:
KT104220	Jcase Fuse - 20 Amp	5
KT104221	Jcase Fuse - 30 Amp	5
KT104222	Jcase Fuse - 40 Amp	5
KT104223	Jcase Fuse - 50 Amp	5
KT104224	Jcase Fuse - 60 Amp	5
KT104226	Low Profile Jcase Fuse - 20 Amp	5
KT104227	Low Profile Jcase Fuse - 25 Amp	5
KT104228	Low Profile Jcase Fuse - 30 Amp	5
KT104229	Low Profile Jcase Fuse - 40 Amp	5
KT104230	Low Profile Jcase Fuse - 50 Amp	5
KT104231	Low Profile Jcase Fuse - 60 Amp	5

Electrical and Hardware Components



Electrical Copper Lugs

	Qty:
KT104054Electrical Copper Lugs 1 Gauge x 3/8	10
KT104055Electrical Copper Lugs 1 Gauge x 5/16	10
KT104049Electrical Copper Lugs 2 Gauge x 3/8	10
KT104051Electrical Copper Lugs 2 Gauge x 5/16	10
KT104050Electrical Copper Lugs 4 Gauge x 3/8	10
KT104052Electrical Copper Lugs 4 Gauge x 5/16	10
KT104053Electrical Copper Lugs 6 Gauge x 3/8	10
KT104056Electrical Copper Lugs 6 Gauge x 5/16	10



Electrical Shrink Tube Connectors / Terminals

	Qty:
KT104098Electrical Shrink Tube Butt Connector Heat Shrink 12-10	5
KT104096Electrical Shrink Tube Butt Connector Heat Shrink 16-14	5
KT104094Electrical Shrink Tube Butt Connector Heat Shrink 22-18	5
KT104099Electrical Shrink Tube Butt Connector Solder Seal 12-10	5
KT104097Electrical Shrink Tube Butt Connector Solder Seal 16-14	5
KT104095Electrical Shrink Tube Butt Connector Solder Seal 22-18	5
KT104105Electrical Shrink Tube Female Slide Terminal 12-10 Stud Size .250	5
KT104103Electrical Shrink Tube Female Slide Terminal 16-14 Stud Size .250	5
KT104101Electrical Shrink Tube Female Slide Terminal 22-18 Stud Size .250	5
KT104104Electrical Shrink Tube Male Slide Terminal 12-10 Stud Size .250	5
KT104102Electrical Shrink Tube Male Slide Terminal 16-14 Stud Size .250	5
KT104100Electrical Shrink Tube Male Slide Terminal 22-18 Stud Size .250	5
KT104090Electrical Shrink Tube Ring Terminal 12-10 Stud Size 1/4"	5
KT104089Electrical Shrink Tube Ring Terminal 12-10 Stud Size 10	5
KT104091Electrical Shrink Tube Ring Terminal 12-10 Stud Size 3/8"	5
KT104088Electrical Shrink Tube Ring Terminal 16-14 Stud Size 10	5
KT104087Electrical Shrink Tube Ring Terminal 16-14 Stud Size 6	5
KT104086Electrical Shrink Tube Ring Terminal 22-18 Stud Size 6	5
KT104093Electrical Shrink Tube Spade Terminal 12-10 Stud Size 10	5
KT104092Electrical Shrink Tube Spade Terminal 16-14 Stud Size 10	5



Electrical Solderless Terminals

	Qty:
KT104068	Electrical Solderless Terminals 12-10 #10 Spade10
KT104071	Electrical Solderless Terminals 12-10 Butt Connector10
KT104077	Electrical Solderless Terminals 12-10 Female Disconnect10
KT104109	Electrical Solderless Terminals 12-10 Female Full Insulated Weatherproof5
KT104076	Electrical Solderless Terminals 12-10 Male Disconnect10
KT104108	Electrical Solderless Terminals 12-10 Male Disconnect Full Insulated Weatherproof5
KT104063	Electrical Solderless Terminals 12-10, 1/4" Ring10
KT104064	Electrical Solderless Terminals 12-10, 3/8" Ring10
KT104062	Electrical Solderless Terminals 12-10 #10 Ring10
KT104066	Electrical Solderless Terminals 16-14 #6 Spade10
KT104067	Electrical Solderless Terminals 16-14 #10 Spade10
KT104081	Electrical Solderless Terminals 16-14 2-Way Snap Plug Receptacle10
KT104080	Electrical Solderless Terminals 16-14 3-Way Connector10
KT104070	Electrical Solderless Terminals 16-14 Butt Connector10
KT104075	Electrical Solderless Terminals 16-14 Female Disconnect10
KT104082	Electrical Solderless Terminals 16-14 Female Disconnect for Contact Body10
KT104084	Electrical Solderless Terminals 16-14 Female Disconnect Full Insulated10
KT104106	Electrical Solderless Terminals 16-14 Female Disconnect Full Insulated Weatherproof5
KT104074	Electrical Solderless Terminals 16-14 Male Disconnect10
KT104083	Electrical Solderless Terminals 16-14 Male Disconnect for Contact Body10
KT104085	Electrical Solderless Terminals 16-14 Male Disconnect Full Insulated10
KT104107	Electrical Solderless Terminals 16-14 Male Disconnect Full Insulated Weatherproof5
KT104079	Electrical Solderless Terminals 16-14 Universal Female Snap Plug10
KT104078	Electrical Solderless Terminals 16-14 Universal Snap Plug10
KT104060	Electrical Solderless Terminals 16-14, 1/4 Ring10
KT104061	Electrical Solderless Terminals 16-14, 3/8 Ring10
KT104058	Electrical Solderless Terminals 16-14 #6 Ring10
KT104059	Electrical Solderless Terminals 16-14 #10 Ring10
KT104057	Electrical Solderless Terminals 22-18 #10 Ring10
KT104065	Electrical Solderless Terminals 22-18 #10 Spade10
KT104497	Electrical Solderless Terminals 22-18 #6 Ring10
KT104069	Electrical Solderless Terminals 22-18 Butt Connector10
KT104073	Electrical Solderless Terminals 22-18 Female Disconnect10
KT104072	Electrical Solderless Terminals 22-18 Male Disconnect10



Heat Shrink Tubing

A high quality material which shrinks to 1/3 its size. It can be stored for extended periods of time without shrinkage. It remains flame retardant, and is very flexible. When heated, the sealant flows and physically encapsulates, creating a waterproof barrier.

KT104494	Electrical Shrink Tube 1/2"4
KT102631	Heat Shrink Tubing 1/4" I.D. Length 6"4
KT102611	Heat Shrink Tubing 1/8" I.D. Length 6"4
KT102621	Heat Shrink Tubing 3/16" I.D. Length 6"4
KT102641	Heat Shrink Tubing 3/8" I.D. 6"4
KT102651	Heat Shrink Tubing Assortment8

Electrical and Hardware Components



Vacuum Caps

		Qty:
KT104263	Vacuum Caps 1/4	10
KT104266	Vacuum Caps 1/8	10
KT104262	Vacuum Caps 3/16	10
KT104265	Vacuum Caps 3/8	10
KT104264	Vacuum Caps 5/16	10



Vacuum Tees

		Qty:
KT104260	Vacuum Tees 4-Way 3/16	10
KT104261	Vacuum Tees 5-Way 3/16	10
KT104252	Vacuum Tees 1/4 X 1/4	10
KT104242	Vacuum Tees 1/4-1/4-1/4	10
KT104240	Vacuum Tees 1/8-1/8-1/8	10
KT104251	Vacuum Tees 3/16 X 3/16	10
KT104247	Vacuum Tees 3/16-3/16-1/4	10
KT104241	Vacuum Tees 3/16-3/16-3/16	10
KT104245	Vacuum Tees 3/16-3/16-1/8	10
KT104253	Vacuum Tees 5/16 X 5/16	10
KT104243	Vacuum Tees 5/16-5/16-5/16	10



Grease Fittings

		Qty:
KT104319	Grease Fittings Metric 10MM 45° Elbow	10
KT104320	Grease Fittings Metric 10MM 90° Elbow	10
KT104318	Grease Fittings Metric 10MM Straight	10
KT104313	Grease Fittings Metric 6MM 45° Elbow	10
KT104314	Grease Fittings Metric 6MM 90° Elbow	10
KT104312	Grease Fittings Metric 6MM Straight	10
KT104316	Grease Fittings Metric 8MM 45° Elbow	10
KT104317	Grease Fittings Metric 8MM 90° Elbow	10
KT104315	Grease Fittings Metric 8MM Straight	10
KT104309	Grease Fittings SAE 1/4-28 45° Elbow	10
KT104310	Grease Fittings SAE 1/4-28 90° Elbow	10
KT104311	Grease Fittings SAE 1/4-28 Long Straight	10
KT104308	Grease Fittings SAE 1/4-28 Straight	10



Drain Plug Gaskets

	Qty:
KTi04134 Drain Plug Gasket 1/2 Fiber	10
KTi04135 Drain Plug Gasket 1/2 Nylon	10
KTi04136 Drain Plug Gasket 12mm Poly	10
KTi04137 Drain Plug Gasket 14MM Poly	10
KTi04138 Drain Plug Gasket 16mm Fiber	10
KTi04139 Drain Plug Gasket 18mm Fiber	10
KTi04140 Drain Plug Gasket 20mm Fiber	10
KTi04141 Fiber Gasket 1/2 Double Oversize	10
KTi04142 Drain Plug Gasket 14mm Rubber/Metal	10
KTi04168 Drain Plug Gasket 14mm Fiber	10

Visit www.ktoolinternational.com to download our complete drain plug application guide



Drain Plugs

	Qty:
KTi04120 Oil Drain Plug 12mm x 1.75 (Black Oxide Finish)	5
KTi04121 Oil Drain Plug 12mm x 1.50	5
KTi04123 Oil Drain Plug 14mm x 1.50	5
KTi04124 Oil Drain Plug 12mm x 1.75 (Chrome Finish)	5
KTi04125 Oil Drain Plug - Single Oversize 14mm x 1.50	5
KTi04126 Drain Plug M14-1.50 Pilot Pt	5
KTi04181 Drain Plugs Universal 1/2 Single Oversize	5
KTi04182 Drain Plugs Universal 1/2 Double Oversize	5
KTi04183 Drain Plugs Universal 1/2 Triple Oversize	5
KTi04184 Drain Plugs Universal 1/2 Single Oversize Piggyback	5
KTi04185 Drain Plugs Universal 1/2 Double Oversize Piggyback	5
KTi04188 Drain Plugs 12mm x 1.25 Ford/Infiniti/Lexus/Lexus/Nissan	5
KTi04189 Drain Plugs GM 12mm x 1.75	5
KTi04190 Drain Plugs GM/Ford 14mm x 1.50	5
KTi04193 Drain Plugs Chrysler 1/2-20 with Molded Rubber	5
KTi04195 Drain Plugs GM/Chrysler/Honda/Mazda 14mm DI-Chrome	5
KTi04196 Drain Plugs Ford 14mm x 1.50 Dog Point	5
KTi04198 Drain Plugs GM 12mm x 1.75	5

Visit www.ktoolinternational.com to download our complete drain plug application guide

Electrical and Hardware Components

Brake Line - Copper Nickel / Galfan Coated / PVF Coated

	Qty:
KT103970Brake Line - Copper Nickel 3/16" - 25'	1
KT103971Brake Line - Copper Nickel 1/4" - 25'	1
KT103963Brake Line - Galfan Coated 3/16" x 25' Coil.....	1
KT103964Brake Line - Galfan Coated 1/4" x 25' Coil.....	1
KT103965Brake Line - Galfan Coated 5/16" x 25' Coil.....	1
KT103966Brake Line - Galfan Coated 3/8" x 25' Coil.....	1
KT103967Brake Line - PVF Coated 3/16" x 25' Coil.....	1
KT103968Brake Line - PVF Coated 1/4" x 25' Coil.....	1
KT103969Brake Line - PVF Coated 5/16 x 25' Coil.....	1

Copper-nickel brake lines are easy to bend, corrosion resistant and provide an excellent flare seal.

Galfan coated brake lines provide extended corrosion and abrasion resistance by combining a hot dip coat of the alloy Galfan with an aluminum rich epoxy top coat.

PVF (poly vinyl fluoride) coated lines feature 30X corrosion resistance over plain galvanized lines. PVF coated lines provide significant protection against all road elements.



Brake Line Fittings

	Qty:
KT1040233/16" Brake Line Nut 3/8"-24 Short Thread Inverted Flare	5
KT1040243/16" Brake Line Nut 3/8"-24 Long Thread Inverted Flare.....	5
KT1040251/4" Brake Line Nut 7/16"-24 Short Thread Inverted Flare	5
KT1040261/4" Brake Line Nut 7/16"-24 Long Thread Inverted Flare.....	5
KT1040275/16" Brake Line Nut 1/2"-20 Thread Inverted Flare	5
KT1040083/16" Brake Line Nut Metric 10mm x 1.0 (Jap) Inverted Flare	5
KT1040093/16" Brake Line Nut Metric 10mm x 1.0 (Eur) Bubble Flare	5
KT1040103/16" Brake Line Nut 3/8"-24 (Brit) Bubble Flare.....	5
KT1039723/16" Brake Line Nut Metric 11mm x 1.5 Bubble Flare	5
KT1039733/16" Brake Line Nut Metric 12mm x 1.0 Bubble Flare	5
KT1039743/16" Brake Line Nut Metric 13mm x 1.5 Bubble Flare	5
KT1039753/16" Brake Line Nut 9/16"-18 Inverted Flare	5
KT1039761/4" Brake Line Nut Metric 12mm x 1.0 Bubble Flare	5
KT1039773/16" Brake Line Nut Metric 10mm x 1.0 Long Inverted Flare	5
KT1039783/16" Brake Line Nut Metric 10mm x 1.0 Bubble Flare	5
KT1039793/16" Brake Line Nut 7/16"-24 Inverted Flare	5
KT1039803/16" Brake Line Nut 1/2"-20 Inverted Flare	5
KT1039846mm Brake Line Nut Metric 12mm x 1.0 Bubble Flare.....	5
KT1039856mm Brake Line Nut Metric 14mm x 1.5 Bubble Flare.....	5



Brake Line Adapters

	Qty:
KT104000Brake Master Cylinder Adapter 3/16 Male x 3/16 Female	5
KT104001Brake Metric Adapter 3/16 (3/8"-24) Female Inv Flare x 10mm x 1.0 Male Bubble Flare	5
KT104002Brake Metric Adapter 3/16 (3/8"-24) Female Inv Flare x 10mm x 1.0 Male Inv Flare	5
KT104003Brake Metric Adapter 3/16 (3/8"-24) Female Inv Flare x 11mm x 1.5 Male Bubble Flare	5
KT104004Brake Metric Adapter 3/16 (3/8"-24) Female Inv Flare x 12mm x 1.0 Male Bubble Flare	5
KT104005Brake Metric Adapter 3/16 (3/8"-24) Female Inv Flare x M13 x 1.5 Bubble Inv Flare	5
KT104006Brake Metric Adapter 3/16 (3/8"-24) Female Inv Flare x 10mm x 1.25 Male Bubble Flare	5
KT104011Brake Master Cylinder Adapter 3/16 (3/8"-24) Female x 1/4 (7/16"-24) Male Inv Flare	5
KT104012Brake Master Cylinder Adapter 1/4 (7/16"-24) Female Inv Flare x 3/16 (3/8"-24) Male Inv Flare	5
KT104013Brake Master Cylinder Adapter 1/4 (7/16"-24) Female Inv Flare x 5/16 (1/2"-20) Male Inv Flare	5
KT104014Brake Master Cylinder Adapter 3/16 (9/16"-18) Male Inv Flare x 1/4 Female (7/16"-24) Inv Flare	5
KT104015Brake Master Cylinder Adapter 5/16 (1/2"-20) Male Inv Flare x 3/16 (3/8"-24) Female Inv Flare	5
KT104016Brake Master Cylinder Adapter 3/16 (9/16"-20) Male Inv Flare x 3/16 (3/8"-24) Female Inv Flare	5
KT104017Brake Master Cylinder Adapter 3/16 (9/16"-18) Male Inv Flare x 3/16 (3/8"-24) Female Inv Flare	5
KT104018Brake Master Cylinder Adapter 3/16 (9/16"-18) Male Inv Flare x 3/16 (1/2"-20) Female Inv Flare	5
KT104019Brake Master Cylinder Adapter 1/4 Male x 5/16 Female Inv Flare	5
KT104020Brake Metric Adapter 11mm x 1.5 Male Bubble Flare x 3/16 (10mm x 1.0) Female Inv Flare	5
KT104021Brake Metric Adapter 12mm x 1.0 Male Bubble Flare x 3/16 (10mm x 1.0) Female Inv Flare	5
KT104022Brake Metric Adapter 13mm x 1.5 Male Bubble x 3/16 (10mm x 1.0) Female Inv Flare	5



Brake Line Unions

	Qty:
KT1040293/16" Brake Line Union 3/8"-24 Inverted	5
KT1040301/4" Brake Line Union 7/16"-24 Inverted	5
KT1040315/16" Brake Line Union 1/2"-20 Inverted	5
KT1040073/16" Brake Union British to British Line 3/8"-24 Bubble Flare	5
KT1040283/16" Brake Union Euro to Euro Line M10 x 1.0 Bubble Flare	5
KT1040323/16" Brake Union Japan to Japan Line M10 x 1.0 Inverted Flare	5

Electrical and Hardware Components



Brake Bleeder Screws / Copper Washers

	Qty:
KT104033 Brake Bleeder Screws Ford Truck 3/8-24 Long.....	.5
KT104034 Brake Bleeder Screws GM, Ford, Chrysler Cars 3/8-245
KT104035 Brake Bleeder Screws GM Cars 1/16-245
KT104036 Brake Bleeder Screws GM Cars M10 x 1.05
KT104037 Brake Bleeder Screws Chevy, Chrysler, Import Cars M10 x 1.05
KT104038 Brake Bleeder Screws Ford Truck 7/16-205
KT104039 Brake Bleeder Screw Repair Insert 1/4-18 NPT5
KT104040 Brake Bleeder Copper Washers 29/64 I.D. - 11/16 O.D.5
KT104041 Brake Bleeder Copper Washers 25/64 I.D. - 5/8 O.D.5
KT104042 Brake Bleeder Copper Washers 7/16 I.D. - 13/16 O.D.5



Fuel Line Quick Connect - Straight / 90-degree

	Qty:
KT105100 Fuel Line Quick Connect Straight: Female 1/4 - Male 5/16.....	.5
KT105101 Fuel Line Quick Connect Straight: Female 5/16 - Male 5/16.....	.5
KT105104 Fuel Line Quick Connect Straight: Female 3/8 - Male 5/165
KT105103 Fuel Line Quick Connect Straight: Female 5/16 - Male 3/8.....	.5
KT105202 Fuel Line Quick Connect Straight: Female 5/16 - Male 3/8 Ford OE Style.....	.5
KT105102 Fuel Line Quick Connect Straight: Female 3/8 - Male 3/8.....	.5
KT105124 Fuel Line Quick Connect Posi-Lock Straight Female 5/16 -Male 5/165
KT105125 Fuel Line Quick Connect Posi-Lock Straight Female 3/8 - Male 3/8.....	.5
KT105105 Fuel Line Quick Connect 90-degree: Female 5/16 - Male 5/165
KT105107 Fuel Line Quick Connect 90-degree: Female 3/8 - Male 5/165
KT105108 Fuel Line Quick Connect 90-degree: Female 5/16 - Male 3/85
KT105106 Fuel Line Quick Connect 90-degree: Female 3/8 - Male 3/85
KT105126 Fuel Line Quick Connect Posi-Lock Bent Female 5/16 - Male 5/165
KT105127 Fuel Line Quick Connect Posi-Lock Bent Female 3/8 - Male 3/85



Fuel Line Retainer Clips

	Qty:
KT105375Fuel Line Retainer Clip 3/8" GM.....	10
KT105376Fuel Line Retainer Clip 5/16" GM.....	10
KT105377Fuel Line Retainer Clip 5/16" Ford.....	10
KT105378Fuel Line Retainer Clip 3/8" Ford.....	10
KT105379Fuel Line Retainer Clip 1/4" Ford.....	10
KT105380Fuel Line Retainer Clip 1/2" Ford.....	10
KT105381Fuel Line Retainer Clip 10.5mm Ford Truck.....	10
KT105382Fuel Line Retainer Clip 13mm Ford Truck.....	10
KT105383Fuel Line Retainer Clip 5/16" Ford (White).....	10
KT105384Fuel Line Retainer Clip 3/8" Ford (Black).....	10



Nylon Fuel Line

	Qty:
KT105205Fuel System #12 Rated Nylon Fuel Line 1/4" - 25 Foot Roll.....	1
KT105206Fuel System #12 Rated Nylon Fuel Line 5/16" - 25 Foot Roll.....	1
KT105207Fuel System #12 Rated Nylon Fuel Line 3/8" - 25 Foot Roll.....	1



Fuel Sender Adapters

	Qty:
KT105370Fuel Sender Adapter to Rubber Fuel Line Female 14mm to Male 5/16.....	5
KT105371Fuel Sender Adapter to Rubber Fuel Line Female 16mm to Male 3/8.....	5
KT105226Fuel Sender Adapter to Nylon Fuel Line Female 14mm to Male 5/16.....	5
KT105228Fuel Sender Adapter to Nylon Fuel Line Female 16mm to Male 3/8.....	5

Fuel Line Viton O-Ring



	Qty:
KT105257Fuel Line Viton O-Ring 3/8 GM.....	2
KT105259Fuel Line Viton O-Ring 5/16 GM.....	2

Electrical and Hardware Components



Fuel Line Clamps

	Qty:
KT105118Fuel Line Clamp 360 Degree 1/4 for Nylon & Rubber Hose.....	10
KT105119Fuel Line Clamp 360 Degree 5/16 (8mm) for Nylon & Rubber Hose.....	10
KT105120Fuel Line Clamp 360 Degree 3/8 (10mm) for Nylon & Rubber Hose.....	10
KT105177Fuel System Fuel Injection Hose Clamps 1/4.....	10
KT105179Fuel System Fuel Injection Hose Clamps 5/16 (8mm).....	10
KT105181Fuel System Fuel Injection Hose Clamps 3/8 (10mm).....	10



Fuel Line Fittings

	Qty:
KT105112Brass Compression Union 1/4" Nylon to Nylon.....	5
KT105113Brass Compression Union 5/16" Nylon to Nylon.....	5
KT105114Brass Compression Union 3/8" Nylon to Nylon.....	5
KT105115Brass Compression Union 1/4" Nylon to Steel.....	5
KT105116Brass Compression Union 5/16" Nylon to Steel.....	5
KT105117Brass Compression Union 3/8" Nylon to Steel.....	5
KT105109Nylon Fuel Line Brass Splice Joiner 1/4.....	5
KT105110Nylon Fuel Line Brass Splice Joiner 5/16.....	2
KT105111Nylon Fuel Line Brass Splice Joiner 3/8.....	5
KT105159Nylon Fuel Line Brass Splice Joiner 3/8.....	1
KT105165Fuel System Rubber Hose Barbed Connector 3/16.....	5
KT105167Fuel System Rubber Hose Barbed Connector 1/4.....	5
KT105169Fuel System Rubber Hose Barbed Connector 5/16.....	5
KT105171Fuel System Rubber Hose Barbed Connector 3/8.....	5



Fuel System Adapters

	Qty:
KT105136Fuel System Adapter Steel to Rubber or Nylon Line 1/4.....	5
KT105138Fuel System Adapter Steel to Rubber or Nylon Line 5/16.....	5
KT105141Fuel System Adapter Steel to Rubber or Nylon Line 3/8.....	5
KT105143Fuel System Adapter GM 14mm to 5/16 to Nylon or Rubber Line.....	5
KT105145Fuel System Adapter GM 16mm to 3/8 to Nylon or Rubber Line.....	5
KT105149Fuel System Adapter 3/8 Nylon to 3/8 Rubber.....	5



Fuel Filter Repair Lines

KT105225	Fuel Filter Repair Lines 180 Degree 3/8" x 6-1/2" 16mm GM	Qty: 5
-----------------------	---	-----------



*except KT105372, KT105373 and KT105374



Fuel Filter Line Repair Kits

KT105209	Steel Fuel Line Repair Kit w/14mm Fitting and O-ring 5/16 Line x 9" Length	Qty: 5
KT105211	Steel Fuel Line Repair Kit w/14mm Fitting and O-ring 5/16 Line x 18" Length	5
KT105213	Steel Fuel Line Repair Kit w/14mm Fitting and O-ring 5/16 Line x 30" Length	5
KT105215	Steel Fuel Line Repair Kit w/16mm Fitting and O-ring 3/8 Line x 9" Length	5
KT105217	Steel Fuel Line Repair Kit w/16mm Fitting and O-ring 3/8 Line x 18" Length	5
KT105219	Steel Fuel Line Repair Kit w/16mm Fitting and O-ring 3/8 Line x 30" Length	5
KT105221	Steel Fuel Line Repair Kit w/Quick Disconnect 5/16 x 18 GM/Ford.....	5
KT105372	Nylon Fuel Line Repair Kit Straight 12" Length Female 3/8 x Male 5/16	5
KT105235	Nylon Fuel Line Repair Kit Straight 12" Length Female 3/8 x Male 3/8	5
KT105243	Nylon Fuel Line Repair Kit Straight 12" Length Female 5/16 x Male 5/16	5
KT105233	Nylon Fuel Line Repair Kit Straight 12" Length Female 5/16 x Male 3/8	5
KT105237	Nylon Fuel Line Repair Kit 90 Degree 12" Length Female 3/8 to Male 3/8.....	5
KT105245	Nylon Fuel Line Repair Kit 90 Degree 12" Length Female 5/16 to Male 5/16.....	5
KT105373	Nylon Fuel Line Repair Kit 90 Degree 12" Length Female 3/8 x Male 5/16.....	5
KT105374	Nylon Fuel Line Repair Kit 90 Degree 12" Length Female 5/16 x Male 3/8.....	5
KT105253	Fuel Line Nylon Splice 3/8 Line x 18" Long GM/Ford/Chrysler	5
KT105255	Fuel Line Nylon Splice 5/16 Line x 18" Long GM/Ford/Chrysler	5

KT175300 Fuel Line Quick Disconnect Press Kit

Tool easily attaches fuel line (straight or 90 degree) connectors to OEM nylon fuel lines. Includes four adapters. Features large handle for smooth operation. Can be moved from vehicle to vehicle or bench mounted.



Warranty information:
One-year warranty.

KT175305 Mini Fuel Line Installation Tool

Tool easily attaches all fuel line assemblies to original fuel lines. Includes ratcheting 9/16" wrench. Completely portable, moves from vehicle to vehicle. Designed to fit in tight work areas.



Warranty information:
One-year warranty.

Electrical and Hardware Components

FUSE KITS

Kits are packaged in multicompartment cases; each item is available individually to refill assortments. Please see the following pages for details on the kit contents and how to order components separately.

KT100020 118-piece Master Plug-in Style Fuse Kit
This comprehensive 118-piece assortment contains the most popular 24 numbers of plug-in fuses - ATO, ATM and MAXI.



KT100021 80-piece ATO Fuse Kit
ATO fuse assortment kit includes ten each of eight popular sizes from 3 to 30 amp. ATO fuses are found on most cars, trucks, buses and off-road vehicles. Includes the most popular 8 numbers from 3 amp to 30 amp. Contains 80 pieces.



KT100070 25-piece ATO Glo-Fuse Assortment
Finding open fuses is easy with these fuses that use LED technology to show that a fuse has opened - making them easy to spot in fuse panels tucked up under dark dashboards. Same color coding and amp ratings as the ATO fuses. Includes 25 pieces of the top 5 sizes including 10A, 15A, 20A, 25A and 30A.



KT100028 75-piece Mini Fuse Kit
Mini fuse kit contains 75 total pieces of 10 sizes including 2A, 3A, 4A, 5A, 7.5A, 10A, 15A, 20A, 25A and 30A fuses. ATM mini fuses are used in many late-model OEM applications.



KT100068 30-piece Low Profile Mini Fuse Assortment
This is a low profile version of the ATM mini fuses. Same color code and amp ratings. Includes 30 pieces of the top 6 sizes - 7.5A, 10A, 15A, 20A, 25A and 30A.



KT100069 25-piece ATM Glo-Fuse Assortment
Finding open fuses is easy with these fuses that use LED technology to show that a fuse has opened - making them easy to spot in fuse panels tucked up under dark dashboards. Same color coding and amp ratings as the ATM mini blade fuses. Includes 25 pieces of the top 5 sizes including 10A, 15A, 20A, 25A and 30A.



KT100027 16-piece Maxi Fuse Kit
Maxi fuse kit contains 16 pieces in the most popular 5 sizes including 20A, 30A, 40A, 50A and 60A. Maxi fuses are used to protect circuits in the wiring harness - usually found under the hood, in a fuse panel or supplementary panel near the battery. Primarily used in domestic cars, MAXI fuses also have some applications in imported models. OEM applications currently range up to 60 amps, however, some aftermarket accessories require protection up to 80 amps.



KT100026 10-piece Jcase Fuse Assortment
These high amp fuses are currently on many new domestic and Japanese model vehicles. Same color code and amp ratings. Includes 10 pieces total of the most popular 5 sizes.



KT100045 12-piece Low Profile Jcase Fuse Assortment
This is the low profile version of the JCASE high amp fuses. Same color code and amp ratings. Includes 12 pieces total of the most popular 6 sizes.



KT100067 95-piece AGC Glass Fuse Assortment
These glass tube fuses are used in older-model cars and found primarily in automotive accessory applications. Includes 95 total pieces of 6 popular sizes of AGC, AGW, SFE and GBC type fuses.



See page
168
kit contents



See page
168
kit contents



See page
170
kit contents



See page
169
kit contents



See page
170
kit contents



See page
170
kit contents



See page
168
kit contents



See page
168
kit contents









See page
169
kit contents



See page
170
kit contents

ELECTRICAL KITS

Kits are packaged in multicompartments cases; each item is available individually to refill assortments. Please see the following pages for details on the kit contents and how to order components separately.

- KT100003 100-piece Butt Connector Kit**
 Vinyl solderless butt connector assortment kit includes three popular sizes for use on 10 to 22 gauge wire.
- KT100004 60-piece Butt Connector Kit with Shrink Tube**
 Vinyl butt with shrink fit connector assortment kit includes three popular sizes for use in many applications including automotive and marine. Heat shrink butt connectors make connections weatherproof. Contains 60 pieces.
- KT100035 85-piece Shrink Tube Kit**
 Shrink tube assortment kit includes five popular sizes. Ideal for weathertight seal of all electrical connections. Use for insulating, jacketing, bundling and identification. It is mechanically tough and has good abrasion and solvent resistance. Shrink temp - 250 degrees. Shrink ratio 2:1. Kit contains five sizes (1/8", 3/16", 1/4", 3/8" and 1/2") for a total of 85 pieces.
- KT100037 180-piece Terminal Kit Solderless**
 Solderless terminal kit includes 180 pieces of the most popular terminal rings, spades, male and female disconnects and butt connectors.
- KT100038 120-piece Shrink Tube Solderless Terminal Kit**
 Solderless terminal kit includes 24 popular terminal rings, spades, male and female disconnects, insulated slide terminals and butt connectors. Heat shrink butt connectors make connections weatherproof.
- KT100039 360-piece Professional Terminal Assortment**
 Solderless terminal kit includes 24 of the top terminals including rings, spades, butt connectors, male and female slides, bullet terminals, 2-way and 3-way connectors.
- KT100007 40-piece Copper Lug Terminal Assortment**
 Copper lug terminal assortment kit includes five each of eight popular sized crimp-on copper lugs for use on 1 to 6 gauge wire. Used for large cable applications like battery cables and grounding cables. Contains 40 pieces.



See page
168
kit contents



See page
168
kit contents



See page
169
kit contents



See page
169
kit contents



See page
169
kit contents



See page
169
kit contents



See page
168
kit contents

Electrical and Hardware Components

BRAKE LINE KITS

Kits are packaged in multicompartment cases; each item is available individually to refill assortments. Please see the following pages for details on the kit contents and how to order components separately.

KT100001 27-piece Brake Line Adapter Metric Kit
Metric brake line adapter kit includes an assortment of 27 pieces spanning 9 popular sizes. Used for converting different sized port openings on master cylinders to standard brake systems. All metric sizes.



KT100002 20-piece Master Cylinder Adapter Assortment
Master cylinder adapter kit includes an assortment of 20 pieces spanning 11 popular sizes. Used for converting different sized port openings on master cylinders to standard brake systems.



KT100005 64-piece Brake Line Fitting Kit
This 64-piece assortment contains the 14 most popular numbers of tube nuts and unions. Fittings include applications for US, British, European and Japanese systems.



KT100006 30-piece Brake Bleeder Screw and Washer Asst.
This entry level 30-piece assortment includes the 10 most popular bleed screws and copper washers



KT100047 95-piece Brake Fitting Assortment
Assortment contains a general assortment of tubes nuts, unions and adapters used to make most domestic and import brake lines. Fittings include applications for British, European and Japanese systems.



KT100048 86-piece Master Brake Fitting Assortment
Consists of 20 different types of tubes nuts and unions used to make most domestic and import brake lines. Fittings include applications for British, European and Japanese systems.



KT100049 Brake Line Repair Kit 3/16" 86-piece Master Brake Fitting Assortment plus 25' of 3/16" Copper-Nickel Brake Line
Includes the Master Brake Fitting Assortment (KT100048) which consists of 20 different types of tubes nuts and unions used to make most domestic and import brake lines. It also includes a 25' length of 3/16 copper-nickel brake line.



*except brake line

KT100050 Brake Line Repair Kit 3/16" & 1/4" 86-piece Master Brake Fitting Assortment plus 25' ea. 3/16" and 1/4" Copper-Nickel Brake Line
This kit includes the Master Brake Fitting Assortment (KT100048) which consists of 20 different types of tubes nuts and unions used to make most domestic and import brake lines. It also includes a 25' length of 3/16" and 25' length of 1/4" copper-nickel brake line.



*except brake line



See page
168
kit contents



See page
168
kit contents



See page
169
kit contents



See page
170
kit contents



See page
168
kit contents



See page
168
kit contents



See page
169 & 170
kit contents



See page
170
kit contents

DRAIN PLUG & GASKETS

Kits are packaged in multicompartiment cases; each item is available individually to refill assortments. Please see the following pages for details on the kit contents and how to order components separately.

KT100009 60-piece Drain Plug Gasket Kit Nylon and Fiber



General purpose gasket kit includes the 7 most popular sizes of nylon and fiber gaskets. Contains 60 pieces.



See page
168
kit contents

KT100058 40-piece Drain Plug Assortment



Contains 12 of the most popular drain plugs which provides excellent coverage for most domestic and imported cars and light trucks. Application guide is included. Gaskets sold separately. Drain plug assortments make it easy for any repair shop to keep the most popular drain plugs on hand and organized.



See page
170
kit contents

KT100059 27-piece Drain Plug Assortment



Contains 9 popular oversize drain plugs and gaskets for the repair of stripped drain pan threads. Six sizes including single, double and triple oversize plugs. Includes fiber gaskets. Contains a total of 12 drain plugs and 15 gaskets.



See page
170
kit contents



MISC. FITTINGS

Kits are packaged in multicompartiment cases; each item is available individually to refill assortments. Please see the following pages for details on the kit contents and how to order components separately.

KT100022 50-piece Quick Disconnect Clips



Quick disconnect repair clip assortment kit includes parts for GM, Ford and Chrysler vehicles. Kit contains fuel line retaining clips, transmission line retaining clips and cooling system retaining clips. Packaged in multi-compartment, refillable plastic case. Contains product assortment map for easy identification of components. Made in U.S.A.



See page
168
kit contents

KT100023 60-piece Grease Fitting Kit (SAE)



Grease fitting assortment kit (SAE) includes 1/4-28 sizes. The 1/4-28 thread fitting is used on cars, light trucks and industrial machinery. Requires a tapped hole for installation. Max pressure is 8,000 psi. Kit contains 60 pieces of the top 4 sizes: straight, 45 degree elbow, 90 degree elbow and long straight fittings.



See page
168
kit contents

KT100024 90-piece Grease Fitting Kit (Metric)



Grease fitting assortment kit (metric) includes 6mm, 8mm and 10mm fittings in nine popular sizes. Kit contains straight, 45 degree elbow, and 90 degree elbow fittings. 90 pieces total.



See page
168
kit contents

KT100040 75-piece Vacuum Tee Cap Kit



Small vacuum tee assortment kit includes five popular diameters for capping lines and hoses while testing emission control systems, vacuum lines, etc.. Contains 1/8", 3/16", 1/4", 5/16" and 3/8" diameter caps.



See page
169
kit contents

KT100042 56-piece Vacuum Tee Kit



Entry level vacuum tee assortment includes 13 different sizes of tees. These hard connectors are used with the soft flexible tubing found on today's vehicles. Total of 62 pieces.



See page
169
kit contents

KT104626 88-piece Fuel Line Connector Assortment



This kit contains everything you need to replace fuel line connectors on both steel and nylon line. Assortment includes quick connectors (straight and 90-degree), brass connectors, compression unions, clamps, viton o-rings and connector removal tool.



See page
170
kit contents



KTI00027 16-piece Maxi Fuse Kit		Qty	Refill
KTI04234	20A maxi plug-in fuse	3	10
KTI04235	30A maxi plug-in fuse	4	10
KTI04236	40A maxi plug-in fuse	4	10
KTI04237	50A maxi plug-in fuse	3	10
KTI04238	60A maxi plug-in fuse	2	10

KTI00028 75-piece Mini Fuse Kit		Qty	Refill
KTI04199	2A mini fuse	10	5
KTI04200	3A mini fuse	5	5
KTI04201	4A mini fuse	5	5
KTI04202	5A mini fuse	10	5
KTI04203	7.5A mini fuse	5	5
KTI04204	10A mini fuse	10	5
KTI04205	15A mini fuse	10	5
KTI04206	20A mini fuse	10	5
KTI04207	25A mini fuse	5	5
KTI04208	30A mini fuse	5	5

KTI00035 85-piece Heat Shrink Tube Kit		Qty	Refill
KTI02611	1/8" shrink tube	20	4
KTI02621	3/16" shrink tube	20	4
KTI02631	1/4" shrink tube	30	4
KTI02641	3/8" shrink tube	10	4
KTI04494	1/2" shrink tube	5	4

KTI00037 180-piece Terminal Kit		Qty	Refill
KTI04057	Ring Terminal Wire Size: 22-18 Stud Size: 10	10	10
KTI04058	Ring Terminal Wire Size: 16-14 Stud Size: 6	10	10
KTI04059	Ring Terminal Wire Size: 16-14 Stud Size: 10	10	10
KTI04062	Ring Terminal Wire Size: 12-10 Stud Size: 10	10	10
KTI04063	Ring Terminal Wire Size: 12-10 Stud Size: 1/4	10	10
KTI04065	Spade Terminal Wire Size: 22-18 Stud Size: 10	10	10
KTI04067	Spade Terminal Wire Size: 16-14 Stud Size: 10	10	10
KTI04068	Ring Terminal Wire Size: 12-10 Stud Size: 10	10	10
KTI04069	Butt Connector Wire Size: 22-18	10	10
KTI04070	Butt Connector Wire Size: 16-14	10	10
KTI04071	Butt Connector Wire Size: 12-10	10	10
KTI04072	Male Slide Terminal Wire Size: 22-18 Tab Size: .250	10	10
KTI04073	Female Slide Terminal Wire Size: 22-18 Tab Size: .250	10	10
KTI04074	Male Slide Terminal Wire Size: 16-14 Tab Size: .250	10	10
KTI04075	Female Slide Terminal Wire Size: 16-14 Tab Size: .250	10	10
KTI04076	Male Slide Terminal Wire Size: 12-10 Tab Size: .250	10	10
KTI04077	Female Slide Terminal Wire Size: 12-10 Tab Size: .250	10	10
KTI04497	Ring Terminal Wire Size: 22-18 Stud Size: 6	10	10

KTI00038 120-piece Shrink Tube Terminal Kit Large		Qty	Refill
KTI04086	Ring Terminal 22-18 Stud Size 6	5	NR
KTI04087	Ring Terminal 16-14 Stud Size 6	5	NR
KTI04088	Ring Terminal 16-14 Stud Size 10	5	NR
KTI04089	Ring Terminal 12-10 Stud Size 10	5	NR
KTI04090	Ring Terminal 12-10 Stud Size 1/4"	5	NR
KTI04091	Ring Terminal 12-10 Stud Size 3/8"	5	5
KTI04092	Spade Terminal 16-14 Stud Size 10	5	NR
KTI04093	Spade Terminal 12-10 Stud Size 10	5	NR
KTI04094	Butt Connector Heat Shrink 22-18	5	NR
KTI04095	Butt Connector Solder Seal 22-18	5	5
KTI04096	Butt Connector Heat Shrink 16-14	5	NR
KTI04097	Butt Connector Solder Seal 16-14	5	5
KTI04098	Butt Connector Heat Shrink 12-10	5	NR
KTI04099	Butt Connector Solder Seal 12-10	5	5
KTI04100	Male Slide Terminal 22-18 Stud Size .250	5	NR
KTI04101	Female Slide Terminal 22-18 Stud Size .250	5	NR
KTI04102	Male Slide Terminal 16-14 Stud Size .250	5	NR
KTI04103	Female Slide Terminal 16-14 Stud Size .250	5	NR
KTI04104	Male Slide Terminal 12-10 Stud Size .250	5	NR
KTI04105	Female Slide Terminal 12-10 Stud Size .250	5	NR
KTI04106	Ins. Slide 16-14 Stud Size .250	5	5
KTI04107	Ins. Slide 16-14 Stud Size .250	5	5
KTI04108	Ins. Slide 12-10 Stud Size .250	5	5
KTI04109	Ins. Slide 12-10 Stud Size .250	5	5

KTI00039 360-piece Terminal Kit Large		Qty	Refill
KTI04057	Ring Terminal Wire Size: 22-18 Stud Size: 10	20	10
KTI04058	Ring Terminal Wire Size: 16-14 Stud Size: 6	20	10
KTI04059	Ring Terminal Wire Size: 16-14 Stud Size: 10	20	10

KTI00039 360-piece Terminal Kit Large (cont'd)		Qty	Refill
KTI04060	Ring Terminal Wire Size: 16-14 Stud Size: 1/4	10	10
KTI04061	Ring Terminal Wire Size: 16-14 Stud Size 3/8	10	10
KTI04062	Ring Terminal Wire Size: 12-10 Stud Size: 10	10	10
KTI04063	Ring Terminal Wire Size: 12-10 Stud Size: 1/4	10	10
KTI04064	Ring Terminal Wire Size: 12-10 Stud Size: 3/8	10	10
KTI04066	Spade Terminal Wire Size: 16-14 Stud Size: 6	20	10
KTI04067	Spade Terminal Wire Size: 16-14 Stud Size: 10	20	10
KTI04068	Spade Terminal Wire Size: 12-10 Stud Size: 10	10	10
KTI04069	Butt Connector 22-18	20	10
KTI04070	Butt Connector 16-14	20	10
KTI04071	Butt Connector 12-10	10	10
KTI04074	Male Slide Terminal 16-14 Stud Size .250	20	10
KTI04075	Female Slide Terminal 16-14 Stud Size .250	20	10
KTI04078	Female Bullet 16-14 Stud Size .157	20	10
KTI04079	Male Bullet 16-14 Stud Size .157	10	10
KTI04080	3-Way 16-14	10	10
KTI04081	2-way Female Bullet 16-14 .157	10	10
KTI04082	Female Slide 16-14 Stud Size .250 Brass	20	10
KTI04083	Male Slide 16-14 Stud Size .250 Brass	20	10
KTI04084	Ins. Male Slide 16-14 Stud Size .250	10	10
KTI04085	Ins. Female Slide 16-14 Stud Size .250	10	10

KTI00040 75-piece Vacuum Tee Kit Small		Qty	Refill
KTI04262	Vacuum Cap 3/16"	25	10
KTI04263	Vacuum Cap 1/4"	10	10
KTI04264	Vacuum Cap 5/16"	5	10
KTI04265	Vacuum Cap 3/8"	5	10
KTI04266	Vacuum Cap 1/8"	25	10

KTI00042 56-piece Vacuum Tee Kit Small		Qty	Refill
KTI04240	Vacuum Tee 1/8"x 1/8"x 1/8"	5	10
KTI04241	Vacuum Tee 3/16"x 3/16"x 3/16"	5	10
KTI04242	Vacuum Tee 1/4"x 1/4"x 1/4"	4	10
KTI04243	Vacuum Tee 5/16"x 5/16"x 5/16"	3	10
KTI04245	Vacuum Tee 3/16"x 3/16"x 1/8"	5	10
KTI04247	Vacuum Tee 3/16"x 3/16"x 1/4"	4	10
KTI04251	Vacuum Connector 3/16"	5	10
KTI04252	Vacuum Connector 1/4"	5	10
KTI04253	Vacuum Connector 5/16"	5	10
KTI04260	Vacuum Tee 4-Way 3/16"	5	10
KTI04261	Vacuum Tee 5-Way 3/16"	5	10
KTI04262	Vacuum Cap 3/16"	5	10
KTI04263	Vacuum Cap 1/4"	5	10

KTI00045 12-piece Low Profile JCase Fuse Assortment		Qty	Refill
KTI04226	Low Profile Jcase Fuse - 20 Amp	2	5
KTI04227	Low Profile Jcase Fuse - 25 Amp	2	5
KTI04228	Low Profile Jcase Fuse - 30 Amp	2	5
KTI04229	Low Profile Jcase Fuse - 40 Amp	2	5
KTI04230	Low Profile Jcase Fuse - 50 Amp	2	5
KTI04231	Low Profile Jcase Fuse - 60 Amp	2	5

KTI00047 95-piece Brake Fitting Assortment		Qty	Refill
KTI04000	Adapter 3/8-24 Inv to 3/8-24 Bub.	5	5
KTI04001	Adapter 3/8-24 Inv to M10x1.0 Bub.	5	5
KTI04007	Metric Brake Union Nut 3/16 x 3/8"-24 for 7802 Nut	5	5
KTI04008	Metric Brake Line Nut (Japanese) 3/16 x 10mm x 1.0 Standard Flare	5	5
KTI04009	Metric Brake Line Nut (European) 3/16 x 10mm x 1.0 Bubble Flare	5	5
KTI04010	Metric Brake Line Nut (British) 3/16 x 3/8"-24 Bubble Flare	5	5
KTI04011	Adapter 3/8-24 Inv to 7/16-24 Inv	5	5
KTI04013	Adapter 7/16-24 Inv to 1/2-20 Inv	5	5
KTI04014	Adapter 7/16-24 Inv to 9/16-18 Inv	5	5
KTI04015	Adapter 3/8-24 Inv to 1/2-20 Inv	5	5
KTI04016	Adapter 3/8-24 Inv to 9/16-20 Inv	5	5
KTI04023	Brake Line Tube Nut 3/16 x 3/8-24 Inv	5	5
KTI04024	Brake Line Tube Nut - Long 3/16 x 3/8-24 Inv	5	5
KTI04025	Brake Line Tube Nut 1/4 x 7/16-24 Inv	5	5
KTI04026	Brake Line Tube Nut - Long 1/4 x 7/16-24 Inv	5	5
KTI04028	Metric Brake Union Nut (European) 3/16 x 10mm x 1.0 Bubble Flare	5	5
KTI04029	Brake Line Union 3/16 x 3/8-24 Inv	5	5
KTI04030	Brake Line Union 1/4 x 7/16	5	5
KTI04032	Metric Brake Union Nut (Japanese) 3/16 x 10mm x 1.0 Inv	5	5

Electrical and Hardware Components

KTI00048 86-piece Master Brake Fitting Assortment Qty Refill

KTI03972	Tube Nut 3/16 x M11 x 1.5 Bub	4	5
KTI03973	Tube Nut 3/16 x M12 x 1.0 Bub	4	5
KTI03974	Tube Nut 3/16 x M13 x 1.5 Bub	4	5
KTI03975	Tube Nut 3/16 x 9/16-18 Inv	4	5
KTI03976	Tube Nut 1/4 x M12 x 1.0 Bub	4	5
KTI03977	Tube Nut 3/16 x M10 x 1.0 Inv	4	5
KTI03978	Tube Nut 3/16 x M10 x 1.0 Bub	4	5
KTI03979	Tube Nut 3/16 x 7/16-24 Inv	4	5
KTI03980	Tube Nut 3/16 x 1/2-20 Inv	4	5
KTI03984	Tube Nut 6mm x M12 x 1.0 Bub	4	5
KTI03985	Tube Nut 6mm x M14 x 1.5 Bub	4	5
KTI04008	Metric Brake Line Nut (Japanese) 3/16 x 10mm x 1.0 Standard Flare	5	5
KTI04009	Metric Brake Line Nut (European) 3/16 x 10mm x 1.0 Bubble Flare	5	5
KTI04010	Metric Brake Line Nut (British) 3/16 x 3/8"-24 Bubble Flare	5	5
KTI04023	Brake Line Tube Nut 3/16 x 3/8-24 Inv	5	5
KTI04024	Brake Line Tube Nut - Long 3/16 x 3/8-24 Inv	5	5
KTI04025	Brake Line Tube Nut 1/4 x 7/16-24 Inv	5	5
KTI04026	Brake Line Tube Nut - Long 1/4 x 7/16-24 Inv	5	5
KTI04028	Metric Brake Union Nut (European) 3/16 x 10mm x 1.0 Bubble Flare	5	5
KTI04032	Metric Brake Union Nut (Japanese) 3/16 x 10mm x 1.0 Inv	5	5

KTI00049 86-piece Master Brake Fitting Assortment with 25' length 3/16" Copper-Nickel Brake Line Qty Refill

KTI03970	25' coil of 3/16" copper-nickel brake line	1	1
KTI03972	Tube Nut 3/16 x M11 x 1.5 Bub	4	5
KTI03973	Tube Nut 3/16 x M12 x 1.0 Bub	4	5
KTI03974	Tube Nut 3/16 x M13 x 1.5 Bub	4	5
KTI03975	Tube Nut 3/16 x 9/16-18 Inv	4	5
KTI03976	Tube Nut 1/4 x M12 x 1.0 Bub	4	5
KTI03977	Tube Nut 3/16 x M10 x 1.0 Inv	4	5
KTI03978	Tube Nut 3/16 x M10 x 1.0 Bub	4	5
KTI03979	Tube Nut 3/16 x 7/16-24 Inv	4	5
KTI03980	Tube Nut 3/16 x 1/2-20 Inv	4	5
KTI03984	Tube Nut 6mm x M12 x 1.0 Bub	4	5
KTI03985	Tube Nut 6mm x M14 x 1.5 Bub	4	5
KTI04008	Metric Brake Line Nut (Japanese) 3/16 x 10mm x 1.0 Standard Flare	5	5
KTI04009	Metric Brake Line Nut (European) 3/16 x 10mm x 1.0 Bubble Flare	5	5
KTI04010	Metric Brake Line Nut (British) 3/16 x 3/8"-24 Bubble Flare	5	5
KTI04023	Brake Line Tube Nut 3/16 x 3/8-24 Inv	5	5
KTI04024	Brake Line Tube Nut - Long 3/16 x 3/8-24 Inv	5	5
KTI04025	Brake Line Tube Nut 1/4 x 7/16-24 Inv	5	5
KTI04026	Brake Line Tube Nut - Long 1/4 x 7/16-24 Inv	5	5
KTI04028	Metric Brake Union Nut (European) 3/16 x 10mm x 1.0 Bubble Flare	5	5
KTI04032	Metric Brake Union Nut (Japanese) 3/16 x 10mm x 1.0 Inv	5	5

KTI00050 86-piece Master Brake Fitting Assortment with 25' each 1/4" and 3/16" Copper-Nickel Brake Line Qty Refill

KTI03970	25' coil of 1/4" copper-nickel brake line	1	1
KTI03971	25' coil of 3/16" copper-nickel brake line	1	1
KTI03972	Tube Nut 3/16 x M11 x 1.5 Bub	4	5
KTI03973	Tube Nut 3/16 x M12 x 1.0 Bub	4	5
KTI03974	Tube Nut 3/16 x M13 x 1.5 Bub	4	5
KTI03975	Tube Nut 3/16 x 9/16-18 Inv	4	5
KTI03976	Tube Nut 1/4 x M12 x 1.0 Bub	4	5
KTI03977	Tube Nut 3/16 x M10 x 1.0 Inv	4	5
KTI03978	Tube Nut 3/16 x M10 x 1.0 Bub	4	5
KTI03979	Tube Nut 3/16 x 7/16-24 Inv	4	5
KTI03980	Tube Nut 3/16 x 1/2-20 Inv	4	5
KTI03984	Tube Nut 6mm x M12 x 1.0 Bub	4	5
KTI03985	Tube Nut 6mm x M14 x 1.5 Bub	4	5
KTI04008	Metric Brake Line Nut (Japanese) 3/16 x 10mm x 1.0 Standard Flare	5	5
KTI04009	Metric Brake Line Nut (European) 3/16 x 10mm x 1.0 Bubble Flare	5	5
KTI04010	Metric Brake Line Nut (British) 3/16 x 3/8"-24 Bubble Flare	5	5
KTI04023	Brake Line Tube Nut 3/16 x 3/8-24 Inv	5	5
KTI04024	Brake Line Tube Nut - Long 3/16 x 3/8-24 Inv	5	5
KTI04025	Brake Line Tube Nut 1/4 x 7/16-24 Inv	5	5
KTI04026	Brake Line Tube Nut - Long 1/4 x 7/16-24 Inv	5	5
KTI04028	Metric Brake Union Nut (European) 3/16 x 10mm x 1.0 Bubble Flare	5	5
KTI04032	Metric Brake Union Nut (Japanese) 3/16 x 10mm x 1.0 Inv	5	5

KTI00058 40-piece Automotive Drain Plug Assortment Qty Refill

KTI04120	Drain Plug 12mm-1.75 Pilot Point with Gasket	3	5
KTI04121	Drain Plug 14mm-1.50 Pilot Point with Gasket	3	5
KTI04123	Drain Plug 14mm-1.50 Pilot Point with Gasket	5	5
KTI04124	Drain Plug 12mm-1.75 Pilot Point with Gasket	3	5
KTI04126	Drain Plug 14mm-1.50 Pilot Point with Gasket	3	5

KTI00058 40-piece Automotive Drain Plug Assortment (cont'd) Qty Refill

KTI04188	Drain Plug 12mm-1.25 Standard Zinc	3	5
KTI04189	Drain Plug 12mm-1.75 Pilot Point	3	5
KTI04190	Drain Plug 14mm-1.50 Standard Zinc	3	5
KTI04193	Drain Plug 1/2-20 Pilot Point with Gasket	3	5
KTI04195	Drain Plug 14mm-1.50 Standard Zinc	3	5
KTI04196	Drain Plug 14mm-1.50 Pilot Point	3	5
KTI04198	Drain Plug 12mm-1.75 Pilot Point with Gasket	3	5

KTI00059 27-piece Oversize Drain Plug & Gasket Assortment Qty Refill

KTI04125	Drain Plug M14-1.50 Single Oversize	2	5
KTI04141	Fiber Gasket 1/2" Double Oversize	5	10
KTI04142	Fiber Gasket 1/2" Single Oversize	5	10
KTI04168	Fiber Gasket M14	5	10
KTI04181	Drain Plug 1/2-20 Single Oversize	2	5
KTI04182	Drain Plug 1/2-20 Double Oversize	2	5
KTI04183	Drain Plug 1/2-20 Triple Oversize	2	5
KTI04184	Drain Plug 1/2-20 Single Oversize Piggyback	2	5
KTI04185	Drain Plug 1/2-20 Double Oversize Piggyback	2	5

KTI00067 95-piece AGC Glass Fuse Assortment Qty Refill

KTI00811	10A glass fuse	10	5
KTI00821	15A glass fuse	20	5
KTI00831	20A glass fuse	20	5
KTI00841	25A glass fuse	20	5
KTI00851	30A glass fuse	20	5
KTI00861	5A glass fuse	5	5

KTI00068 30-piece Low Profile Mini Fuse Assortment Qty Refill

KTI04270	Low Profile Mini Fuse - 5 Amp	NA	10
KTI04271	Low Profile Mini Fuse - 7.5 Amp	5	10
KTI04272	Low Profile Mini Fuse - 10 Amp	5	10
KTI04273	Low Profile Mini Fuse - 15 Amp	5	10
KTI04274	Low Profile Mini Fuse - 20 Amp	5	10
KTI04275	Low Profile Mini Fuse - 25 Amp	5	10
KTI04276	Low Profile Mini Fuse - 30 Amp	5	10

KTI00069 25-piece ATM Glo Fuse Assortment Qty Refill

KTI04277	ATM Glo-Fuse 10 Amp	5	5
KTI04278	ATM Glo-Fuse 15 Amp	5	5
KTI04279	ATM Glo-Fuse 20 Amp	5	5
KTI04280	ATM Glo-Fuse 25 Amp	5	5
KTI04281	ATM Glo-Fuse 30 Amp	5	5

KTI00070 25-piece ATO Glo Fuse Assortment Qty Refill

KTI04282	ATO Glo-Fuse 10 Amp	5	5
KTI04283	ATO Glo-Fuse 15 Amp	5	5
KTI04284	ATO Glo-Fuse 20 Amp	5	5
KTI04285	ATO Glo-Fuse 25 Amp	5	5
KTI04286	ATO Glo-Fuse 30 Amp	5	5

KTI04626 88-piece Fuel Line Connector Assortment Qty Refill

KTI05100	Fuel Line Quick Connect Straight: F1/4 - M5/16	2	5
KTI05101	Fuel Line Quick Connect Straight: F5/16 - M5/16	2	5
KTI05102	Fuel Line Quick Connect Straight: F3/8 - M3/8	2	5
KTI05103	Fuel Line Quick Connect Straight: F5/16 - M3/8	2	5
KTI05104	Fuel Line Quick Connect Straight: F3/8 - M5/16	2	5
KTI05105	Fuel Line Quick Connect 90 Degree: F5/16 - M5/16	2	5
KTI05106	Fuel Line Quick Connect 90 Degree: F3/8 - M3/8	2	5
KTI05107	Fuel Line Quick Connect 90 Degree: F3/8 - M5/16	2	5
KTI05108	Fuel Line Quick Connect 90 Degree: F5/16 - M3/8	2	5
KTI05109	Fuel Line Connector Brass 1/4"	2	5
KTI05110	Fuel Line Connector Brass 5/16"	5	5
KTI05111	Fuel Line Connector Brass 3/8"	5	5
KTI05112	Brass Compression Union 1/4" Nylon to Nylon	2	5
KTI05113	Brass Compression Union 5/16" Nylon to Nylon	2	5
KTI05114	Brass Compression Union 3/8" Nylon to Nylon	2	5
KTI05115	Brass Compression Union 1/4" Nylon to Steel	2	5
KTI05116	Brass Compression Union 5/16" Nylon to Steel	2	5
KTI05117	Brass Compression Union 3/8" Nylon to Steel	2	5
KTI05118	Fuel Line Clamp 360 Degree 1/4"	5	10
KTI05119	Fuel Line Clamp 360 Degree 5/16"	10	10
KTI05120	Fuel Line Clamp 360 Degree 3/8"	10	10
KTI05257	Fuel Line Viton O-ring 3/8"	10	10
KTI05259	Fuel Line Viton O-ring 5/16"	10	10
KTI05186	Fuel System Connector Removal Tool 3/8" and 5/16"	1	5

KITS

Hardware kits are packaged in multicompartment cases, but do not have individual pieces available for refill. Contains product assortment map for easy identification of components.

KT100071

150-piece Hitch Pin Assortment

Assortment includes 150 hitch pins in six popular sizes from 5/32" x 2-5/8" to 3/32" x 1-3/16". Manufactured with chrome plated spring steel.



Description	Qty:	Description	Qty:
5/32" x 2-15/16"	8	5/64" x 1-9/16"	25
9/64" x 1-3/4"	20	5/64" x 1-15/16"	30
7/64" x 1-5/8"	25	3/32" x 1-3/16"	42

KT100072

300-piece E-clip Assortment

Assortment includes 300 pieces in 9 sizes from 1/16" to 7/8".



Description	Qty:	Description	Qty:
1/16"	30	1/2"	40
1/8"	30	5/8"	40
3/16"	40	3/4"	40
1/4"	50	7/8"	40
3/8"	50		

KT100074

110-piece Hydraulic Grease Fitting Assortment Fractional

110-piece hydraulic grease fitting assortment kit includes six popular sizes from 1/4"-28 to 1/8"-27. Kit contains straight and 45 degree and 90 degree angled fittings.



Description	Qty:	Description	Qty:
1/4"-28	30	1/8"-27 (90°)	15
1/4"-28 (45°)	15	1/8"-27 (45°)	15
1/4"-28 (90°)	15	1/8"-27	20

KT100075

555-piece Cotter Pin Assortment

Assortment kit includes six popular sizes from 1/16" x 1" to 5/32" x 2-1/2".



Description	Qty:	Description	Qty:
1/16" x 1"	150	1/8" x 1-1/4"	75
3/32" x 1"	150	1/8" x 2"	50
3/32" x 1-1/2"	100	5/32" x 2-1/2"	30

KT100078

144-piece Cotter Pin Assortment

Assortment kit includes six popular products in six different sizes, ranging from 1/8" x 2" to 5/16" x 2-1/2".



Description	Qty:	Description	Qty:
1/8" x 2"	50	1/4" x 2"	20
5/32" x 2-1/2"	30	1/4" x 3"	16
3/16" x 3"	20	5/16" x 2-1/2"	8

KT100077

300-piece Snap Ring Assortment (18 different sizes)

Assortment kit includes 300 pieces of six popular products in 18 different sizes, ranging from 1/8" to 1-1/16".



Description	Qty:	Description	Qty:
1/8"	20	1/2"	25
5/32"	10	1-1/8"	10
3/16"	15	9/16"	15
1/4"	25	5/8"	20
5/16"	15	3/4"	25
3/8"	20	13/16"	15
7/16"	15	7/8"	20
1-1/4"	5	1"	15
15/32"	15	1-1/16"	15

KT100022

Retainer Clip

Quick Disconnect Kit - 60 Piece

60-piece quick disconnect repair clip assortment kit includes parts for GM, Ford and Chrysler vehicles. Made in U.S.A.



Description	Qty:	Description	Qty:
GM/Chrysler/Ford 3/8"	5	Chrysler 5/16"	5
GM/Chrysler/Ford 5/16"	5	Ford 1/2"	5
Ford 5/16"	5	Ford 10.5mm	5
Ford 3/8"	5	Ford 13mm	5
Ford 1/4"	5	GM/Ford 5/8"	5
Ford 5/16"	5	GM 3/4"	5

KT104627

Fuel Line Assortment With OEM

83-piece fuel line connector kit includes 24 different products for Ford, Chrysler and GM vehicles.



Description	Qty:	Description	Qty:
Ford F1/4" M5/16"	2	All Vehicles Size 1/4"	2
GM/Chrysler/Ford F5/16" M5/16"	3	All Vehicles Size 5/16"	2
GM/Chrysler/Ford F3/8" M3/8"	3	All Vehicles Size 3/8"	2
Ford F5/16" M3/8"	2	All Vehicles Size 1/4"	2
GM/Chrysler/Ford F1/4" M5/16"	2	All Vehicles Size 5/16"	2
GM/Chrysler/Ford F3/8" M5/16"	2	All Vehicles Size 3/8"	2
GM/Chrysler/Ford F5/16" M5/16"	3	All Vehicles Size 1/4"	2
GM/Chrysler/Ford 3/8" M5/16"	2	All Vehicles Size 5/16"	2
GM/Chrysler/Ford F1/4" M3/8"	2	All Vehicles Size 3/8"	2
All Vehicles Size 1/4"	2	GM Size 5/16"	2
All Vehicles Size 5/16"	5	GM Size 3/8"	10
All Vehicles Size 3/8"	5	All Vehicles Size 5/16" & 3/8"	1

Electrical and Hardware Components

KITS

Hardware kits are packaged in multicompartiment cases, but do not have individual pieces available for refill. Contains product assortment map for easy identification of components.

KT100080 120-piece Auto Fuse Assortment (color-coded fuses)

120-piece assortment kit includes auto fuses sized from 5A to 30A.



Description	Qty:	Description	Qty:
5A Auto Fuses	20	20A Auto Fuses	20
10A Auto Fuses	20	25A Auto Fuses	20
15A Auto Fuses	20	30A Auto Fuses	20

KT100081 120-piece Mini Auto Fuse Assortment (color-coded fuses)

120-piece assortment kit includes mini fuses sized from 2A to 30A.



Description	Qty:	Description	Qty:
5A Auto Fuses	20	20A Auto Fuses	20
10A Auto Fuses	20	25A Auto Fuses	20
15A Auto Fuses	20	30A Auto Fuses	20

KT100082 56-piece Maxi Auto Fuse Assortment (color-coded fuses)

56-piece assortment kit includes maxi fuses sized from 20A to 100A.



Description	Qty:	Description	Qty:
20A Auto Fuses	7	60A Auto Fuses	7
30A Auto Fuses	7	70A Auto Fuses	7
40A Auto Fuses	7	80A Auto Fuses	7
50A Auto Fuses	7	100A Auto Fuses	7

KT100085 200-piece Hex Washer Drill Assortment

200-piece hex head washer drill assortment kit includes eight popular sizes, ranging from #8 to #10.

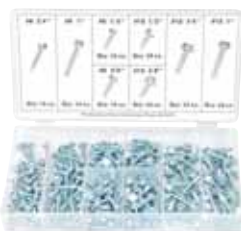

Description	Qty:	Description	Qty:
#8 x 3/4"	30	#10 x 1/2"	20
#8 x 1"	30	#10 x 5/8"	20
#8 x 1 1/2"	30	#10 x 3/4"	20
#8 x 5/8"	30	#10 x 1"	20

KT100084 170-piece U-clip and Screw Assortment

170-piece U-clip and screw assortment kit includes nine popular products in variety of sizes.



Description	Qty:	Description	Qty:
#6 x 5/16" (3 x 8mm)	40	#6 (3mm) *large	20
#8 x 5/8" (4 x 16mm)	20	#8 (4mm)	20
#10 x 1/2" (5 x 13mm)	15	#10 (5mm)	15
1/4" x 3/4" (6 x 19mm)	10	1/4" (6mm)	10
#6 (3mm) *small	20		

KT100086 270-piece HNBR O-Ring Assortment

270-piece high temperature HNBR O-ring kit assortment includes wide variety of green O-rings in 17 sizes used in A/C applications.



Description	Qty:	Description	Qty:
7/32" x 1/16" (5.29 x 1.78)	20	7/16" x 5/64" (11.00 x 2.00)	15
1/4" x 1/16" (6.07 x 1.78)	20	1/2" x 5/64" (12.00 x 2.00)	15
9/32" x 5/64" (6.80 x 1.90)	20	9/16" x 1/16" (13.90 x 1.80)	10
5/16" x 1/16" (7.65 x 1.78)	20	9/16" x 3/32" (13.95 x 2.62)	10
5/16" x 5/64" (7.80 x 1.90)	20	3/8" x 5/64" (10.00 x 2.00)	10
5/16" x 5/64" (8.00 x 2.00)	20	5/8" x 5/64" (15.00 x 2.00)	10
11/32" x 5/64" (8.80 x 1.90)	20	11/16" x 5/64" (17.00 x 2.00)	10
7/16" x 1/16" (10.82 x 1.78)	15	11/16" x 1/16" (17.17 x 1.78)	10
7/16" x 3/32" (10.77 x 2.62)	15	11/16" x 1/8" (17.04 x 3.53)	10

KT100087 360-piece Terminal Assortment

Kit contains 360 insulated PVC-sleeve, zinc-plated wire terminals and connectors. Essential for automotive, small-engine, appliance and electrical repair. Includes 13 of the most common wire connection sizes and styles.



Description	Qty:	Description	Qty:
10-32 ring 16-14 ga.	30	Butt connector 16-14 ga.	15
3/8" ring 16-14 ga.	20	Butt connector 12-10 ga.	15
1/4" ring 16-14 ga.	20	Male bullet 16-14 ga.	10
10-32 ring 12-10 ga.	20	Female bullet 16-14 ga.	10
3/8" ring 12-10 ga.	15	Two-way line connector	10
1/4" ring 12-10 ga.	15	Male disconnect 18-14 ga.	10
10 spade 16-14 ga.	30	Female disconnect 18-14 ga.	10
10 spade 12-10 ga.	20	Male ins. disconnect 18-14	10
Butt connector 22-16 ga.	30	Female ins. disconnect 18-14	10

KITS

Hardware kits are packaged in multicompartment cases, but do not have individual pieces available for refill. Contains product assortment map for easy identification of components.

KT100089 110-piece Copper Washer Assortment

110-piece copper washer assortment kit includes six popular products, ranging from 1/4" to 5/8".



Description	Qty:	Description	Qty:
1/4".....	30	7/16".....	15
5/16".....	25	1/2".....	10
3/8".....	20	5/8".....	10

KT100091 125-piece Grommet Assortment

125-piece grommet assortment kit includes 18 popular products, ranging from 1/8" to 1".



Description	Qty:	Description	Qty:
1/8" x 1/4".....	15	5/8" x 31/32".....	3
7/32" x 5/16".....	10	3/4" x 15/16".....	2
9/32" x 1/2".....	7	9/32".....	20
1/2" x 19/32".....	3	3/8".....	20
3/8" x 15/32".....	6	1/2".....	10
3/8" x 1/2".....	5	5/8".....	5
5/16" x 9/16".....	3	3/4".....	4
3/8" x 13/16".....	3	7/8".....	3
7/16" x 3/4".....	4	1".....	2

KT100095 419-piece Metric O-ring Assortment

419-piece metric O-ring kit. Huge assortment includes 32 different products, ranging in size from 3mm to 50mm ID.



Description	Qty:	Description	Qty:
3mm x 1.5mm.....	20	20mm x 3.5mm.....	10
4.4mm x 2mm.....	20	22mm x 3.5mm.....	10
5mm x 2mm.....	18	23.5mm x 3.5mm.....	10
7mm x 1.5mm.....	23	25mm x 3.5mm.....	10
10mm x 1.5mm.....	23	26.5mm x 3.5mm.....	10
13mm x 1.5mm.....	23	28mm x 3.5mm.....	10
10mm x 2.5mm.....	14	30mm x 3.5mm.....	10
11mm x 2.5mm.....	13	31mm x 3.5mm.....	10
13mm x 2.5mm.....	14	33mm x 3.5mm.....	10
14mm x 2.5mm.....	13	34.5mm x 3.5mm.....	10
16mm x 2.5mm.....	14	36mm x 3.5mm.....	10
18mm x 2.5mm.....	14	38mm x 3.5mm.....	10
19mm x 2.5mm.....	13	41mm x 3.5mm.....	10
21mm x 2.5mm.....	14	44mm x 3.5mm.....	10
22mm x 2.5mm.....	13	47mm x 3.5mm.....	10
18mm x 3.5mm.....	10	50mm x 3.5mm.....	10

KT100093 120-piece Roll Pin Assortment

120-piece roll pin assortment kit includes 30 of the most popular sizes.



Description	Qty:	Description	Qty:
5/32" x 5/8".....	4	3/8" x 3/4".....	2
5/32" x 1".....	4	3/8" x 1-1/2".....	2
5/32" x 1-1/2".....	4	3/8" x 2".....	2
1/4" x 5/8".....	4	3/32" x 5/8".....	4
1/4" x 1-1/4".....	4	3/32" x 1".....	4
1/4" x 1-3/4".....	4	3/32" x 1-1/4".....	4
5/64" x 1/4".....	4	7/32" x 5/8".....	4
5/64" x 1/2".....	4	7/32" x 1-1/4".....	4
5/64" x 1".....	4	7/32" x 1-3/4".....	4
1/16" x 3/16".....	4	1/8" x 5/8".....	4
1/16" x 5/16".....	4	1/8" x 1".....	2
1/16" x 3/4".....	4	1/8" x 1-1/4".....	2
5/16" x 3/4".....	4	3/16" x 5/8".....	2
5/16" x 1-1/2".....	4	3/16" x 1".....	4
5/16" x 2".....	4	3/16" x 1-1/4".....	4

KT100094 407-piece Universal O-ring Assortment

407-piece universal O-ring kit. Huge assortment includes 34 different products, ranging in size from 1/8" to 2" ID and 1/4" to 2-1/4" OD.



Description	Qty:	Description	Qty:
1/8" x 1/4" x 1/16".....	20	13/16" x 1-1/16" x 1/8".....	10
3/16" x 5/16" x 1/16".....	20	7/8" x 1-1/8" x 1/8".....	10
1/4" x 3/8" x 1/16".....	20	15/16" x 1-3/16" x 1/8".....	10
5/16" x 7/16" x 1/16".....	20	1" x 1-1/4" x 1/8".....	10
3/8" x 1/2" x 1/16".....	20	1-1/16" x 1-15/16" x 1/8".....	10
1/2" x 5/8" x 1/16".....	20	1-1/8" x 1-3/8" x 1/8".....	10
3/8" x 9/16" x 3/32".....	13	1-3/16" x 1-7/16" x 1/8".....	10
7/16" x 5/8" x 3/32".....	13	1-1/4" x 1-1/2" x 1/8".....	10
1/2" x 11/16" x 3/32".....	13	1-5/16" x 1-9/16" x 1/8".....	10
9/16" x 3/4" x 3/32".....	13	1-3/8" x 1-5/8" x 1/8".....	10
5/8" x 13/16" x 3/32".....	13	1-7/16" x 1-11/16" x 1/8".....	10
11/16" x 7/8" x 3/32".....	13	1-1/2" x 1-3/4" x 1/8".....	10
3/4" x 15/16" x 3/32".....	13	1-5/8" x 1-7/8" x 1/8".....	10
13/16" x 1" x 3/32".....	13	1-3/4" x 2" x 1/8".....	10
7/8" x 1-1/16" x 3/32".....	13	1-7/8" x 2-1/8" x 1/8".....	10
3/4" x 1" x 1/8".....	10	2" x 2-1/4" x 1/8".....	10

Electrical and Hardware Components

KITS Hardware kits are packaged in multicompartment cases, but do not have individual pieces available for refill. Contains product assortment map for easy identification of components.

KT100096
110-piece Metric Grease Fitting Assortment

110-piece metric grease fitting assortment kit includes six popular sizes, ranging from 6mm to 10mm.



Description	Qty:	Description	Qty:
6mm.....	30	10mm (90°).....	20
6mm (45°).....	15	10mm (45°).....	15
6mm (90°).....	15	10mm.....	15

KT100097
157-piece Electric Wire Solderless Terminal Kit

157-piece electric wire solderless terminal kit includes 17 popular sizes for 10-18 gauge wire. Products are color-coded for convenience.



Description	Qty:	Description	Qty:
#8 ring terminal 16-14 ga.....	11	Female connector 16-14 ga.....	11
#10 ring terminal 16-14 ga.....	11	Male connector 12-10 ga.....	4
1/4" ring terminal 16-14 ga.....	11	Female terminal 12-10 ga.....	4
5/16" ring terminal 12-10 ga.....	8	Male bullet 16-14 ga.....	11
3/8" ring terminal 12-10 ga.....	4	Female bullet 16-14 ga.....	11
Butt connect 22-18 ga.....	11	#8 spade terminal 16-14 ga.....	11
Butt connect 16-14 ga.....	22	Quick splice and tap 16-14 ga.....	4
Butt connect 12-10 ga.....	8	Quick splice and tap 22-18 ga.....	4
Male connector 16-14 ga.....	11		

KT107740
235-piece Heat Shrink Tube Kit

235-piece heat shrink tube kit. Assortment includes eight different sizes in five colors, ranging from 3/32" to 5/8".



Size: 1/8"	Qty:	Size: 1/4"	Qty:	Size: 5/8"	Qty:
Blue.....	11	Blue.....	11	Blue.....	1
Black.....	11	Black.....	11	Black.....	1
Orange.....	11	Orange.....	11	Orange.....	1
Green.....	11	Green.....	11	Green.....	1
Yellow.....	11	Yellow.....	11	Yellow.....	1

Size: 3/32"	Qty:	Size: 3/8"	Qty:	Size: 3/4"	Qty:
Blue.....	8	Blue.....	2	Blue.....	1
Black.....	8	Black.....	2	Black.....	1
Orange.....	8	Orange.....	2	Orange.....	1
Green.....	8	Green.....	2	Green.....	1
Yellow.....	8	Yellow.....	2	Yellow.....	1

Size: 3/16"	Qty:	Size: 1/2"	Qty:
Blue.....	11	Blue.....	2
Black.....	11	Black.....	2
Orange.....	11	Orange.....	2
Green.....	11	Green.....	2
Yellow.....	11	Yellow.....	2

KT100033
216-Piece Heat Shrink Tubing Assortment Set

Tubing protects and insulates components and wires. Quick and simple to shrink with heat gun. Shrink ratio 2:1. Assortment includes sizes ranging from 2.5mm to 20mm.



Description	Qty:	Description	Qty:
2.5mm x 45mm, Color black.....	50	6mm x 45mm, Color red.....	5
2.5mm x 45mm, Color red.....	20	10mm x 45mm, Color black.....	10
3.5mm x 45mm, Color black.....	30	10mm x 45mm, Color red.....	10
3.5mm x 45mm, Color red.....	15	13mm x 45mm, Color black.....	10
4.5mm x 45mm, Color black.....	20	13mm x 45mm, Color red.....	10
4.5mm x 45mm, Color red.....	10	20mm x 75mm, Color black.....	8
6mm x 45mm, Color black.....	10	20mm x 75mm, Color red.....	8

KT100034
105-Piece Dual-Wall Heat Shrink Tubing Assortment Set

Tubing protects and insulates components and wires. Quick and simple to shrink with heat gun. Shrink ratio 3:1, waterproof. Use for auto, home, marine, aviation, industrial & office. Assortment includes sizes ranging from 3.2mm to 25.4mm.



Description	Qty:	Description	Qty:
3.2mm x 45mm, Color black.....	28	9.5mm x 45mm, Color red.....	3
3.2mm x 45mm, Color red.....	12	12.7mm x 75mm, Color black.....	5
4.8mm x 45mm, Color black.....	16	12.7mm x 75mm, Color red.....	3
4.8mm x 45mm, Color red.....	8	19.1mm x 75mm, Color black.....	3
6.4mm x 45mm, Color black.....	7	19.1mm x 75mm, Color red.....	2
6.4mm x 45mm, Color red.....	4	25.4mm x 75mm, Color black.....	4
9.5mm x 45mm, Color black.....	6	25.4mm x 75mm, Color red.....	4



Displays and Merchandisers

Displays and Merchandisers

KTI's eye-catching displays, featuring a popular assortment of merchandise, allow store owners to exhibit a maximum quantity of quick-selling products in a minimum amount of space. KTI displays allow stores to expand their tool offering without investing large sums in inventory or floor space. Each display measures 23.5" x 32". Easy to set up, the display ships with all needed tools, overlay and hardware (hooks, bars, fasteners, etc.). Board must be purchased separately (KTI098).

KTI0805 1/4" Drive Tools and Sockets

Conversion kit only:
KTU0805

See page
182
for display
content listing



KTI0806 3/8" Drive Tools and Sockets

Conversion kit only:
KTU0806

See page
182
for display
content listing



KTI0807 3/8" Drive Sockets

Conversion kit only:
KTU0807

See page
182-183
for display
content listing



KTI0808 1/2" Drive Tools and Sockets

Conversion kit only:
KTU0808

See pages
183-184
for display
content listing



KTI0809 Screwdrivers

Conversion kit only:
KTU0809

See page
184
for display
content listing



KTI's eye-catching displays, featuring a popular assortment of merchandise, allow store owners to exhibit a maximum quantity of quick-selling products in a minimum amount of space. KTI displays allow stores to expand their tool offering without investing large sums in inventory or floor space. Each display measures 23.5" x 32". Easy to set up, the display ships with all needed tools, overlay and hardware (hooks, bars, fasteners, etc.). Board must be purchased separately (KTI098).

KTI0836
Nutdrivers
and Hex Keys

See pages
 188
 for display
 content listing



KTI0810
Torq and
Hex Sockets
 Conversion kit only:
KTU0810

See page
 184
 for display
 content listing



KTI0811
Torx and Hex
Sockets (U.S.-made)
 Conversion kit only:
KTU0811

See page
 184-185
 for display
 content listing



KTI0839
Impact
Sockets

See pages
 189-190
 for display
 content listing



KTI0840
Large Impact
Sockets

See page
 190
 for display
 content listing



KTI0812
Fractional
Wrenches
 Conversion kit only:
KTU0812

See page
 185
 for display
 content listing

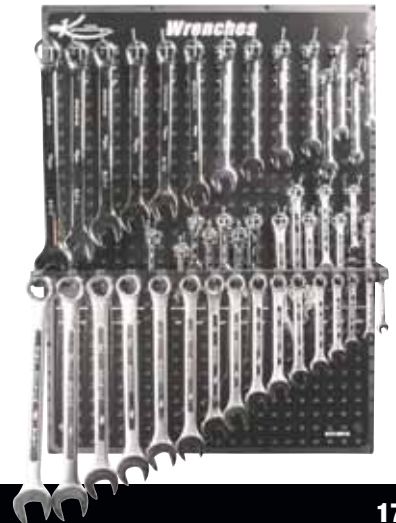

Displays and Merchandisers

KTI's eye-catching displays, featuring a popular assortment of merchandise, allow store owners to exhibit a maximum quantity of quick-selling products in a minimum amount of space. KTI displays allow stores to expand their tool offering without investing large sums in inventory or floor space. Each display measures 23.5" x 32". Easy to set up, the display ships with all needed tools, overlay and hardware (hooks, bars, fasteners, etc.). Board must be purchased separately (KTI098).

KTI0813 Metric Wrenches

Conversion kit only:
KTU0813

See pages
185
for display
content listing



KTI0842 Ratcheting Wrenches

See page
190
for display
content listing



KTI0814 Jumbo Wrenches

Conversion kit only:
KTU0814

See page
185
for display
content listing



KTI0817 Adjustable Wrenches

Conversion kit only:
KTU0817

See page
186
for display
content listing



KTI0815 Nylon Ties

Conversion kit only:
KTU0815

See page
186
for display
content listing



KTI0816 Pliers

Conversion kit only:
KTU0816

See page
186
for display
content listing



KTI's eye-catching displays, featuring a popular assortment of merchandise, allow store owners to exhibit a maximum quantity of quick-selling products in a minimum amount of space. KTI displays allow stores to expand their tool offering without investing large sums in inventory or floor space. Each display measures 23.5" x 32". Easy to set up, the display ships with all needed tools, overlay and hardware (hooks, bars, fasteners, etc.). Board must be purchased separately (KTI098).

KTI0819
Files and Scrapers
 Conversion kit only:
KTU0819

See page
 186
 for display
 content listing



KTI0820
Hammers
 Conversion kit only:
KTU0820

See page
 186
 for display
 content listing



KTI0821
Snap Ring Pliers
 Conversion kit only:
KTU0821

See page
 186
 for display
 content listing



KTI0822
Tie Downs and Tow Straps
 Conversion kit only:
KTU0822

See page
 186
 for display
 content listing



KTI0831
Punches and Chisels
 Conversion kit only:
KTU0831

See page
 186-187
 for display
 content listing



KTI0832
Pneumatic Bits
 Conversion kit only:
KTU0832

See page
 187
 for display
 content listing



Displays and Merchandisers

KTI's eye-catching displays, featuring a popular assortment of merchandise, allow store owners to exhibit a maximum quantity of quick-selling products in a minimum amount of space. KTI displays allow stores to expand their tool offering without investing large sums in inventory or floor space. Each display measures 23.5" x 32". Easy to set up, the display ships with all needed tools, overlay and hardware (hooks, bars, fasteners, etc.). Board must be purchased separately (KTI098).

KTI0837 Oil Filter Wrenches

See page
189
for display
content listing



KTI0833 Pullers Conversion kit only: KTU0833

See page
187
for display
content listing



KTI0838 Pullers and Separators

See page
189
for display
content listing



KTI0834 Popular Tools I Conversion kit only: KTU0834

See pages
187-188
for display
content listing



KTI0835 Popular Tools II

See page
188
for display
content listing



KTI0841 Locking Pliers and Clamps

See page
190
for display
content listing



KTI's eye-catching displays, featuring a popular assortment of merchandise, allow store owners to exhibit a maximum quantity of quick-selling products in a minimum amount of space. KTI displays allow stores to expand their tool offering without investing large sums in inventory or floor space. Each display measures 23.5" x 32". Easy to set up, the display ships with all needed tools, overlay and hardware (hooks, bars, fasteners, etc.). Board must be purchased separately (KTI098).

KTI0843
Electrical and Hardware
Component Assortment Display

- Contains 16 of the most popular electrical and hardware component kits
- Attractive retail packaging is prominently merchandised on the 23.5" x 32" display (not included)
- Exhibit a maximum quantity of quick-selling products in a minimum amount of space
- Can be used over 1/4" pegboard or with KTI display board kit (KTI-005 sold separately)

See page
 191
 for display
 content listing



Display board NOT included

KTI005
Display Board, Fasteners
and Slanted Wire Shelves

- Easy to set up
- Allows stores to expand their component offering without investing large sums in inventory or floor space
- Includes: KTI display board, overlay, fasteners and slanted wire shelves.

Shelves measure 6" x 23.5" each.



**CONTAINS DISPLAY BOARD,
 OVERLAY, FASTENERS & SHELVES ONLY
 NO PRODUCT INCLUDED**



Displays and Merchandisers

tKTI0805

1/4" Drive Tools and Sockets	Qty
KTI21000 1/4" Dr Socket Set.....	1
KTI21002 1/4" Dr 2" Extension.....	1
KTI21004 1/4" Dr 4" Extension.....	1
KTI21006 1/4" Dr 6" Extension.....	1
KTI21010 1/4" Drive Extension 10".....	1
KTI21014 1/4" Drive Extension 14".....	1
KTI21043 4"Wobble Extension 1/4" Dr.....	1
KTI21044 1/4" Drive 44Pc Socket Set.....	1
KTI21046 6"Wobble Extension 1/4" Dr.....	1
KTI21048 9"Wobble Extension 1/4" Dr.....	1
KTI21050 1/4" Dr Universal Joint.....	1
KTI21060 1/4" Dr Spinner Handle.....	1
KTI21091 1/4" Dr Push Button Ratchet.....	1
KTI21092 1/4" Pro Ratchet.....	1
KTI21095 Long Handle 1/4" Drive Ratchet.....	1
KTI21106 1/4" Dr Short Socket 3/16".....	1
KTI21107 1/4" Dr Short Socket 7/32".....	1
KTI21108 1/4" Dr Short Socket 1/4".....	1
KTI21109 1/4" Dr Short Socket 9/32".....	1
KTI21110 1/4" Dr Short Socket 5/16".....	1
KTI21111 1/4" Dr Short Socket 11/32".....	1
KTI21112 1/4" Dr Short Socket 3/8".....	1
KTI21114 1/4" Dr Short Socket 7/16".....	1
KTI21116 1/4" Dr Short Socket 1/2".....	1
KTI21118 1/4" Dr 6 Point Short Socket 9/16".....	1
KTI21206 1/4" Dr Deep Socket 3/16".....	1
KTI21207 1/4" Dr Deep Socket 7/32".....	1
KTI21208 1/4" Dr Deep Socket 1/4".....	1
KTI21209 1/4" Dr Deep Socket 9/32".....	1
KTI21210 1/4" Dr Deep Socket 5/16".....	1
KTI21211 1/4" Dr Deep Socket 11/32".....	1
KTI21212 1/4" Dr Deep Socket 3/8".....	1
KTI21214 1/4" Dr Deep Socket 7/16".....	1
KTI21216 1/4" Dr Deep Socket 1/2".....	1
KTI21218 1/4" Dr 6 Point Deep Socket 9/16".....	1
KTI26000 1/4" Dr Metric Socket Set.....	1
KTI26104 1/4" Dr Short Socket 4 mm.....	1
KTI26105 1/4" Dr Short Socket 5 mm.....	1
KTI26106 1/4" Dr Short Socket 6 mm.....	1
KTI26107 1/4" Dr Short Socket 7 mm.....	1
KTI26108 1/4" Dr Short Socket 8 mm.....	1
KTI26109 1/4" Dr Short Socket 9 mm.....	1
KTI26110 1/4" Dr Short Socket 10 mm.....	1
KTI26111 1/4" Dr Short Socket 11 mm.....	1
KTI26114 1/4" Dr 6 Point Short Socket 14mm.....	1
KTI26115 1/4" Dr 6 Point Short Socket 15mm.....	1
KTI26155 1/4" Dr Short Socket 5.5mm.....	1
KTI26206 1/4" Dr Deep Socket 6 mm.....	1
KTI26207 1/4" Dr Deep Socket 7 mm.....	1
KTI26208 1/4" Dr Deep Socket 8 mm.....	1
KTI26209 1/4" Dr Deep Socket 9 mm.....	1
KTI26210 1/4" Dr Deep Socket 10 mm.....	1
KTI26211 1/4" Dr Deep Socket 11 mm.....	1
KTI26212 1/4" Dr Deep Socket 12 mm.....	1
KTI26213 1/4" Dr Deep Socket 13 mm.....	1
KTI26214 1/4" Dr 6Point Deep Socket 14mm.....	1
KTI26215 1/4" Dr 6 Point Deep Socket 15mm.....	1
KTI26255 1/4" Dr Deep Socket 5.5 mm.....	1
KTIH00K2 Hooks.....	38
KTIH00K3 Hooks.....	4
KTIOL0805 Display Overlay.....	1
KTIOLF-04333 Overlay Fasteners (6 Pack).....	1

KTI0806

3/8" Drive Tools and Sockets	Qty
KTI21055 1/4" F X 3/8" M Adapter.....	1
KTI22000 3/8" Drive Socket Set.....	1
KTI22002 3/8" Dr Extension 2".....	1
KTI22003 3/8" Dr Extension 3".....	1
KTI22005 3/8" Dr Extension 5".....	1
KTI22006 3/8" Dr Extension 6".....	1
KTI22008 3/8" Dr Extension 8".....	1

KTI22010 3/8" Dr Extension 10".....	1
KTI22012 3/8" Dr Extension 12".....	1
KTI22018 3/8" Dr Extension 18".....	1
KTI22024 3/8" Dr Extension 24".....	1
KTI22043 3/8" Dr Wobble Extension 3".....	1
KTI22046 3/8" Dr Wobble Extension 6".....	1
KTI22047 3/8" Drive 47Pc Socket Set 6 Point.....	1
KTI22048 3/8" Dr Wobble Extension 8".....	1
KTI22050 1/2" F X 3/8" M Adapter.....	1
KTI22055 3/8" F X 1/2" M Adapter.....	1
KTI22060 3/8" F X 1/4" M Adapter.....	1
KTI22091 3/8" Dr Push Button Ratchet.....	1
KTI22092 3/8" Pro Ratchet.....	1
KTI22093 3/8" Dr Flex Head Ratchet.....	1
KTI22095 Long Handle 3/8" Drive Ratchet.....	1
KTI22219 Extra Deep 5/8" Spark Plug Skt.....	1
KTI22221 3/8" Dr Sparkplug Skt 6Pt 5/8".....	1
KTI22227 3/8" Dr Sparkplug Skt 6Pt 13/16".....	1
KTI22500 Universal Joint 3/8" Drive.....	1
KTI22521 5/8"Sparkplug Skt 3/8" Dr Univ.....	1
KTI22527 13/16"Sparkplug Skt 3/8" Dr Unv.....	1
KTI27000 3/8" Dr Metric Socket Set.....	1
KTI089 Extension Bar.....	1
KTIHOOK2 Hooks.....	19
KTIHOOK11 Hooks-Plastic.....	11
KTIOL0806 Display Overlay.....	1
KTIOLF-04333 Overlay Fasteners (6 Pack).....	1

KTI0807

3/8" Drive Sockets	Qty
KTI22110 3/8" Dr Short Socket 5/16".....	1
KTI22112 3/8" Dr Short Socket 3/8".....	1
KTI22114 3/8" Dr Short Socket 7/16".....	1
KTI22116 3/8" Dr Short Socket 1/2".....	1
KTI22118 3/8" Dr Short Socket 9/16".....	1
KTI22120 3/8" Dr Short Socket 5/8".....	1
KTI22122 3/8" Dr Short Socket 11/16".....	1
KTI22124 3/8" Dr Short Socket 3/4".....	1
KTI22126 3/8" Dr Short Socket 13/16".....	1
KTI22128 3/8" Dr Short Socket 7/8".....	1
KTI22130 3/8" Dr 6 Point Socket 15/16".....	1
KTI22132 3/8" Dr 6 Point Socket 1".....	1
KTI22133 2/1 Socket 1X1-1/16 Chrome Van.....	1
KTI22212 3/8" Dr Deep Socket 3/8".....	1
KTI22214 3/8" Dr Deep Socket 7/16".....	1
KTI22216 3/8" Dr Deep Socket 1/2".....	1
KTI22218 3/8" Dr Deep Socket 9/16".....	1
KTI22220 3/8" Dr Deep Socket 5/8".....	1
KTI22222 3/8" Dr Deep Socket 11/16".....	1
KTI22224 3/8" Dr Deep Socket 3/4".....	1
KTI22226 3/8" Dr Deep Socket 13/16".....	1
KTI22228 3/8" Dr Deep Socket 7/8".....	1
KTI22230 3/8" Dr 6 Point Socket 15/16".....	1
KTI22232 3/8" Dr 6 Point Deep Socket 1".....	1
KTI22408 3/8" Dr 12Pt Deep Socket 1/4.....	1
KTI22410 3/8" Dr 12Pt Deep Socket 5/16.....	1
KTI22412 3/8" Dr 12Pt Deep Socket 3/8.....	1
KTI22414 3/8" Dr 12Pt Deep Socket 7/16.....	1
KTI22416 3/8" Dr 12Pt Deep Socket 1/2.....	1
KTI22418 3/8" Dr 12Pt Deep Socket 9/16.....	1
KTI22420 3/8" Dr 12Pt Deep Socket 5/8.....	1
KTI22422 3/8" Dr 12Pt Deep Socket 11/16.....	1
KTI22424 3/8" Dr 12Pt Deep Socket 3/4.....	1
KTI22426 3/8" Dr 12Pt Deep Socket 13/16.....	1
KTI22428 3/8" Dr 12Pt Deep Socket 7/8.....	1
KTI22430 3/8" Dr 12Pt Deep Socket 15/16.....	1
KTI22432 3/8" Dr 12Pt Deep Socket 1".....	1
KTI22508 3/8" Dr 12Pt Short Socket 1/4.....	1
KTI22510 3/8" Dr 12Pt Short Socket 5/16.....	1
KTI22512 3/8" Dr 12Pt Short Socket 3/8.....	1
KTI22514 3/8" Dr 12Pt Short Socket 7/16.....	1
KTI22516 3/8" Dr 12Pt Short Socket 1/2.....	1
KTI22518 3/8" Dr 12Pt Short Socket 9/16.....	1
KTI22520 3/8" Dr 12Pt Short Socket 5/8.....	1
KTI22522 3/8" Dr 12Pt Short Socket 11/16.....	1



KTIO807

3/8" Drive Sockets (continued)	Qty	
KT122524	3/8" Dr 12Pt Short Socket 3/4	1
KT122526	3/8" Dr 12Pt Short Socket 13/16	1
KT122528	3/8" Dr 12Pt Short Socket 7/8	1
KT122530	3/8" Dr 12Pt Short Socket 15/16	1
KT122532	3/8" Dr 12Pt Short Socket 1"	1
KT127108	3/8" Dr Short Socket 8mm	1
KT127109	3/8" Dr Short Socket 9mm	1
KT127110	3/8" Dr Short Socket 10mm	1
KT127111	3/8" Dr Short Socket 11mm	1
KT127112	3/8" Dr Short Socket 12mm	1
KT127113	3/8" Dr Short Socket 13mm	1
KT127114	3/8" Dr Short Socket 14mm	1
KT127115	3/8" Dr Short Socket 15mm	1
KT127116	3/8" Dr Short Socket 16mm	1
KT127117	3/8" Dr Short Socket 17mm	1
KT127118	3/8" Dr Short Socket 18mm	1
KT127119	3/8" Dr Short Socket 19mm	1
KT127120	3/8" Dr Short Socket 20mm	1
KT127121	3/8" Dr Short Socket 21mm	1
KT127122	3/8" Dr 6 Point Short Socket 22mm	1
KT127123	3/8" Dr 6 Point Short Socket 23mm	1
KT127124	3/8" Dr 6 Point Short Socket 24mm	1
KT127125	3/8" Dr 6 Point Short Socket 25mm	1
KT127126	3/8" Dr 6 Point Short Socket 26mm	1
KT127210	3/8" Dr Deep Socket 10mm	1
KT127211	3/8" Dr Deep Socket 11mm	1
KT127212	3/8" Dr Deep Socket 12mm	1
KT127213	3/8" Dr Deep Socket 13mm	1
KT127214	3/8" Dr Deep Socket 14mm	1
KT127215	3/8" Dr Deep Socket 15mm	1
KT127216	3/8" Dr Deep Socket 16mm	1
KT127217	3/8" Dr Deep Socket 17mm	1
KT127218	3/8" Dr Deep Socket 18mm	1
KT127219	3/8" Dr Deep Socket 19mm	1
KT127220	3/8" Dr 6 Point Deep Socket 20mm	1
KT127221	3/8" Dr 6 Point Deep Socket 21mm	1
KT127222	3/8" Dr 6 Point Deep Socket 22mm	1
KT127223	3/8" Dr 6 Point Deep Socket 23mm	1
KT127224	3/8" Dr 6 Point Deep Socket 24mm	1
KT127225	3/8" Dr 6 Point Deep Socket 25mm	1
KT127226	3/8" Dr 6 Point Deep Socket 26mm	1
KT127407	3/8" Dr 12Pt Deep Socket 7mm	1
KT127408	3/8" Dr 12Pt Deep Socket 8mm	1
KT127409	3/8" Dr 12Pt Deep Socket 9mm	1
KT127410	3/8" Dr 12Pt Deep Socket 10mm	1
KT127411	3/8" Dr 12Pt Deep Socket 11mm	1
KT127412	3/8" Dr 12Pt Deep Socket 12mm	1
KT127413	3/8" Dr 12Pt Deep Socket 13mm	1
KT127414	3/8" Dr 12Pt Deep Socket 14mm	1
KT127415	3/8" Dr 12Pt Deep Socket 15mm	1
KT127416	3/8" Dr 12Pt Deep Socket 16mm	1
KT127417	3/8" Dr 12Pt Deep Socket 17mm	1
KT127418	3/8" Dr 12Pt Deep Socket 18mm	1
KT127419	3/8" Dr 12Pt Deep Socket 19mm	1
KT127420	3/8" Dr 12Pt Deep Socket 20mm	1
KT127421	3/8" Dr 12Pt Deep Socket 21mm	1
KT127507	3/8" Dr 12Pt Short Socket 7mm	1
KT127508	3/8" Dr 12Pt Short Socket 8mm	1
KT127509	3/8" Dr 12Pt Short Socket 9mm	1
KT127510	3/8" Dr 12Pt Short Socket 10mm	1
KT127511	3/8" Dr 12Pt Short Socket 11mm	1
KT127512	3/8" Dr 12Pt Short Socket 12mm	1
KT127513	3/8" Dr 12Pt Short Socket 13mm	1
KT127514	3/8" Dr 12Pt Short Socket 14mm	1
KT127515	3/8" Dr 12Pt Short Socket 15mm	1
KT127516	3/8" Dr 12Pt Short Socket 16mm	1
KT127517	3/8" Dr 12Pt Short Socket 17mm	1
KT127518	3/8" Dr 12Pt Short Socket 18mm	1
KT127519	3/8" Dr 12Pt Short Socket 19mm	1
KT127520	3/8" Dr 12Pt Short Socket 20mm	1
KT127521	3/8" Dr 12Pt Short Socket 21mm	1
KT1H00K2	Hooks	60
KT1OL0807	Display Overlay	1

KTIO807

3/8" Drive Sockets (continued)	Qty	
KT1OLF-04333	Overlay Fasteners (6 Pack)	1

KTIO808

1/2" Drive Tools and Sockets	Qty	
KT122075	Chrome Adapter 1/2" F X 3/4" M	1
KT123003	1/2" Dr 3" Extension	1
KT123005	1/2" Dr 5" Extension	1
KT123010	1/2" Dr 10" Extension	1
KT123015	1/2" Dr Extension 15"	1
KT123020	1/2" Dr Extension 20"	1
KT123080	1/2" Dr 17" Breaker Bar	1
KT123081	1/2" Dr 24" Breaker Bar	1
KT123091	1/2" Dr Push Button Ratchet	1
KT123092	1/2" Pro Ratchet	1
KT123112	1/2" Dr 6 Point Short Socket 3/8"	1
KT123114	1/2" Dr Short Socket 7/16"	1
KT123116	1/2" Dr Short Socket 1/2"	1
KT123118	1/2" Dr Short Socket 9/16"	1
KT123120	1/2" Dr Short Socket 5/8"	1
KT123122	1/2" Dr Short Socket 11/16"	1
KT123124	1/2" Dr Short Socket 3/4"	1
KT123126	1/2" Dr Short Socket 13/16"	1
KT123128	1/2" Dr Short Socket 7/8"	1
KT123130	1/2" Dr Short Socket 15/16"	1
KT123132	1/2" Dr Short Socket 1"	1
KT123134	1/2" Dr Short Socket 1-1/16"	1
KT123136	1/2" Dr Short Socket 1-1/8"	1
KT123140	1/2" Dr Short Socket 1-1/4"	1
KT123142	1/2" Dr 6 Point Short Socket 1-5/16"	1
KT123144	1/2" Dr 6 Point Short Socket 1-3/8"	1
KT123146	1/2" Dr 6 Point Short Socket 1-7/16"	1
KT123148	1/2" Dr 6 Point Short Socket 1-1/2"	1
KT123214	1/2" Dr 6 Point Deep Socket 7/16"	1
KT123216	1/2" Dr Deep 6 Pt.Socket 1/2"	1
KT123218	1/2" Dr Deep 6 Pt.Socket 9/16"	1
KT123220	1/2" Dr Deep 6 Pt.Socket 5/8"	1
KT123222	1/2" Dr Deep 6 Pt.Socket 11/16"	1
KT123224	1/2" Dr Deep 6 Pt.Socket 3/4"	1
KT123226	1/2" Dr Deep 6 Pt.Socket 13/16"	1
KT123228	1/2" Dr Deep 6 Pt.Socket 7/8"	1
KT123230	1/2" Dr Deep 6 Pt.Socket 15/16"	1
KT123232	1/2" Dr 6 Point Deep Socket 1"	1
KT123234	1/2" Dr 6 Point Deep Socket 1-1/16"	1
KT123236	1/2" Dr 6 Point Deep Socket 1-1/8"	1
KT123240	1/2" Dr 6 Point Deep Socket 1-1/4"	1
KT123242	1/2" Dr 6 Point Deep Socket 1-5/16"	1
KT123244	1/2" Dr 6 Point Deep Socket 1-3/8"	1
KT123246	1/2" Dr 6 Point Deep Socket 1-7/16"	1
KT123248	1 1/2" Heating Element Socket	1
KT123500	1/2" Dr.Universal	1
KT123808	1/4" Stud Remover 1/2" Dr.	1
KT123810	5/16" Stud Remover 1/2" Dr.	1
KT123812	3/8" Stud Remover 1/2" Dr.	1
KT123814	7/16" Stud Remover 1/2" Dr.	1
KT123906	6mm Stud Remover 1/2" Dr.	1
KT123908	8 mm Stud Remover	1
KT123910	10 mm Stud Remover	1
KT123912	12mm Stud Remover 1/2" Dr.	1
KT124050	3/4" F X 1/2" M Adapter	1
KT128110	1/2" Dr 6 Point Short Socket 10mm	1
KT128111	1/2" Dr 6 Point Short Socket 11mm	1
KT128112	1/2" Dr 6 Point Short Socket 12mm	1
KT128113	1/2" Dr 6 Point Short Socket 13mm	1
KT128114	1/2" Dr 6 Point Short Socket 14mm	1
KT128115	1/2" Dr Short Socket 15mm	1
KT128116	1/2" Dr Short Socket 16mm	1
KT128117	1/2" Dr Short Socket 17mm	1
KT128118	1/2" Dr Short Socket 18mm	1
KT128119	1/2" Dr Short Socket 19mm	1
KT128120	1/2" Dr Short Socket 20mm	1
KT128121	1/2" Dr Short Socket 21mm	1
KT128122	1/2" Dr Short Socket 22mm	1
KT128123	1/2" Dr Short Socket 23mm	1

Displays and Merchandisers

KTI0808

1/2" Drive Tools and Sockets (continued)		Qty
KTI28124	1/2" Dr Short Socket 24mm	1
KTI28125	1/2" Dr Short Socket 25mm	1
KTI28126	1/2" Dr Short Socket 26mm	1
KTI28127	1/2" Dr Short Socket 27mm	1
KTI28128	1/2" Dr Short Socket 28mm	1
KTI28210	1/2" Dr 6 Point Deep Socket 10mm	1
KTI28211	1/2" Dr 6 Point Deep Socket 11mm	1
KTI28212	1/2" Dr 6 Point Deep Socket 12mm	1
KTI28213	1/2" Dr 6 Point Deep Socket 13mm	1
KTI28214	1/2" Dr 6 Point Deep Socket 14mm	1
KTI28215	1/2" Dr Deep Socket 15mm	1
KTI28216	1/2" Dr Deep Socket 16mm	1
KTI28217	1/2" Dr Deep Socket 17mm	1
KTI28218	1/2" Dr Deep Socket 18mm	1
KTI28219	1/2" Dr Deep Socket 19mm	1
KTI28220	1/2" Dr Deep Socket 20mm	1
KTI28221	1/2" Dr Deep Socket 21mm	1
KTI28222	1/2" Dr Deep Socket 22mm	1
KTI28223	1/2" Dr Deep Socket 23mm	1
KTI28224	1/2" Dr Deep Socket 24mm	1
KTI28225	1/2" Dr 6 Point Deep Socket 25mm	1
KTI28226	1/2" Dr 6 Point Deep Socket 26mm	1
KTI28227	1/2" Dr 6 Point Deep Socket 27mm	1
KTI28228	1/2" Dr 6 Point Deep Socket 28mm	1
KTI089	Extension Bar	2
KTIH00K2	Hooks	34
KTIH00K11	Hooks - Plastic	24
KTIOL0808	Display Overlay	1
KTIOLF-04333	Overlay Fasteners (6 Pack)	1

KTI0809

Screwdrivers		Qty
KTI11310	T-10 Torq Screwdriver	2
KTI11315	T-15 Torq Screwdriver	2
KTI11320	T-20 Torq Screwdriver	2
KTI16001	5 Pc Slotted Screwdriver Set	1
KTI16002	5 Pc Phillips Screwdriver Set	1
KTI16113	#1 Phillips Screwdriver	2
KTI16121	#2 Stubby Phillips Screwdriver	2
KTI16124	#2 Phillips Screwdriver	2
KTI16129	#2 Long Phillips Screwdriver	1
KTI16136	#3 Phillips Screwdriver	2
KTI16201	Stubby Slotted Screwdriver	2
KTI16203	3" Standard Screwdriver	2
KTI16204	4" Standard Screwdriver	2
KTI16206	6" Standard Screwdriver	2
KTI16208	8" Standard Screwdriver	2
KTI19000	8 Pc Screwdriver Set Black	1
KTI19113	#1 Phillips Screwdriver Black	2
KTI19121	#2 Phillips Screwdriver Stubby	2
KTI19124	#2 Phillips Screwdriver Black	2
KTI19201	Stubby Screwdriver Black	2
KTI19203	3" Standard Screwdriver Black	2
KTI19204	4" Standard Screwdriver Black	2
KTI19206	6" Standard Screwdriver Black	2
KTI19208	8" Standard Screwdriver Black	2
KTIH00K2	Hooks	21
KTIH00K8	Hooks	3
KTIOL0809	Display Overlay	1
KTIOLF-04333	Overlay Fasteners (6 Pack)	1

KTI0810

Torq and Hex Sockets		Qty
KTI21810	1/4" Dr Torq Bit T-10	2
KTI21815	1/4" Dr Torq Bit T-15	2
KTI21820	1/4" Dr Torq Bit T-20	2
KTI21825	1/4" Dr Torq Bit T-25	2
KTI21827	1/4" Dr Torq Bit T-27	2
KTI21830	1/4" Dr Torq Bit T-30	2
KTI22800	9Pc Torq Socket Set	1
KTI22801	12Pc Torq Socket Set	1
KTI22840	3/8" Dr Torq Bit T-40	2

KTI0810

Torq and Hex Sockets (continued)		Qty
KTI22845	3/8" Dr Torq Bit T-45	2
KTI22847	3/8" Dr Torq Bit T-47	2
KTI22850	3/8" Dr Torq Bit T-50	2
KTI22855	3/8" Dr Torq Bit T-55	2
KTI22860	3/8" Dr Torq Bit T-60	2
KTI22870	External Torq Socket Set	1
KTI22874	External Torq E-4 1/4" Dr	1
KTI22875	External Torq E-5 1/4" Dr	1
KTI22876	External Torq E-6 1/4" Dr	1
KTI22877	External Torq E-7 1/4" Dr	1
KTI22878	External Torq E-8 1/4" Dr	1
KTI22880	External Torq E-10 3/8" Dr	1
KTI22882	External Torq E-12 3/8" Dr	1
KTI22884	External Torq E-14 3/8" Dr	1
KTI22886	External Torq E-16 3/8" Dr	1
KTI22888	External Torq E-18 3/8" Dr	1
KTI22904	Hex Bit 1/8"	1
KTI22905	Hex Bit 5/32	1
KTI22906	Hex Bit 3/16	1
KTI22907	Hex Bit 7/32	1
KTI22908	Hex Bit 1/4"	1
KTI22910	Hex Bit 5/16"	1
KTI22912	Hex Bit 3/8"	1
KTI22970	7Pc 3/8" Dr Hex Bit Set Fract	1
KTI27903	Metric Hex Bit 3 mm	1
KTI27904	Metric Hex Bit 4 mm	1
KTI27905	Metric Hex Bit 5 mm	1
KTI27906	Metric Hex Bit 6 mm	1
KTI27907	Metric Hex Bit 7 mm	1
KTI27908	Metric Hex Bit 8 mm	1
KTI27910	Metric Hex Bit 10 mm	1
KTI27955	Metric Hex Bit 5.5mm	1
KTI27970	7Pc 3/8" Dr Hex Bit Set Metric	1
KTIH00K2	Hooks	43
KTIOL0810	Display Overlay	1
KTIOLF-04333	Overlay Fasteners (6 Pack)	1

KTI0811

Torx and Hex Sockets (U.S.-made)		Qty
KTI21500	Master Tamper Proof Torx Set 12 Pc	1
KTI21610	1/4" Dr Torx Bit T-10 USA	1
KTI21615	1/4" Dr Torx Bit T-15 USA	1
KTI21620	1/4" Dr Torx Bit T-20 USA	1
KTI21625	1/4" Dr Torx Bit T-25 USA	1
KTI21627	1/4" Dr T52 Torx Bit T-27 USA	1
KTI21630	1/4" Dr Torx Bit T-30 USA	1
KTI22601	12Pc Torx Bit Set T10-T60 USA	1
KTI22640	3/8" Dr Torx Bit T-40 USA	1
KTI22645	3/8" Dr Torx Bit T-45 USA	1
KTI22647	3/8" Dr Torx Bit T-47 USA	1
KTI22650	3/8" Dr Torx Bit T-50 USA	1
KTI22655	3/8" Dr Torx Bit T-55 USA	1
KTI22660	1/2" Dr Torx Bit T-60 USA	1
KTI22670	1/2 Dr T-70 Torx Socket USA	1
KTI22671	External Torq Socket Set	1
KTI22675	External Torq E-5 1/4" Dr	1
KTI22676	External Torq E-6 1/4" Dr	1
KTI22677	External Torq E-7 1/4" Dr	1
KTI22678	External Torq E-8 1/4" Dr	1
KTI22680	External Torq E-10 3/8" Dr	1
KTI22682	External Torq E-12 3/8" Dr	1
KTI22684	External Torq E-14 3/8" Dr	1
KTI22686	External Torq E-16 3/8" Dr	1
KTI22688	External Torq E-18 3/8" Dr	1
KTI22689	External Torq E-20 3/8" Dr	1
KTI22904	Hex Bit 1/8"	1
KTI22905	Hex Bit 5/32	1
KTI22906	Hex Bit 3/16	1
KTI22907	Hex Bit 7/32	1
KTI22908	Hex Bit 1/4"	1
KTI22910	Hex Bit 5/16"	1
KTI22912	Hex Bit 3/8"	1
KTI22970	7Pc 3/8" Dr Hex Bit Set Fract	1
KTI27903	Metric Hex Bit 3 mm	1

KTI0811

Torx and Hex Sockets (U.S.-made) (continued)		Qty
KTI27904	Metric Hex Bit 4 mm	1
KTI27905	Metric Hex Bit 5 mm	1
KTI27906	Metric Hex Bit 6 mm	1
KTI27907	Metric Hex Bit 7 mm	1
KTI27908	Metric Hex Bit 8 mm	1
KTI27910	Metric Hex Bit 10 mm	1
KTI27955	Metric Hex Bit 5.5mm	1
KTI27970	7Pc 3/8" Dr Hex Bit Set Metric	1
KTIHOOK2	Hooks	43
KTIOL0811	Display Overlay	1
KTIOLF-04333	Overlay Fasteners (6 Pack)	1

KTI0812

Fractional Wrenches		Qty
KTI41110	Combination Wrench 5/16"	1
KTI41112	Combination Wrench 3/8"	2
KTI41114	Combination Wrench 7/16"	2
KTI41116	Combination Wrench 1/2"	3
KTI41118	Combination Wrench 9/16"	3
KTI41120	Combination Wrench 5/8"	2
KTI41122	Combination Wrench 11/16"	2
KTI41124	Combination Wrench 3/4"	2
KTI41126	Combination Wrench 13/16"	1
KTI41128	Combination Wrench 7/8"	1
KTI41130	Combination Wrench 15/16"	1
KTI41132	Combination Wrench 1"	1
KTI41134	Combination Wrench 1-1/16"	1
KTI41136	Combination Wrench 1-1/8"	1
KTI41140	Combination Wrench 1-1/4"	1
KTI41142	Jumbo Combo Wrench 1-5/16"	1
KTI41212	3/8" Short Combination Wrench	1
KTI41214	7/16" Short Combination Wrench	1
KTI41216	1/2" Short Combination Wrench	1
KTI41218	9/16" Short Combination Wrench	1
KTI41220	5/8" Short Combination Wrench	1
KTI41222	11/16" Short Combination Wrench	1
KTI41224	3/4" Short Combination Wrench	1
KTI41312	3/8" High Polish Comb. Wrench	2
KTI41314	7/16" High Polish Comb. Wrench	2
KTI41316	1/2" High Polish Comb. Wrench	2
KTI41318	9/16" High Polish Comb. Wrench	2
KTI41320	5/8" High Polish Comb. Wrench	1
KTI41322	11/16" High Polish Comb. Wrench	1
KTI41324	3/4" High Polish Comb. Wrench	1
KTI41326	13/16" High Polish Comb. Wrench	1
KTI41328	7/8" High Polish Comb. Wrench	1
KTI41330	15/16" High Polish Comb. Wrench	1
KTI41332	1" High Polish Comb. Wrench	1
KTI41334	1 1/16" High Polish Comb. Wrench	1
KTI41336	1 1/8" High Polish Comb. Wrench	1
KTI41340	1 1/4" High Polish Comb. Wrench	1
KTI41412	6Pt Combination Wrench 3/8"	1
KTI41414	6Pt Combination Wrench 7/16"	1
KTI41416	6Pt Combination Wrench 1/2"	1
KTI41418	6Pt Combination Wrench 9/16"	1
KTI41420	6Pt Combination Wrench 5/8"	1
KTI41422	6Pt Combination Wrench 11/16"	1
KTI41424	6Pt Combination Wrench 3/4"	1
KTI089	Extension Bar	1
KTIHOOK2	Hooks	28
KTIHOOK11	Hooks-Plastic	16
KTIOL0812	Display Overlay	1
KTIOLF-04333	Overlay Fasteners (6 Pack)	1

KTI0813

Metric Wrenches		Qty
KTI41608	Metric Comb Wrench 8mm	1
KTI41609	Metric Comb Wrench 9mm	1
KTI41610	Metric Comb Wrench 10mm	2
KTI41611	Metric Comb Wrench 11mm	2
KTI41612	Metric Comb Wrench 12mm	2
KTI41613	Metric Comb Wrench 13mm	2

KTI0813

Metric Wrenches (continued)		Qty
KTI41614	Metric Comb Wrench 14mm	2
KTI41615	Metric Comb Wrench 15mm	2
KTI41616	Metric Comb Wrench 16mm	1
KTI41617	Metric Comb Wrench 17mm	1
KTI41618	Metric Comb Wrench 18mm	1
KTI41619	Metric Comb Wrench 19mm	1
KTI41710	10mm Short Combination Wrench	1
KTI41712	12mm Short Combination Wrench	1
KTI41713	13mm Short Combination Wrench	1
KTI41714	14mm Short Combination Wrench	1
KTI41715	15mm Short Combination Wrench	1
KTI41717	17mm Short Combination Wrench	1
KTI41718	18mm Short Combination Wrench	1
KTI41807	7mm High Polish Comb. Wrench	1
KTI41808	8mm High Polish Comb. Wrench	1
KTI41809	9mm High Polish Comb. Wrench	1
KTI41810	10mm High Polish Comb. Wrench	2
KTI41811	11mm High Polish Comb. Wrench	1
KTI41812	12mm High Polish Comb. Wrench	2
KTI41813	13mm High Polish Comb. Wrench	2
KTI41814	14mm High Polish Comb. Wrench	1
KTI41815	15mm High Polish Comb. Wrench	2
KTI41816	16mm High Polish Comb. Wrench	1
KTI41817	17mm High Polish Comb. Wrench	1
KTI41818	18mm High Polish Comb. Wrench	2
KTI41819	19mm High Polish Comb. Wrench	1
KTI41820	Metric Comb Wrench 20mm (Bulk)	1
KTI41821	Metric Comb Wrench 21mm (Bulk)	1
KTI41822	Metric Comb Wrench 22mm (Bulk)	1
KTI41823	Metric Comb Wrench 23mm (Bulk)	1
KTI41824	Metric Comb Wrench 24mm (Bulk)	1
KTI41825	Metric Comb Wrench 25mm (Bulk)	1
KTI41826	Metric Comb Wrench 26mm (Bulk)	1
KTI41827	Metric Comb Wrench 27mm (Bulk)	1
KTI41828	Metric Comb Wrench 28mm (Bulk)	1
KTI41829	Metric Comb Wrench 29mm (Bulk)	1
KTI41830	Metric Comb Wrench 30mm (Bulk)	1
KTI41831	Metric Comb Wrench 31mm (Bulk)	1
KTI41832	Metric Comb Wrench 32mm (Bulk)	1
KTI41833	Metric Comb Wrench 33mm (Bulk)	1
KTI41834	Metric Comb Wrench 34mm (Bulk)	1
KTI41835	Metric Comb Wrench 35mm (Bulk)	1
KTI41836	Metric Comb Wrench 36mm (Bulk)	1
KTI089	Extension Bar	1
KTIHOOK11	Hooks-Plastic	17
KTIHOOK2	Hooks	32
KTIOL0813	Display Overlay	1
KTIOLF-04333	Overlay Fasteners (6 Pack)	1

KTI0814

Jumbo Wrenches		Qty
KTI41144	Jumbo Combo Wrench 1-3/8"	1
KTI41146	Jumbo Combo Wrench 1-7/16"	1
KTI41148	Jumbo Combo Wrench 1-1/2"	1
KTI41152	Jumbo Combo Wrench 1-5/8"	1
KTI41156	Jumbo Combo Wrench 1-3/4"	1
KTI41160	Jumbo Combo Wrench 1-7/8"	1
KTI41164	Jumbo Combo Wrench 2"	1
KTI41168	Jumbo Combo Wrench 2-1/8 (Bulk)	1
KTI41172	Jumbo Combo Wrench 2-1/4 (Bulk)	1
KTI41176	Jumbo Combo Wrench 2-3/8 (Bulk)	1
KTI41180	Jumbo Combo Wrench 2-1/2 (Bulk)	1
KTI089	Extension Bar	1
KTIHOOK11	Hooks-Plastic	5
KTIHOOK2	Hooks	6
KTIOL0814	Display Overlay	1
KTIOLF-04333	Overlay Fasteners (6 Pack)	1

Displays and Merchandisers

KTI0815

Nylon Ties		Qty
KTI76000	Nylon Tie Tool	1
KTI76040	4" Cable Tie Natural 100 Pack	2
KTI76070	7" Cable Tie Natural 100 Pack	2
KTI76110	11" Cable Tie Natural 100 Pack	2
KTI76140	14" Cable Tie Natural 100 Pack	2
KTI76145	14"Hd Cable Tie Natur.100 Pack	1
KTI77070	7.5" Natural Mt.Head 100 Pack	1
KTI77140	14" Natural Mt.Head 100 Pack	1
KTI78040	4" Cable Tie Black 100 Pack	2
KTI78070	7" Cable Tie Black 100 Pack	2
KTI78110	11" Cable Tie Black 100 Pack	2
KTI78140	14" Cable Tie Black 100 Pack	2
KTI78145	14"Hd Cable Tie Black 100 Pack	1
KTIHOOK2	Hooks	8
KTIOL0815	Display Overlay	1
KTIOLF-04333	Overlay Fasteners (6 Pack)	1

KTI0816

Pliers		Qty
KTI51006	6" Needle Nose Chrome Vanadium	1
KTI51007	7" Needle Nose Chrome Vanadium	1
KTI51008	8" Needle Nose Chrome Vanadium	1
KTI51111	11" Needle Nose Plier 90 Deg.	1
KTI51211	11" Needle Nose Plier 45 Deg.	1
KTI51311	11" Needle Nose Plier "S"	1
KTI52006	6" Diagonals Chrome Vanadium	1
KTI52007	7" Diagonals Chrome Vanadium	1
KTI52107	7" H.D. Diagonals Chrome Van.	1
KTI53004	4" Chrome Pliers Red Handles	1
KTI53006	6" Chrome Pliers Red Handles	1
KTI53008	8" Chrome Pliers Red Handles	1
KTI54006	6" Groove Joint Plier	1
KTI54010	10" Groove Joint Plier	1
KTI54012	12" Groove Joint Plier	1
KTIHOOK2	Hooks	15
KTIOL0816	Display Overlay	1
KTIOLF-04333	Overlay Fasteners (6 Pack)	1

KTI0817

Adjustable Wrenches		Qty
KTI48004	4" Adjustable Wrench	1
KTI48006	6" Adjustable Wrench	1
KTI48008	8" Adjustable Wrench	1
KTI48010	10" Adjustable Wrench	1
KTI48012	12" Adjustable Wrench	1
KTI49008	8" Pipe Wrench	1
KTI49010	10" Pipe Wrench	1
KTI49012	12" Pipe Wrench	1
KTI49014	14" Pipe Wrench	1
KTI49018	18" Pipe Wrench	1
KTI49024	24" Pipe Wrench	1
KTIHOOK2	Hooks	11
KTIOL0817	Display Overlay	1
KTIOLF-04333	Overlay Fasteners (6 Pack)	1

KTI0819

Files and Scrapers		Qty
KTI70020	Long Handled Scraper	1
KTI70023	4 Pc Scraper Set - USA	1
KTI70024	3/4 Chisel Edge Stiff Scraper	1
KTI70025	1 1/2" Flexible Scraper	1
KTI70026	1 1/2" Chisel Edge Stiff Scraper	1
KTI70029	3" Flex Scraper	1
KTI72505	File Set 5 Piece	1
KTI72512	6" Mill File	1
KTI72514	10" Mill File	1
KTI72523	8" Bastard File	1
KTI72543	8" Half Round File	1
KTI72553	8" Round File	1
KTIHOOK2	Hooks	13
KTIOL0819	Display Overlay	1
KTIOLF-04333	Overlay Fasteners (6 Pack)	1

KTI0820

Hammers		Qty
KTI71700	3/8" Dr Impact Driver W/4 Bits	1
KTI71708	8 Oz. Ball Pein Hammer	1
KTI71715	24 Oz.Brass Hammer,Hickory	1
KTI71716	16 Oz. Ball Pein Hammer	1
KTI71724	4 Lb. Cross-Pein Hammer	1
KTI71725	24 Oz. Ball Pein Hammer	1
KTI71732	32 Oz. Ball Pein Hammer	1
KTI71751	24 Oz. Rubber Mallet	1
KTI71783	48 Oz. Solid Brass Hammer	1
KTIHOOK2	Hooks	18
KTIOL0820	Display Overlay	1
KTIOLF-04333	Overlay Fasteners (6 Pack)	1

KTI0821

Snap Ring Pliers		Qty
KTI55112	12 Pc. Kit Universal Snap Ring	1
KTI55120	Fixed Tip Convertible Pliers S.	1
KTI55121	Fixed Tip Convertible Pliers S.	1
KTI55122	Fixed Tip Convertible Pliers S.	1
KTI55123	Fixed Tip Convertible Pliers S.	1
KTI55130	Fixed Tip Convertible Pliers 4.	1
KTI55131	Fixed Tip Convertible Pliers 4.	1
KTI55132	Fixed Tip Convertible Pliers 4.	1
KTI55133	Fixed Tip Convertible Pliers 4.	1
KTI55140	Fixed Tip Convertible Pliers 9.	1
KTI55141	Fixed Tip Convertible Pliers 9.	1
KTI55142	Fixed Tip Convertible Pliers 9.	1
KTI55143	Fixed Tip Convertible Pliers 9.	1
KTIHOOK2	Hooks	14
KTIOL0821	Display Overlay	1
KTIOLF-04333	Overlay Fasteners (6 Pack)	1

KTI0822

Tie Downs and Tow Straps		Qty
KTI73801	1 7/8" X 10' Tow Strap 7000Lbs	1
KTI73802	1 3/4" X 15' Tow Strap 10,000Lb	1
KTI73803	1 3/4" X 25' Tow Strap 10,000Lb	1
KTI73861	1" X 13' Ratchet Tie Down,Hook	1
KTI73862	1" X 13' Ratchet Tie Down,Loop	1
KTI73864	1" X 6' Motorcycle Tie Down	1
KTI73870	4 Pack 1" X 10' Ratch.Tie Down	1
KTI73871	1" X 10' Universal Tie Down	1
KTI73873	2 Pack 1" X 13'Buckle Tie Down	1
KTIHOOK2	Hooks	12
KTIOL0822	Display Overlay	1
KTIOLF-04333	Overlay Fasteners (6 Pack)	1

KTI0831

Punches and Chisels		Qty
KTI70002	Automatic Center Punch	2
KTI72900	6 Pc Pin Punch Set	1
KTI72901	15Pc Punch & Chisel Set	1
KTI72911	3/32" Pin Punch	1
KTI72912	1/8" Pin Punch	1
KTI72913	5/32" Pin Punch	1
KTI72914	3/16" Pin Punch	1
KTI72915	1/4" Pin Punch	1
KTI72916	5/16" Pin Punch	1
KTI72921	3/32" Taper Punch	1
KTI72922	1/8" Taper Punch	1
KTI72923	5/32" Taper Punch	1
KTI72924	3/16" Taper Punch	1
KTI72925	1/4" Taper Punch	1
KTI72931	1/8" Center Punch	1
KTI72932	3/16" Center Punch	1
KTI72982	3/8" Brass Punch	1
KTI72984	1/2" Brass Punch	1
KTI72986	5/8" Brass Punch	1
KTI72988	3/4" Brass Punch	1
KTI73000	5 Pc Chisel Set	1
KTI73012	3/8" Cold Chisel	1

KTIO831

Punches and Chisels (continued)	Qty
KT1730161/2" Cold Chisel.....	1
KT1730205/8" Cold Chisel.....	1
KT1730243/4" Cold Chisel.....	1
KT1730287/8" Cold Chisel.....	1
KTIH00K2Hooks.....	29
KTIOL0831Display Overlay.....	1
KTIOLF-04333Overlay Fasteners (6 Pack).....	1

KTIO832

Pneumatic Bits	Qty
KT1819004 Pc. Pneumatic Bit Set.....	1
KT181956Double Cut Body Ripper.....	1
KT181958Slotted Panel Cutter.....	2
KT181959Sheet Metal Trimmer.....	2
KT181968Tail Pipe Cut Off.....	1
KT1819726" Cold Chisel.....	2
KT1819738" Cold Chisel.....	1
KT181975Rivet & Bolt Cutter.....	2
KT181976Scraper.....	1
KT1819793/8" Taper Punch.....	2
KT181981Hammer.....	2
KT181982Hammer.....	1
KT181995Tie Rod Separator-Pneumatic.....	1
KT181996Ball Joint Separator-Pneumatic.....	1
KT1819971/8" Taper Punch.....	2
KT183091Spring Retainer For Air Tools.....	2
KT183092Safety Chuck.....	1
KT183093Quick Coupler Retainer.....	1
KTIH00K2Hooks.....	19
KTIOL0832Display Overlay.....	1
KTIOLF-04333Overlay Fasteners (6 Pack).....	1

KTIO833

Pullers	Qty
KT1703114" Two Jaw Adjustable Puller.....	1
KT1703126" Two Jaw Reversible Puller.....	1
KT1703137" Two Jaw Adjustable Puller.....	1
KT1703214" Three Jaw Adjustable Puller.....	1
KT1703227" 2-3 Jaw Reversible Puller.....	1
KT1703238" 2-3 Jaw Adjustable Puller.....	1
KT170330Steering Wheel Puller - USA.....	1
KT170344Harmonic Balancer Puller - USA.....	1
KT170365Pitman Arm Puller - USA.....	1
KT170383Bearing Separator 1-1/4" - 2-1/4".....	1
KT170384Bearing Separator 3" - 4-1/2".....	1
KTIH00K2Hooks.....	12
KTIOL0833Display Overlay.....	1
KTIOLF-04333Overlay Fasteners (6 Pack).....	1

KTIO834

Popular Tools I	Qty
KT1210021/4" Dr 2" Extension.....	1
KT1210041/4" Dr 4" Extension.....	1
KT1210061/4" Dr 6" Extension.....	1
KT121050Universal Joint 1/4" Dr.....	1
KT121055Adapter 1/4" F X 3/8" M.....	1
KT1210601/4" Dr Spinner Handle.....	1
KT1210911/4" Dr Ratchet.....	1
KT1210921/4" Dr Pro Ratchet.....	1
KT1211061/4" Dr Short Socket 3/16".....	1
KT1211071/4" Dr Short Socket 7/32".....	1
KT1211081/4" Dr Short Socket 1/4".....	1
KT1211091/4" Dr Short Socket 9/32".....	1
KT1211101/4" Dr Short Socket 5/16".....	1
KT1211111/4" Dr Short Socket 11/32".....	1
KT1211121/4" Dr Short Socket 3/8".....	1
KT1211141/4" Dr Short Socket 7/16".....	1
KT1211161/4" Dr Short Socket 1/2".....	1
KT1211181/4" Dr Short Socket 9/16".....	1
KT1212061/4" Dr Deep Socket 3/16".....	1
KT1212071/4" Dr Deep Socket 7/32".....	1
KT1212081/4" Dr Deep Socket 1/4".....	1

KTIO834

Popular Tools I (continued)	Qty
KT1212091/4" Dr Deep Socket 9/32".....	1
KT1212101/4" Dr Deep Socket 5/16".....	1
KT1212111/4" Dr Deep Socket 11/32".....	1
KT1212121/4" Dr Deep Socket 3/8".....	1
KT1212141/4" Dr Deep Socket 7/16".....	1
KT1212161/4" Dr Deep Socket 1/2".....	1
KT1212181/4" Dr Deep Socket 9/16".....	1
KT1220033/8" Dr Extension 3".....	1
KT1220063/8" Dr Extension 6".....	1
KT1220083/8" Dr Extension 8".....	1
KT122050Adapter 1/2" F X 3/8" M.....	1
KT122055Adapter 3/8" F X 1/2" M.....	1
KT122060Adapter 3/8" F X 1/4" M.....	1
KT122075Adapter 1/2" F X 3/4" M.....	1
KT1220913/8" Dr Push Button Ratchet.....	1
KT1220923/8" Dr Pro Ratchet.....	1
KT1221103/8" Dr Short Socket 5/16".....	1
KT1221123/8" Dr Short Socket 3/8".....	1
KT1221143/8" Dr Short Socket 7/16".....	1
KT1221163/8" Dr Short Socket 1/2".....	1
KT1221183/8" Dr Short Socket 9/16".....	1
KT1221203/8" Dr Short Socket 5/8".....	1
KT1221223/8" Dr Short Socket 11/16".....	1
KT1221243/8" Dr Short Socket 3/4".....	1
KT1221263/8" Dr Short Socket 13/16".....	1
KT1221283/8" Dr Short Socket 7/8".....	1
KT1221303/8" Dr Short Socket 15/16".....	1
KT1221323/8" Dr Short Socket 1".....	1
KT1222123/8" Dr Deep Socket 3/8".....	1
KT1222143/8" Dr Deep Socket 7/16".....	1
KT1222163/8" Dr Deep Socket 1/2".....	1
KT1222183/8" Dr Deep Socket 9/16".....	1
KT1222203/8" Dr Deep Socket 5/8".....	1
KT1222223/8" Dr Deep Socket 11/16".....	1
KT1222243/8" Dr Deep Socket 3/4".....	1
KT1222263/8" Dr Deep Socket 13/16".....	1
KT1222283/8" Dr Deep Socket 7/8".....	1
KT1222303/8" Dr Deep Socket 15/16".....	1
KT1222323/8" Dr Deep Socket 1".....	1
KT122500Universal Joint 3/8" Dr.....	1
KT1230031/2" Dr 3" Extension.....	1
KT1230051/2" Dr 5" Extension.....	1
KT1230101/2" Dr 10" Extension.....	1
KT1230911/2" Dr Push Button Ratchet.....	1
KT1230921/2" Dr Pro Ratchet.....	1
KT1231161/2" Dr Short Socket 1/2".....	1
KT1231181/2" Dr Short Socket 9/16".....	1
KT1231201/2" Dr Short Socket 5/8".....	1
KT1231221/2" Dr Short Socket 11/16".....	1
KT1231241/2" Dr Short Socket 3/4".....	1
KT1231261/2" Dr Short Socket 13/16".....	1
KT1231281/2" Dr Short Socket 7/8".....	1
KT1231301/2" Dr Short Socket 15/16".....	1
KT1231321/2" Dr Short Socket 1".....	1
KT1231341/2" Dr Short Socket 1-1/16".....	1
KT1231361/2" Dr Short Socket 1-1/8".....	1
KT1231401/2" Dr Short Socket 1-1/4".....	1
KT1232161/2" Dr Deep Socket 1/2".....	1
KT1232181/2" Dr Deep Socket 9/16".....	1
KT1232201/2" Dr Deep Socket 5/8".....	1
KT1232221/2" Dr Deep Socket 11/16".....	1
KT1232241/2" Dr Deep Socket 3/4".....	1
KT1232261/2" Dr Deep Socket 13/16".....	1
KT1232281/2" Dr Deep Socket 7/8".....	1
KT1232301/2" Dr Deep Socket 15/16".....	1
KT1232321/2" Dr Deep Socket 1".....	1
KT1232341/2" Dr Deep Socket 1-1/16".....	1
KT1232361/2" Dr Deep Socket 1-1/8".....	1
KT1232401/2" Dr Deep Socket 1-1/4".....	1
KT123500Universal Joint 1/2" Dr.....	1
KTI089Extension Bar.....	1
KTIH00K2Hooks.....	47
KTIH00K11Small Plastic Hook.....	11

Displays and Merchandisers

KTI0834

Popular Tools I (continued)		Qty
KTIOL0834	Display Overlay	1
KTIOLF-04333	Overlay Fasteners (6 Pack)	1

KTI0835

Popular Tools II		Qty
KTI22221	Spark Plug Socket 3/8" Dr 5/8"	1
KTI22227	Spark Plug Socket 3/8" Dr 13/16"	1
KTI26105	1/4" Dr Short Socket 5mm	1
KTI26106	1/4" Dr Short Socket 6mm	1
KTI26107	1/4" Dr Short Socket 7mm	1
KTI26108	1/4" Dr Short Socket 8mm	1
KTI26109	1/4" Dr Short Socket 9mm	1
KTI26110	1/4" Dr Short Socket 10mm	1
KTI26111	1/4" Dr Short Socket 11mm	1
KTI26112	1/4" Dr Short Socket 12mm	1
KTI26113	1/4" Dr Short Socket 13mm	1
KTI26114	1/4" Dr Short Socket 14mm	1
KTI26115	1/4" Dr Short Socket 15mm	1
KTI26155	1/4" Dr Short Socket 5.5mm	1
KTI26206	1/4" Dr Deep Socket 6mm	1
KTI26207	1/4" Dr Deep Socket 7mm	1
KTI26208	1/4" Dr Deep Socket 8mm	1
KTI26209	1/4" Dr Deep Socket 9mm	1
KTI26210	1/4" Dr Deep Socket 10mm	1
KTI26211	1/4" Dr Deep Socket 11mm	1
KTI26212	1/4" Dr Deep Socket 12mm	1
KTI26213	1/4" Dr Deep Socket 13mm	1
KTI26214	1/4" Dr Deep Socket 14mm	1
KTI26215	1/4" Dr Deep Socket 15mm	1
KTI26255	1/4" Dr Deep Socket 5.5mm	1
KTI27108	3/8" Dr Short Socket 8mm	1
KTI27109	3/8" Dr Short Socket 9mm	1
KTI27110	3/8" Dr Short Socket 10mm	1
KTI27111	3/8" Dr Short Socket 11mm	1
KTI27112	3/8" Dr Short Socket 12mm	1
KTI27113	3/8" Dr Short Socket 13mm	1
KTI27114	3/8" Dr Short Socket 14mm	1
KTI27115	3/8" Dr Short Socket 15mm	1
KTI27116	3/8" Dr Short Socket 16mm	1
KTI27117	3/8" Dr Short Socket 17mm	1
KTI27118	3/8" Dr Short Socket 18mm	1
KTI27119	3/8" Dr Short Socket 19mm	1
KTI27210	3/8" Dr Deep Socket 10mm	1
KTI27211	3/8" Dr Deep Socket 11mm	1
KTI27212	3/8" Dr Deep Socket 12mm	1
KTI27213	3/8" Dr Deep Socket 13mm	1
KTI27214	3/8" Dr Deep Socket 14mm	1
KTI27215	3/8" Dr Deep Socket 15mm	1
KTI27216	3/8" Dr Deep Socket 16mm	1
KTI27217	3/8" Dr Deep Socket 17mm	1
KTI27218	3/8" Dr Deep Socket 18mm	1
KTI27219	3/8" Dr Deep Socket 19mm	1
KTI28110	1/2" Dr Short Socket 10mm	1
KTI28111	1/2" Dr Short Socket 11mm	1
KTI28112	1/2" Dr Short Socket 12mm	1
KTI28113	1/2" Dr Short Socket 13mm	1
KTI28114	1/2" Dr Short Socket 14mm	1
KTI28115	1/2" Dr Short Socket 15mm	1
KTI28116	1/2" Dr Short Socket 16mm	1
KTI28117	1/2" Dr Short Socket 17mm	1
KTI28118	1/2" Dr Short Socket 18mm	1
KTI28119	1/2" Dr Short Socket 19mm	1
KTI28120	1/2" Dr Short Socket 20mm	1
KTI28121	1/2" Dr Short Socket 21mm	1
KTI28210	1/2" Dr Deep Socket 10mm	1
KTI28211	1/2" Dr Deep Socket 11mm	1
KTI28212	1/2" Dr Deep Socket 12mm	1
KTI28213	1/2" Dr Deep Socket 13mm	1
KTI28214	1/2" Dr Deep Socket 14mm	1
KTI28215	1/2" Dr Deep Socket 15mm	1
KTI28216	1/2" Dr Deep Socket 16mm	1
KTI28217	1/2" Dr Deep Socket 17mm	1
KTI28218	1/2" Dr Deep Socket 18mm	1

KTI0835

Popular Tools II (continued)		Qty
KTI28219	1/2" Dr Deep Socket 19mm	1
KTI28220	1/2" Dr Deep Socket 20mm	1
KTI28221	1/2" Dr Deep Socket 21mm	1
KTI41108	Combination Wrench 1/4"	1
KTI41110	Combination Wrench 5/16"	1
KTI41112	Combination Wrench 3/8"	2
KTI41114	Combination Wrench 7/16"	2
KTI41116	Combination Wrench 1/2"	3
KTI41118	Combination Wrench 9/16"	3
KTI41120	Combination Wrench 5/8"	2
KTI41122	Combination Wrench 11/16"	1
KTI41124	Combination Wrench 3/4"	2
KTI41126	Combination Wrench 13/16"	1
KTI41128	Combination Wrench 7/8"	1
KTI41130	Combination Wrench 15/16"	1
KTI41132	Combination Wrench 1"	1
KTI41134	Combination Wrench 1-1/16"	1
KTI41136	Combination Wrench 1-1/8"	1
KTI41608	Combination Wrench 8mm	1
KTI41609	Combination Wrench 9mm	1
KTI41610	Combination Wrench 10mm	2
KTI41611	Combination Wrench 11mm	2
KTI41612	Combination Wrench 12mm	2
KTI41613	Combination Wrench 13mm	2
KTI41614	Combination Wrench 14mm	2
KTI41615	Combination Wrench 15mm	2
KTI41616	Combination Wrench 16mm	2
KTI41617	Combination Wrench 17mm	2
KTI41618	Combination Wrench 18mm	2
KTI41619	Combination Wrench 19mm	2
KTI44412	3/8" X 7/16" Flare Nut Wrench	1
KTI44416	1/2" X 9/16" Flare Nut Wrench	1
KTI44420	5/8" X 11/16" Flare Nut Wrench	1
KTI089	Extension Bar	1
KTIHOOK2	Hooks	57
KTIHOOK11	Small Plastic Hook	14
KTIOL0835	Display Overlay	1
KTIOLF-04333	Overlay Fasteners (6 Pack)	1

KTI0836

Nut Drivers and Hex Keys		Qty
KTI14400	7-Piece Fractional Nut Driver Set	1
KTI14406	3/16" X 3" Fractional Nut Driver	1
KTI14408	1/4" X 3" Fractional Nut Driver	1
KTI14410	5/16" X 3" Fractional Nut Driver	1
KTI14411	11/32" X 3" Fractional Nut Driver	1
KTI14412	3/8" X 3" Fractional Nut Driver	1
KTI14414	7/16" X 3" Fractional Nut Driver	1
KTI14416	1/2" X 3" Fractional Nut Driver	1
KTI14500	7-Piece Metric Nut Driver Set	1
KTI14505	5mm X 75 Metric Nut Driver	1
KTI14506	6mm X 75 Metric Nut Driver	1
KTI14507	7mm X 75 Metric Nut Driver	1
KTI14508	8mm X 75 Metric Nut Driver	1
KTI14509	9mm X 75 Metric Nut Driver	1
KTI14510	10mm X 75 Metric Nut Driver	1
KTI14511	11mm X 75 Metric Nut Driver	1
KTI70040	Spiral Extractor Set	1
KTI70070	4-Piece Pick Set (Neon Orange)	1
KTI70075	4-Piece Pick Set (Neon Green)	1
KTI71400	Hex Key Set 1/8" - 3/8" Folding	1
KTI71420	Hex Key Set 1/16" - 3/8" on Ring	1
KTI71475	Hex Key Set 2.5mm - 10mm Folding	1
KTI71480	Hex Key Set 1.5mm - 10mm on Ring	1
KTIHOOK2	Hooks	20
KTIOL0836	Display Overlay	1
KTIOLF-04333	Overlay Fasteners (6 Pack)	1

KTI0837

Oil Filter Wrenches	Qty	
KTI73600	4-In-1 Filter Wrench	1
KTI73601	Oil Filter Wrench Adj From 2-7/8"-3-1/4"	1
KTI73602	Oil Filter Wrench Adj From 3-7/16"-3-3/4"	1
KTI73603	Oil Filter Wrench Adj From 4"-4-3/8"	1
KTI73605	Oil Filter Wrench Adj From 4-5/16"-4-3/4"	1
KTI73606	Oil Filter Wrench Adj From 5-1/4"-5-3/4"	1
KTI73613	Cap Style Filter Wrench 65mm/14 Flute	1
KTI73614	Cap Style Filter Wrench 74-76mm/15 Flute	1
KTI73615	Cap Style Filter Wrench 76mm/14 Flute	1
KTI73616	Cap Style Filter Wrench 93mm/15 Flute	1
KTI73618	Oil Filter Cap Socket 32mm	1
KTI73619	Oil Filter Cap Socket 35-36mm	1
KTI73620	Oil Filter Pliers - Adjustable	1
KTI73730	Filter Wrench Nylon Strap 1/2"	1
KTI73731	Heavy-Duty Strap Oil Filter Wrench	1
KTIOL0837	Overlay 0837	1
KTIOLF-04333	Overlay Fasteners (6 Pack)	1
KTI089	.3" Extension Bar	1
KTIH00K2	Hooks	9
KTIH00K11	Plastic Hooks	6

KTI0838

Pullers and Separators	Qty	
KTI70301	.3" Two-Jaw Two-Ton Puller	1
KTI70302	.3" Two/Three-Jaw Two-Ton Puller	1
KTI70303	.4" Two-Jaw Five-Ton Puller	1
KTI70304	.3" Two/Three-Jaw Five-Ton Puller	1
KTI70305	.6" Two-Jaw Five-Ton Puller	1
KTI70306	.6" Two/Three-Jaw Five-Ton Puller	1
KTI70348	Steering Wheel Puller	1
KTI70383	Bearing Separator 1 1/4"-2 1/4"	1
KTI70384	Bearing Separator 3"-4 1/2"	1
KTIH00K2	Hooks	9
KTIOL0838	Overlay 0838	1
KTIOLF-04333	Overlay Fasteners (6 Pack)	1

KTI0839

Impact Sockets	Qty	
KTI32012	Impact Universal Joint 3/8" Drive	1
KTI32016	.3/8" Female X 1/2" Male Impact Adapter	1
KTI32110	Socket Impact 3/8" Drive 5/16"	1
KTI32112	Socket Impact 3/8" Drive 3/8"	1
KTI32114	Socket Impact 3/8" Drive 7/16"	1
KTI32116	Socket Impact 3/8" Drive 1/2"	1
KTI32118	Socket Impact 3/8" Drive 9/16"	1
KTI32120	Socket Impact 3/8" Drive 5/8"	1
KTI32122	Socket Impact 3/8" Drive 11/16"	1
KTI32124	Socket Impact 3/8" Drive 3/4"	1
KTI32126	Socket Impact 3/8" Drive 13/16"	1
KTI32128	Socket Impact 3/8" Drive 7/8"	1
KTI32210	Socket Impact Deep 3/8" Drive 5/16"	1
KTI32212	Socket Impact Deep 3/8" Drive 3/8"	1
KTI32214	Socket Impact Deep 3/8" Drive 7/16"	1
KTI32216	Socket Impact Deep 3/8" Drive 1/2"	1
KTI32218	Socket Impact Deep 3/8" Drive 9/16"	1
KTI32220	Socket Impact Deep 3/8" Drive 5/8"	1
KTI32222	Socket Impact Deep 3/8" Drive 11/16"	1
KTI32224	Socket Impact Deep 3/8" Drive 3/4"	1
KTI32226	Socket Impact Deep 3/8" Drive 13/16"	1
KTI32228	Socket Impact Deep 3/8" Drive 7/8"	1
KTI33003	1/2" Drive Impact Extension 3-Inch	1
KTI33006	1/2" Drive Impact Extension 6-Inch	1
KTI33012	1/2" Female X 3/8" Male Impact Adapter	1
KTI33016	1/2" Drive Universal Joint Impact	1
KTI33024	1/2" Female X 3/4" Male Impact Adapter	1
KTI33041	1/2" Female X 3/8" Male Wobble Adapter	1
KTI33050	Socket Impact 1/2" Drive Flip 3/4" X 13/16"	1
KTI33112	Socket 1/2" Drive Short Impact 3/8"	1
KTI33114	Socket 1/2" Drive Short Impact 7/16"	1
KTI33116	Socket 1/2" Drive Short Impact 1/2"	1
KTI33118	Socket 1/2" Drive Short Impact 9/16"	1
KTI33120	Socket 1/2" Drive Short Impact 5/8"	1

KTI0839

Impact Sockets (continued)	Qty	
KTI33122	Socket 1/2" Drive Short Impact 11/16"	1
KTI33124	Socket 1/2" Drive Short Impact 3/4"	1
KTI33126	Socket 1/2" Drive Short Impact 13/16"	1
KTI33128	Socket 1/2" Drive Short Impact 7/8"	1
KTI33130	Socket 1/2" Drive Short Impact 15/16"	1
KTI33132	Socket 1/2" Drive Short Impact 1"	1
KTI33134	Socket 1/2" Drive Short Impact 1-1/16"	1
KTI33136	Socket 1/2" Drive Short Impact 1-1/8"	1
KTI33138	Socket 1/2" Drive Short Impact 1-3/16"	1
KTI33140	Socket 1/2" Drive Short Impact 1-1/4"	1
KTI33142	Socket 1/2" Drive Short Impact 1-5/16"	1
KTI33144	Socket 1/2" Drive Short Impact 1-3/8"	1
KTI33146	Socket 1/2" Drive Short Impact 1-7/16"	1
KTI33148	Socket 1/2" Drive Short Impact 1-1/2"	1
KTI33212	Socket 1/2" Drive Impact Deep 3/8"	1
KTI33214	Socket 1/2" Drive Impact Deep 7/16"	1
KTI33216	Socket 1/2" Drive Impact Deep 1/2"	1
KTI33218	Socket 1/2" Drive Impact Deep 9/16"	1
KTI33220	Socket 1/2" Drive Impact Deep 5/8"	1
KTI33222	Socket 1/2" Drive Impact Deep 11/16"	1
KTI33224	Socket 1/2" Drive Impact Deep 3/4"	1
KTI33226	Socket 1/2" Drive Impact Deep 13/16"	1
KTI33228	Socket 1/2" Drive Impact Deep 7/8"	1
KTI33230	Socket 1/2" Drive Impact Deep 15/16"	1
KTI33232	Socket 1/2" Drive Impact Deep 1"	1
KTI33234	Socket 1/2" Drive Impact Deep 1-1/16"	1
KTI33236	Socket 1/2" Drive Impact Deep 1-1/8"	1
KTI33238	Socket 1/2" Drive Impact Deep 1-3/16"	1
KTI33240	Socket 1/2" Drive Impact Deep 1-1/4"	1
KTI33242	Socket 1/2" Drive Impact Deep 1-5/16"	1
KTI33244	Socket 1/2" Drive Impact Deep 1-3/8"	1
KTI33246	Socket 1/2" Drive Impact Deep 1-7/16"	1
KTI33248	Socket 1/2" Drive Impact Deep 1-1/2"	1
KTI34016	3/4" Female X 1/2" Male Impact Adapter	1
KTI37108	Socket Impact Metric Short 3/8" Drive 8mm	1
KTI37109	Socket Impact Metric Short 3/8" Drive 9mm	1
KTI37110	Socket Impact Metric Short 3/8" Drive 10mm	1
KTI37111	Socket Impact Metric Short 3/8" Drive 11mm	1
KTI37112	Socket Impact Metric Short 3/8" Drive 12mm	1
KTI37113	Socket Impact Metric Short 3/8" Drive 13mm	1
KTI37114	Socket Impact Metric Short 3/8" Drive 14mm	1
KTI37115	Socket Impact Metric Short 3/8" Drive 15mm	1
KTI37116	Socket Impact Metric Short 3/8" Drive 16mm	1
KTI37117	Socket Impact Metric Short 3/8" Drive 17mm	1
KTI37118	Socket Impact Metric Short 3/8" Drive 18mm	1
KTI37119	Socket Impact Metric Short 3/8" Drive 19mm	1
KTI37208	Socket Deep Impact 3/8" Drive 8mm	1
KTI37209	Socket Deep Impact 3/8" Drive 9mm	1
KTI37210	Socket Deep Impact 3/8" Drive 10mm	1
KTI37211	Socket Deep Impact 3/8" Drive 11mm	1
KTI37212	Socket Deep Impact 3/8" Drive 12mm	1
KTI37213	Socket Deep Impact 3/8" Drive 13mm	1
KTI37214	Socket Deep Impact 3/8" Drive 14mm	1
KTI37215	Socket Deep Impact 3/8" Drive 15mm	1
KTI37216	Socket Deep Impact 3/8" Drive 16mm	1
KTI37217	Socket Deep Impact 3/8" Drive 17mm	1
KTI37218	Socket Deep Impact 3/8" Drive 18mm	1
KTI37219	Socket Deep Impact 3/8" Drive 19mm	1
KTI38050	Socket Impact 1/2" Drive Flip 19mm X 21mm	1
KTI38110	Socket 1/2" Drive Short Impact 10mm	1
KTI38111	Socket 1/2" Drive Short Impact 11mm	1
KTI38112	Socket 1/2" Drive Short Impact 12mm	1
KTI38113	Socket 1/2" Drive Short Impact 13mm	1
KTI38114	Socket 1/2" Drive Short Impact 14mm	1
KTI38115	Socket 1/2" Drive Short Impact 15mm	1
KTI38116	Socket 1/2" Drive Short Impact 16mm	1
KTI38117	Socket 1/2" Drive Short Impact 17mm	1
KTI38118	Socket 1/2" Drive Short Impact 18mm	1
KTI38119	Socket 1/2" Drive Short Impact 19mm	1
KTI38120	Socket 1/2" Drive Short Impact 20mm	1
KTI38121	Socket 1/2" Drive Short Impact 21mm	1
KTI38122	Socket Impact Metric 1/2" Drive 22mm	1
KTI38123	Socket Impact Metric 1/2" Drive 23mm	1

Displays and Merchandisers

KTI0839

Impact Sockets (continued)	Qty	
KTI38124	Socket Impact Metric 1/2" Drive 24mm	1
KTI38125	Socket Impact Metric 1/2" Drive 25mm	1
KTI38126	Socket Impact Metric 1/2" Drive 26mm	1
KTI38127	Socket Impact Metric 1/2" Drive 27mm	1
KTI38128	Socket Impact Metric 1/2" Drive 28mm	1
KTI38129	Socket Impact Metric 1/2" Drive 29mm	1
KTI38130	Socket Impact Metric 1/2" Drive 30mm	1
KTI38132	Socket Impact Metric 1/2" Drive 32mm	1
KTI38133	Socket Impact Metric 1/2" Drive 33mm	1
KTI38134	Socket Impact Metric 1/2" Drive 34mm	1
KTI38135	Socket Impact Metric 1/2" Drive 35mm	1
KTI38136	Socket Impact Metric 1/2" Drive 36mm	1
KTI38210	Socket 1/2" Drive Impact Deep 10mm	1
KTI38211	Socket 1/2" Drive Impact Deep 11mm	1
KTI38212	Socket 1/2" Drive Impact Deep 12mm	1
KTI38213	Socket 1/2" Drive Impact Deep 13mm	1
KTI38214	Socket 1/2" Drive Impact Deep 14mm	1
KTI38215	Socket 1/2" Drive Impact Deep 15mm	1
KTI38216	Socket 1/2" Drive Impact Deep 16mm	1
KTI38217	Socket 1/2" Drive Impact Deep 17mm	1
KTI38218	Socket 1/2" Drive Impact Deep 18mm	1
KTI38219	Socket 1/2" Drive Impact Deep 19mm	1
KTI38220	Socket 1/2" Drive Impact Deep 20mm	1
KTI38221	Socket 1/2" Drive Impact Deep 21mm	1
KTI38222	Socket 1/2" Drive Impact Deep 22mm	1
KTI38223	Socket 1/2" Drive Impact Deep 23mm	1
KTI38224	Socket 1/2" Drive Impact Deep 24mm	1
KTI38225	Socket 1/2" Drive Impact Deep 25mm	1
KTI38226	Socket 1/2" Drive Impact Deep 26mm	1
KTI38227	Socket 1/2" Drive Impact Deep 27mm	1
KTI38228	Socket 1/2" Drive Impact Deep 28mm	1
KTI38229	Socket 1/2" Drive Impact Deep 29mm	1
KTI38230	Socket 1/2" Drive Impact Deep 30mm	1
KTI38232	Socket Impact Metric Deep 1/2" Drive 32mm	1
KTI38233	Socket Impact Metric Deep 1/2" Drive 33mm	1
KTI38234	Socket Impact Metric Deep 1/2" Drive 34mm	1
KTI38235	Socket Impact Metric Deep 1/2" Drive 35mm	1
KTI38236	Socket Impact Metric Deep 1/2" Drive 36mm	1
KTIH00K2	Hooks	146
KTIOL0839	Display Overlay	1
KTIOLF-04333	Overlay Fasteners (6 Pack)	1

KTI0840

Large Impact Sockets	Qty	
KTI34026	13/16" Square Budd Wheel Socket	1
KTI34027	1-1/2" - 13/16" Budd Wheel Socket 3/4" Drive	1
KTI34032	3/4" Female X 1" Male Impact Adapter	1
KTI34050	Universal Joint 3/4" Drive Impact	1
KTI34132	Socket 3/4" Drive Short Impact 1"	1
KTI34134	Socket 3/4" Drive Short Impact 1-1/16"	1
KTI34136	Socket 3/4" Drive Short Impact 1-1/8"	1
KTI34140	Socket 3/4" Drive Short Impact 1-1/4"	1
KTI34142	Socket 3/4" Drive Short Impact 1-5/16"	1
KTI34144	Socket 3/4" Drive Short Impact 1-3/8"	1
KTI34146	Socket 3/4" Drive Short Impact 1-7/16"	1
KTI34148	Socket 3/4" Drive Short Impact 1-1/2"	1
KTI34150	Socket 3/4" Drive Short Impact 1-9/16"	1
KTI34152	Socket 3/4" Drive Short Impact 1-5/8"	1
KTI34154	Socket 3/4" Drive Short Impact 1-11/16"	1
KTI34156	Socket 3/4" Drive Short Impact 1-3/4"	1
KTI34158	Socket 3/4" Drive Short Impact 1-13/16"	1
KTI34160	Socket 3/4" Drive Short Impact 1-15/16"	1
KTI34162	Socket 3/4" Drive Short Impact 1-7/8"	1
KTI34164	Socket 3/4" Drive Short Impact 2"	1
KTI34166	Socket 3/4" Drive Short Impact 2-1/16"	1
KTI34168	Socket 3/4" Drive Short Impact 2-1/8"	1
KTI34172	Socket 3/4" Drive Short Impact 2-1/4"	1
KTI34176	Socket 3/4" Drive Short Impact 2-3/8"	1
KTI34232	Socket 3/4" Drive Deep Impact 1"	1
KTI34234	Socket 3/4" Drive Deep Impact 1-1/16"	1
KTI34236	Socket 3/4" Drive Deep Impact 1-1/8"	1
KTI34240	Socket 3/4" Drive Deep Impact 1-1/4"	1
KTI34242	Socket 3/4" Drive Deep Impact 1-5/16"	1

KTI0840

Large Impact Sockets	Qty	
KTI34244	Socket 3/4" Drive Deep Impact 1-3/8"	1
KTI34246	Socket 3/4" Drive Deep Impact 1-7/16"	1
KTI34248	Socket 3/4" Drive Deep Impact 1-1/2"	1
KTI34250	Socket 3/4" Drive Deep Impact 1-9/16"	1
KTI34252	Socket 3/4" Drive Deep Impact 1-5/8"	1
KTI34254	Socket 3/4" Drive Deep Impact 1-11/16"	1
KTI34256	Socket 3/4" Drive Deep Impact 1-3/4"	1
KTI34258	Socket 3/4" Drive Deep Impact 1-13/16"	1
KTI34260	Socket 3/4" Drive Deep Impact 1-15/16"	1
KTI34262	Socket 3/4" Drive Deep Impact 1-7/8"	1
KTI34264	Socket 3/4" Drive Deep Impact 2"	1
KTI35024	1" Female X 3/4" Male Impact Adapter	1
KTI35026	Socket Impact 1" Drive 13/16" Square Budd Wheel	1
KTI35027	Socket Impact 1" Drive 1-1/2" - 13/16" Budd Wheel	1
KTI35233	Socket Impact Deep 1" Drive 33mm Hex Budd Wheel	1
KTIH00K8	Hooks	36
KTI088	Plexiglass Shelf	6
KTIOL0840	Display Overlay	1
KTIOLF-04333	Overlay Fasteners (6 Pack)	1

KTI0841

Locking Pliers and Clamps	Qty	
KTI58705	5" Curved-Jaw Locking Pliers	2
KTI58707	7" Curved-Jaw Locking Pliers	2
KTI58717	7" Straight-Jaw Locking Pliers	2
KTI58710	10" Curved-Jaw Locking Pliers	2
KTI58809	9" Locking Welding Clamp	1
KTI58811	11" Locking C-Clamp Pliers	1
KTI004	Counter Merchandiser	1
KTIH00K8	Hooks	7

KTI0842

Ratcheting Wrenches	Qty	
KTI45608	Wrench Metric Ratcheting Reversible 8mm	1
KTI45609	Wrench Metric Ratcheting Reversible 9mm	1
KTI45610	Wrench Metric Ratcheting Reversible 10mm	1
KTI45611	Wrench Metric Ratcheting Reversible 11mm	1
KTI45612	Wrench Metric Ratcheting Reversible 12mm	1
KTI45613	Wrench Metric Ratcheting Reversible 13mm	1
KTI45614	Wrench Metric Ratcheting Reversible 14mm	1
KTI45615	Wrench Metric Ratcheting Reversible 15mm	1
KTI45616	Wrench Metric Ratcheting Reversible 16mm	1
KTI45617	Wrench Metric Ratcheting Reversible 17mm	1
KTI45618	Wrench Metric Ratcheting Reversible 18mm	1
KTI45619	Wrench Metric Ratcheting Reversible 19mm	1
KTI45620	Wrench Metric Ratcheting Reversible 20mm	1
KTI45621	Wrench Metric Ratcheting Reversible 21mm	1
KTI45622	Wrench Metric Ratcheting Reversible 22mm	1
KTI45624	Wrench Metric Ratcheting Reversible 24mm	1
KTI45908	Wrench Fractional Ratcheting Reversible 1/4"	1
KTI45910	Wrench Fractional Ratcheting Reversible 5/16"	1
KTI45912	Wrench Fractional Ratcheting Reversible 3/8"	1
KTI45914	Wrench Fractional Ratcheting Reversible 7/16"	1
KTI45916	Wrench Fractional Ratcheting Reversible 1/2"	1
KTI45918	Wrench Fractional Ratcheting Reversible 9/16"	1
KTI45920	Wrench Fractional Ratcheting Reversible 5/8"	1
KTI45922	Wrench Fractional Ratcheting Reversible 11/16"	1
KTI45924	Wrench Fractional Ratcheting Reversible 3/4"	1
KTI45926	Wrench Fractional Ratcheting Reversible 13/16"	1
KTI45928	Wrench Fractional Ratcheting Reversible 7/8"	1
KTI45930	Wrench Fractional Ratcheting Reversible 15/16"	1
KTI45932	Wrench Fractional Ratcheting Reversible 1"	1
KTI089	Extension Bar	2
KTIH00K2	Hooks	15
KTIH00K11	Small Plastic Hook	14
KTIOL0842	Display Overlay	1
KTIOLF-04333	Overlay Fasteners (6 Pack)	1

KT10843

Electrical and Hardware Component Assortment Display Qty

KT100071150-piece Hitch Pin Assortment	1
KT100072300-piece E-Clip Assortment	1
KT100074110-piece Hydraulic Grease Fitting Assortment	1
KT100075555-piece Cotter Pin Assortment	1
KT100078144-piece Cotter Pin Assortment	1
KT100080120-piece Auto Fuse Assortment	1
KT100081120-piece Mini Fuse Assortment	2
KT100086270-piece O-Ring Assortment HNBR	1
KT100087360-piece Terminal Assortment	1
KT100089110-piece Washer Assortment Copper	1
KT100093120-piece Roll Pin Assortment	1
KT100094407-piece O-Ring Assortment Universal	1
KT100095419-piece Metric O-Ring Assortment	1
KT100096110-piece Grease Fitting Assortment Metric	1
KT100097157-piece Electrical Wire Solderless Terminal Kit	1
KT107740235-piece Heat Shrink Tube Kit	1

Displays and Merchandisers

KT1001 8-board Rotary Merchandiser

KT1's rotary merchandiser is the perfect way to display a maximum amount of product in a minimal amount of space. Rotary merchandiser will hold up to eight (8) displays!* The rotary display requires a minimal amount of space - only 36" x 36". Display is complete with four (4) durable casters for added mobility. A must-have for professional, effective merchandising. Boards (KT1098) sold separately.

*NOTE: Some displays are not recommended for use on the rotary merchandiser due to weight restrictions.



KT1098 Blank Display Board

Display boards can be used with any of the display overlay and merchandising kits listed or to create customized in-store merchandising programs. Blank display board measures 23.5" x 32". Color: black.



KT1088 Black Acrylic Plexi Shelf

- Contains 6, Black, Plexiglass shelves 24" x 3-9/16" X 3/16"



**CONTAINS DISPLAY BOARD,
BRACKETS & SHELVES ONLY
NO PRODUCT INCLUDED**

KT1004 Acrylic Counter Merchandiser

Acrylic counter display features a 15-11/16" x 15-13/16" display area to maximize product exposure. Compact design requires a minimal footprint (8" x 15-11/16"). A great way to generate 'impulse' buys. Utilizes 'dead' space behind point-of-sale terminals or computer monitors for additional merchandising area. Featuring two height adjustable legs, the display area has a tilt range from 75-degrees to 87-degrees.

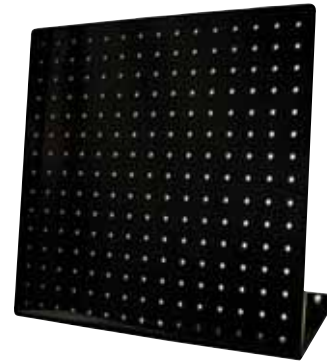

KT1005 Display Board, Fasteners and Slanted Wire Shelves

- Easy to set up
- Allows stores to expand their component offering without investing large sums in inventory or floor space
- Includes: display board, overlay, fasteners and slanted wire shelves.



**CONTAINS DISPLAY BOARD,
OVERLAY, FASTENERS &
SHELVES ONLY
NO PRODUCT INCLUDED**

KT1089 3" Display Extension Bar

Add more room to any display with the 3" extension bar. Larger product can be displayed behind the display bar with plenty of clearance for easy shopping and visual appeal. Place smaller product on the extension to maximize display space and sales!



KT1087 Slanted Wire Shelf

- Shelves measure 6" x 23.5" each



Index by Part Number

Part #	Page #	Part #	Page #	Part #	Page #	Part #	Page #
KTi00001	166; 168	KTi00831	153; 170	KTi03972	158; 169; 170	KTi04055	154; 168
KTi00002	166; 168	KTi00841	153; 170	KTi03973	158; 169; 170	KTi04056	154; 168
KTi00003	165; 168	KTi00851	153; 170	KTi03974	158; 169; 170	KTi04057	155; 169
KTi00004	165; 168	KTi00861	153; 170	KTi03975	158; 169; 170	KTi04058	155; 169
KTi00005	166; 168	KTi01611	150	KTi03976	158; 169; 170	KTi04059	155; 169
KTi00006	166; 168	KTi01641	151	KTi03977	158; 169; 170	KTi04060	155; 169
KTi00007	165; 168	KTi01651	150	KTi03978	158; 169; 170	KTi04061	155; 169
KTi00009	167; 168	KTi01661	151	KTi03979	158; 170	KTi04062	155; 169
KTi00020	164; 168	KTi01671	151	KTi03980	158; 170	KTi04063	155; 169
KTi00021	164; 168	KTi01912	151	KTi03984	158; 170	KTi04064	155; 169
KTi00022	171	KTi01920	151	KTi03985	158; 170	KTi04065	155; 169
KTi00023	167; 168	KTi01939	151	KTi04000	159; 168; 169	KTi04066	155; 169
KTi00024	167; 168	KTi02012	151	KTi04001	159; 168; 169	KTi04067	155; 169
KTi00026	164; 168	KTi02020	151	KTi04002	159; 168	KTi04068	155; 169
KTi00027	164; 168	KTi02039	151	KTi04003	159; 168	KTi04069	155; 168; 169
KTi00028	164; 169	KTi02112	151	KTi04004	159; 168	KTi04070	155; 168; 169
KTi00033	174	KTi02127	151	KTi04005	159; 168	KTi04071	155; 168; 169
KTi00034	174	KTi02130	151	KTi04006	159; 168	KTi04072	155; 169
KTi00035	165; 169	KTi02149	151	KTi04007	159; 169	KTi04073	155; 169
KTi00037	165; 169	KTi02212	151	KTi04008	158; 168; 169; 170	KTi04074	155; 169
KTi00038	165; 169	KTi02227	151	KTi04009	158; 168; 169; 170	KTi04075	155; 169
KTi00039	165; 169	KTi02230	151	KTi04010	158; 168; 169; 170	KTi04076	155; 169
KTi00040	167; 169	KTi02249	151	KTi04011	159; 168; 169	KTi04077	155; 169
KTi00042	167; 169	KTi02312	151	KTi04012	159; 168	KTi04078	155; 169
KTi00045	164; 169	KTi02327	151	KTi04013	159; 168; 169	KTi04079	155; 169
KTi00047	166; 169	KTi02330	151	KTi04014	159; 168; 169	KTi04080	155; 169
KTi00048	166; 169	KTi02349	151	KTi04015	159; 168; 169	KTi04081	155; 169
KTi00049	166; 170	KTi02411	150	KTi04016	159; 168; 169	KTi04082	155; 169
KTi00050	166; 170	KTi02421	150	KTi04017	159; 168	KTi04083	155; 169
KTi00058	167; 170	KTi02431	150	KTi04018	159; 168	KTi04084	155; 169
KTi00059	167; 170	KTi02441	150	KTi04019	159; 168	KTi04085	155; 169
KTi00067	164; 170	KTi02451	150	KTi04020	159; 168	KTi04086	154; 169
KTi00068	164; 170	KTi02461	150	KTi04021	159; 168	KTi04087	154; 169
KTi00069	164; 170	KTi02471	150	KTi04022	159; 168	KTi04088	154; 169
KTi00070	164; 170	KTi02481	150	KTi04023	158; 168; 169; 170	KTi04089	154; 169
KTi00071	171; 191	KTi02491	150	KTi04024	158; 168; 169; 170	KTi04090	154; 169
KTi00072	171; 191	KTi02511	150	KTi04025	158; 168; 169; 170	KTi04091	154; 169
KTi00074	171; 191	KTi02611	155; 169	KTi04026	158; 168; 169; 170	KTi04092	154; 169
KTi00075	171; 191	KTi02621	155; 169	KTi04027	158; 168	KTi04093	154; 169
KTi00077	171	KTi02631	155; 169	KTi04028	159; 168; 169; 170	KTi04094	154; 168; 169
KTi00078	171; 191	KTi02641	155; 169	KTi04029	159; 168; 169	KTi04095	154; 169
KTi00080	172; 191	KTi02651	155	KTi04030	159; 168; 169	KTi04096	154; 168; 169
KTi00081	172; 191	KTi02742	150	KTi04031	159; 168	KTi04097	154; 169
KTi00082	172	KTi02743	150	KTi04032	159; 168; 169; 170	KTi04098	154; 168; 169
KTi00084	172	KTi02744	150	KTi04033	160; 168	KTi04099	154; 169
KTi00085	172	KTi02745	150	KTi04034	160; 168	KTi04100	154; 169
KTi00086	172; 191	KTi02751	150	KTi04035	160; 168	KTi04101	154; 169
KTi00087	172; 191	KTi02761	150	KTi04036	160; 168	KTi04102	154; 169
KTi00089	173; 191	KTi02771	150	KTi04037	160; 168	KTi04103	154; 169
KTi00091	173	KTi02781	150	KTi04038	160; 168	KTi04104	154; 169
KTi00093	173; 191	KTi02791	150	KTi04039	160; 168	KTi04105	154; 169
KTi00094	173; 191	KTi03963	158	KTi04040	160; 168	KTi04106	155; 169
KTi00095	173; 191	KTi03964	158	KTi04041	160; 168	KTi04107	155; 169
KTi00096	174; 191	KTi03965	158	KTi04042	160; 168	KTi04108	155; 169
KTi00097	174; 191	KTi03966	158	KTi04049	154; 168	KTi04109	155; 169
KTi001	192	KTi03967	158	KTi04050	154; 168	KTi04120	157; 170
KTi004	190; 192	KTi03968	158	KTi04051	154; 168	KTi04121	157; 170
KTi005	181; 192	KTi03969	158	KTi04052	154; 168	KTi04123	157; 170
KTi00811	153; 170	KTi03970	158; 170	KTi04053	154; 168	KTi04124	157; 170
KTi00821	153; 170	KTi03971	158; 170	KTi04054	154; 168	KTi04125	157; 170

Index by Part Number

Part #	Page #	Part #	Page #	Part #	Page #	Part #	Page #
KTi04126	157; 170	KTi04242	156; 169	KTi05110	162; 170	KTi05377	161
KTi04134	157; 168	KTi04243	156; 169	KTi05111	162; 170	KTi05378	161
KTi04135	157; 168	KTi04245	156; 169	KTi05112	162; 170	KTi05379	161
KTi04136	157; 168	KTi04247	156; 169	KTi05113	162; 170	KTi05380	161
KTi04137	157; 168	KTi04251	156; 169	KTi05114	162; 170	KTi05381	161
KTi04138	157; 168	KTi04252	156; 169	KTi05115	162; 170	KTi05382	161
KTi04139	157; 168	KTi04253	156; 169	KTi05116	162; 170	KTi05383	161
KTi04140	157; 168	KTi04260	156; 169	KTi05117	162; 170	KTi05384	161
KTi04141	157; 170	KTi04261	156; 169	KTi05118	162; 170	KTi07740	174; 191
KTi04142	157; 170	KTi04262	156; 169	KTi05119	162; 170	KTi0805	176; 182
KTi04168	157; 170	KTi04263	156; 169	KTi05120	162; 170	KTi0806	176; 182
KTi04181	157; 170	KTi04264	156; 169	KTi05124	160	KTi0807	176; 182; 183
KTi04182	157; 170	KTi04265	156; 169	KTi05125	160	KTi0808	176; 183; 184
KTi04183	157; 170	KTi04266	156; 169	KTi05126	160	KTi0809	176; 184
KTi04184	157; 170	KTi04270	152; 170	KTi05127	160	KTi0810	177; 184
KTi04185	157; 170	KTi04271	152; 170	KTi05136	162	KTi0811	177; 184; 185
KTi04188	157; 170	KTi04272	152; 170	KTi05138	162	KTi0812	177; 185
KTi04189	157; 170	KTi04273	152; 170	KTi05141	162	KTi0813	178; 185
KTi04190	157; 170	KTi04274	152; 170	KTi05143	162	KTi0814	178; 185
KTi04193	157; 170	KTi04275	152; 170	KTi05145	162	KTi0815	178; 186
KTi04195	157; 170	KTi04276	152; 170	KTi05149	162	KTi0816	178; 186
KTi04196	157; 170	KTi04277	152; 170	KTi05151	162	KTi0817	178; 186
KTi04198	157; 170	KTi04278	152; 170	KTi05165	162	KTi0819	179; 186
KTi04199	152; 168; 169	KTi04279	152; 170	KTi05167	162	KTi0820	179; 186
KTi04200	152; 168; 169	KTi04280	152; 170	KTi05169	162	KTi0821	179; 186
KTi04201	152; 168; 169	KTi04281	152; 170	KTi05171	162	KTi0822	179; 186
KTi04202	152; 168; 169	KTi04282	152; 170	KTi05177	162	KTi0831	179; 186
KTi04203	152; 168; 169	KTi04283	152; 170	KTi05179	162	KTi0832	179; 187
KTi04204	152; 168; 169	KTi04284	152; 170	KTi05181	162	KTi0833	180; 187
KTi04205	152; 168; 169	KTi04285	152; 170	KTi05186	170	KTi0834	180; 187
KTi04206	152; 168; 169	KTi04286	152; 170	KTi05202	160	KTi0835	180; 188
KTi04207	152; 168; 169	KTi04308	156; 168	KTi05205	161	KTi0836	177; 188
KTi04208	152; 168; 169	KTi04309	156; 168	KTi05206	161	KTi0837	180; 189
KTi04209	152; 168	KTi04310	156; 168	KTi05207	161	KTi0838	180; 189
KTi04210	152; 168	KTi04311	156; 168	KTi05209	163	KTi0839	177; 189
KTi04211	152; 168	KTi04312	156; 168	KTi05211	163	KTi0840	177; 190
KTi04212	152; 168	KTi04313	156; 168	KTi05213	163	KTi0841	180; 190
KTi04213	152; 168	KTi04314	156; 168	KTi05215	163	KTi0842	178; 190
KTi04214	152; 168	KTi04315	156; 168	KTi05217	163	KTi0843	181; 191
KTi04215	152; 168	KTi04316	156; 168	KTi05219	163	KTi087	192
KTi04216	152; 168	KTi04317	156; 168	KTi05221	163	KTi088	190; 192
KTi04220	153; 168	KTi04318	156; 168	KTi05225	163	KTi089	182; 184; 185; 187; 188;
KTi04221	153; 168	KTi04319	156; 168	KTi05226	161		189; 190; 192
KTi04222	153; 168	KTi04320	156; 168	KTi05228	161	KTi098	192
KTi04223	153; 168	KTi04458	151	KTi05233	163	KTi10010	141
KTi04224	153; 168	KTi04471	151	KTi05235	163	KTi10210	141
KTi04226	153; 169	KTi04494	155; 169	KTi05237	163	KTi10215	141
KTi04227	153; 169	KTi04497	155; 169	KTi05243	163	KTi10330	7; 145
KTi04228	153; 169	KTi04626	167; 170	KTi05245	163	KTi11001	5
KTi04229	153; 169	KTi04627	171	KTi05253	163	KTi11002	5
KTi04230	153; 169	KTi05100	160; 170	KTi05255	163	KTi11003	5
KTi04231	153; 169	KTi05101	160; 170	KTi05257	161; 170	KTi11004	5
KTi04234	153; 168	KTi05102	160; 170	KTi05259	161; 170	KTi11005	5
KTi04235	153; 168	KTi05103	160; 170	KTi05370	161	KTi11006	5
KTi04236	153; 168	KTi05104	160; 170	KTi05371	161	KTi11007	5
KTi04237	153; 168	KTi05105	160; 170	KTi05372	163	KTi11008	5
KTi04238	153; 168	KTi05106	160; 170	KTi05373	163	KTi11009	5
KTi04239	153; 168	KTi05107	160; 170	KTi05374	163	KTi11010	5
KTi04240	156; 169	KTi05108	160; 170	KTi05375	161	KTi11011	5
KTi04241	156; 169	KTi05109	162; 170	KTi05376	161	KTi11012	5

Part #	Page #	Part #	Page #	Part #	Page #	Part #	Page #
KTI11018	5	KTI18008	16; 22	KTI19913	4	KTI21070	20
KTI11035	5	KTI18009	5	KTI19921	4	KTI21080	20
KTI11100	6	KTI18012	16; 22	KTI19924	4	KTI21091	19; 22; 182; 187
KTI11110	5	KTI18702	6; 35	KTI20045	10; 11; 24	KTI21092	19; 23; 182; 187
KTI11201	5	KTI18703	6; 35	KTI20210	10; 24	KTI21092RK	19
KTI11202	5	KTI18801	6; 35	KTI20212	10; 24	KTI21095	19; 182
KTI11203	5	KTI18802	6; 35	KTI20214	10; 24	KTI21100	9; 23
KTI11204	5	KTI18810	98	KTI20216	10; 24	KTI21106	9; 22; 23; 182; 187
KTI11205	5	KTI18820	98	KTI20218	10; 24	KTI21107	9; 22; 23; 182; 187
KTI11206	5	KTI18900	5	KTI20220	10; 24	KTI21108	9; 22; 23; 182; 187
KTI11207	5	KTI18901	5	KTI20222	10; 24	KTI21109	9; 22; 23; 182; 187
KTI11208	5	KTI18902	5	KTI20224	10; 24	KTI21110	9; 22; 23; 182; 187
KTI11209	5	KTI18903	5	KTI20226	10; 24	KTI21111	9; 22; 23; 182; 187
KTI11210	5	KTI18904	5	KTI20228	10; 24	KTI21112	9; 22; 23; 182; 187
KTI11211	5	KTI18905	5	KTI20310	11; 24	KTI21114	9; 22; 23; 182; 187
KTI11215	5	KTI18906	5	KTI20311	11; 24	KTI21116	9; 22; 23; 182; 187
KTI11220	5	KTI18907	5	KTI20312	11; 24	KTI21118	9; 23; 182; 187
KTI11221	5	KTI18910	5	KTI20313	11; 24	KTI21200	9; 23
KTI11223	5	KTI18915	5	KTI20314	11; 24	KTI21206	9; 182; 187
KTI11224	5	KTI18920	5; 6	KTI20315	11; 24	KTI21207	9; 23; 182; 187
KTI11225	5	KTI18925	5	KTI20316	11; 24	KTI21208	9; 22; 23; 182; 187
KTI11226	5	KTI19000	4; 184	KTI20317	11; 24	KTI21209	9; 22; 23; 182; 187
KTI11227	5	KTI19113	4; 184	KTI20318	11; 24	KTI21210	9; 22; 23; 182; 187
KTI11228	5	KTI19121	4; 184	KTI20319	11; 24	KTI21211	9; 22; 23; 182; 187
KTI11229	5	KTI19124	4; 184	KTI20412	10; 24	KTI21212	9; 22; 23; 182; 187
KTI11230	5	KTI19138	5	KTI20414	10; 24	KTI21214	9; 22; 23; 182; 187
KTI11231	5	KTI19201	184	KTI20416	10; 24	KTI21216	9; 22; 23; 182; 187
KTI11310	6; 184	KTI19203	4; 184	KTI20418	10; 24	KTI21218	9; 23; 182; 187
KTI11315	6; 184	KTI19204	4; 184	KTI20420	10; 24	KTI21500	16; 22; 184
KTI11320	6; 184	KTI19206	4; 184	KTI20422	10; 24	KTI21510	16; 18; 22
KTI14219	6	KTI19208	4; 184	KTI20424	10; 24	KTI21515	16; 18; 22
KTI14400	6; 188	KTI19209	7	KTI20426	10; 24	KTI21520	16; 18; 22
KTI14406	6; 188	KTI19212	7	KTI20428	10; 24	KTI21525	16; 18; 22
KTI14408	6; 188	KTI19218	7	KTI20707	11; 24	KTI21527	16; 18; 22
KTI14410	6; 188	KTI19224	7	KTI20708	11; 24	KTI21530	16; 18; 22
KTI14411	6; 188	KTI19240	7	KTI20709	11; 24	KTI21540	16; 18; 22
KTI14412	6; 188	KTI19700	4	KTI20710	11; 24	KTI21545	16; 18; 22
KTI14414	6; 188	KTI19701	4	KTI20711	11; 24	KTI21550	16; 18; 22
KTI14416	6; 188	KTI19703	4	KTI20712	11; 24	KTI21555	16; 18; 22
KTI14500	6; 188	KTI19704	4	KTI20713	11; 24	KTI21610	16; 18; 21; 184
KTI14505	6; 188	KTI19706	4	KTI20714	11; 24	KTI21615	16; 18; 21; 184
KTI14506	6; 188	KTI19708	4	KTI20715	11; 24	KTI21620	16; 18; 21; 184
KTI14507	6; 188	KTI19713	4	KTI20716	11; 24	KTI21625	16; 18; 21; 184
KTI14508	6; 188	KTI19721	4	KTI20717	11; 24	KTI21627	16; 18; 21; 184
KTI14509	6; 188	KTI19724	4	KTI20718	11; 24	KTI21630	16; 18; 21; 184
KTI14510	6; 188	KTI19800	4	KTI20719	11; 24	KTI21810	16; 17; 21; 184
KTI14511	6; 188	KTI19801	4	KTI21000	9; 22; 182	KTI21815	16; 17; 21; 184
KTI16000	4	KTI19803	4	KTI21002	19; 22; 23; 182; 187	KTI21820	16; 17; 21; 184
KTI16001	4; 184	KTI19804	4	KTI21004	19; 22; 182; 187	KTI21825	16; 17; 21; 184
KTI16002	4; 184	KTI19806	4	KTI21006	19; 23; 182; 187	KTI21827	16; 17; 21; 184
KTI16113	4; 184	KTI19808	4	KTI21010	19; 182	KTI21830	16; 17; 21; 184
KTI16121	4; 184	KTI19813	4	KTI21014	19; 182	KTI22000	10; 24; 182
KTI16124	4; 184	KTI19821	4	KTI21040	19	KTI22001	20
KTI16129	4; 184	KTI19824	4	KTI21043	19; 182	KTI22002	19; 24; 182
KTI16136	4; 184	KTI19900	4	KTI21044	9; 23; 182	KTI22003	19; 24; 26; 182; 187
KTI16201	4; 184	KTI19901	4	KTI21046	19; 182	KTI22005	19; 182
KTI16203	4; 184	KTI19903	4	KTI21048	19; 182	KTI22006	19; 24; 26; 182; 187
KTI16204	4; 184	KTI19904	4	KTI21050	18; 22; 182; 187	KTI22008	19; 182; 187
KTI16206	4; 184	KTI19906	4	KTI21055	18; 182; 187	KTI22010	19; 182
KTI16208	4; 184	KTI19908	4	KTI21060	20; 22; 182; 187	KTI22012	19; 182

Index by Part Number

Part #	Page #	Part #	Page #	Part #	Page #	Part #	Page #
KTI22018	19; 182	KTI22324	21	KTI22720	26	KTI23136	12; 27; 183; 187
KTI22023	26	KTI22328	21	KTI22722	26	KTI23140	12; 27; 183; 187
KTI22024	19; 182	KTI22401	10; 11; 25	KTI22724	26	KTI23142	12; 183
KTI22041	19	KTI22408	10; 25; 182	KTI22800	16; 21; 184	KTI23144	12; 183
KTI22043	19; 182	KTI22410	10; 25; 182	KTI22801	16; 21; 184	KTI23146	12; 183
KTI22046	19; 182	KTI22412	10; 25; 26; 182	KTI22802	18; 88	KTI23148	12; 183
KTI22047	10; 11; 26; 182	KTI22414	10; 25; 26; 182	KTI22840	16; 17; 18; 21; 88; 184	KTI23200	12; 27
KTI22048	19; 182	KTI22416	10; 25; 26; 182	KTI22845	16; 17; 18; 21; 88; 184	KTI23214	12; 183
KTI22050	18; 182; 187	KTI22418	10; 25; 26; 182	KTI22847	16; 17; 21; 184	KTI23216	12; 27; 183; 187
KTI22055	18; 182; 187	KTI22420	10; 25; 26; 182	KTI22850	16; 17; 18; 21; 88; 184	KTI23218	12; 27; 183; 187
KTI22060	18; 182; 187	KTI22422	10; 25; 26; 182	KTI22855	16; 17; 21; 184	KTI23220	12; 27; 183; 187
KTI22070	20	KTI22424	10; 25; 26; 182	KTI22860	16; 17; 21; 184	KTI23222	12; 27; 183; 187
KTI22071	20	KTI22426	10; 25; 26; 182	KTI22870	16; 22; 184	KTI23224	12; 27; 183; 187
KTI22075	18; 183; 187	KTI22428	10; 25; 26; 182	KTI22874	16; 17; 22; 184	KTI23226	12; 27; 183; 187
KTI22080	20	KTI22430	10; 25; 182	KTI22875	16; 17; 22; 184	KTI23228	12; 27; 183; 187
KTI22091	19; 24; 182; 187	KTI22432	10; 25; 182	KTI22876	16; 17; 22; 184	KTI23230	12; 27; 183; 187
KTI22092	19; 24; 26; 182; 187	KTI22500	18; 182; 187	KTI22877	16; 17; 22; 184	KTI23232	12; 183; 187
KTI22092RK	19	KTI22501	10; 11; 25	KTI22878	16; 17; 22; 184	KTI23234	12; 183; 187
KTI22093	19; 182	KTI22508	10; 25; 26; 182	KTI22880	16; 17; 22; 184	KTI23236	12; 183; 187
KTI22095	19; 182	KTI22510	10; 25; 26; 182	KTI22882	16; 17; 22; 184	KTI23240	12; 183; 187
KTI22100	10; 24	KTI22512	10; 25; 26; 182	KTI22884	16; 17; 22; 184	KTI23242	12; 183
KTI22108	10; 26	KTI22514	10; 25; 26; 182	KTI22886	16; 17; 22; 184	KTI23244	12; 183
KTI22110	10; 24; 26; 182; 187	KTI22516	10; 25; 26; 182	KTI22888	16; 17; 22; 184	KTI23246	12; 183
KTI22112	10; 24; 26; 182; 187	KTI22518	10; 25; 26; 182	KTI22902	16; 17; 88	KTI23248	28; 183
KTI22114	10; 24; 26; 182; 187	KTI22520	10; 25; 26; 182	KTI22904	16; 17; 184	KTI23308	18
KTI22116	10; 24; 26; 182; 187	KTI22521	10; 35; 182	KTI22905	16; 17; 184	KTI23348	12
KTI22118	10; 24; 26; 182; 187	KTI22522	10; 25; 26; 182	KTI22906	16; 17; 184	KTI23500	18; 183; 187
KTI22120	10; 24; 26; 182; 187	KTI22524	10; 25; 26	KTI22907	16; 17; 184	KPI23512	12
KTI22122	10; 24; 26; 182; 187	KTI22526	10; 25; 26; 183	KTI22908	16; 17; 88; 184	KTI23516	12
KTI22124	10; 24; 26; 182; 187	KTI22527	10; 35; 182	KTI22910	16; 17; 88; 184	KTI23800	12; 28
KTI22126	10; 24; 26; 182; 187	KTI22528	10; 25; 26; 183	KTI22912	16; 17; 88; 184	KTI23808	12; 28; 183
KTI22128	10; 24; 26; 182; 187	KTI22530	10; 25; 183	KTI22970	16; 17; 184	KTI23810	12; 28; 183
KTI22130	10; 182; 187	KTI22532	10; 25; 183	KTI23000	12; 27	KTI23812	12; 28; 183
KTI22132	10; 182; 187	KTI22547	10; 11; 26	KTI23003	19; 183; 187	KTI23814	12; 28; 183
KTI22133	35; 182	KTI22600	16; 21	KTI23005	19; 27; 183; 187	KPI23900	12; 28
KTI22201	24	KTI22601	16; 21; 184	KTI23010	19; 183; 187	KTI23906	12; 28; 183
KTI22202	10	KTI22640	16; 18; 21; 184	KTI23015	19; 183	KTI23908	12; 28; 183
KTI22208	10	KTI22645	16; 18; 21; 184	KTI23020	19; 183	KTI23910	12; 28; 183
KTI22210	10	KTI22647	16; 18; 21; 184	KTI23070	20	KTI23912	12; 28; 183
KTI22212	10; 24; 26; 182; 187	KTI22650	16; 18; 21; 184	KTI23080	20; 27; 183	KTI24004	19; 28
KTI22214	10; 24; 26; 182; 187	KTI22655	16; 18; 21; 184	KTI23081	20; 183	KTI24008	19; 28
KTI22216	10; 24; 26; 182; 187	KTI22660	16; 18; 21; 184	KTI23082	20	KPI24016	19
KTI22218	10; 24; 26; 182; 187	KTI22670	16; 18; 184	KTI23083	20	KTI24050	18; 183
KTI22219	10; 24; 35; 182	KTI22671	16; 18; 22; 184	KTI23091	19; 27; 183; 187	KTI24070	20; 28
KTI22220	10; 24; 26; 182; 187	KTI22675	16; 18; 22; 184	KTI23092	19; 183; 187	KTI24080	20
KTI22221	10; 35; 182; 188	KTI22676	16; 18; 22; 184	KTI23092RK	19	KTI24085	34
KTI22222	10; 24; 26; 182; 187	KTI22677	16; 18; 22; 184	KTI23095	19	KTI24090	19; 28
KTI22224	10; 24; 26; 182; 187	KTI22678	16; 18; 22; 184	KTI23110	12; 27	KTI24090RK	19
KTI22226	10; 24; 26; 182; 187	KTI22680	16; 18; 22; 184	KTI23112	12; 183	KTI24092	19
KTI22227	10; 35; 182; 188	KTI22682	16; 18; 22; 184	KTI23114	12; 27; 183	KTI24105	12; 28
KTI22228	10; 24; 26; 182; 187	KTI22684	16; 18; 22; 184	KTI23116	12; 27; 183; 187	KTI24121	12; 28
KTI22230	10; 182; 187	KTI22686	16; 18; 22; 184	KTI23118	12; 27; 183; 187	KTI24124	12; 28
KTI22232	10; 182; 187	KTI22688	16; 18; 22; 184	KTI23120	12; 27; 183; 187	KTI24128	12; 28
KTI22300	21; 37	KTI22689	16; 18; 22; 184	KTI23122	12; 27; 183; 187	KTI24130	12; 28
KTI22312	21	KTI22700	25	KTI23124	12; 27; 183; 187	KTI24132	12; 28
KTI22314	21	KTI22710	26	KTI23126	12; 27; 183; 187	KTI24134	12; 28
KTI22316	21	KTI22712	26	KTI23128	12; 27; 183; 187	KTI24136	12; 28
KTI22318	21	KTI22714	26	KTI23130	12; 27; 183; 187	KTI24138	12; 28
KTI22320	21	KTI22716	26	KTI23132	12; 27; 183; 187	KTI24140	12; 28
KTI22322	21	KTI22718	26	KTI23134	12; 27; 183; 187	KTI24142	12; 28

Part #	Page #	Part #	Page #	Part #	Page #	Part #	Page #
KTI24144	12; 28	KTI27122	11; 183	KTI27511	11; 25; 26; 183	KTI28226	12; 184
KTI24146	12; 28	KTI27123	11; 183	KTI27512	11; 25; 26; 183	KTI28227	12; 184
KTI24148	12; 28	KTI27124	11; 183	KTI27513	11; 25; 26; 183	KTI28228	12; 184
KTI24152	12; 28	KTI27125	11; 183	KTI27514	11; 25; 26; 183	KTI28229	12; 28
KTI24156	12; 28	KTI27126	11; 183	KTI27515	11; 25; 26; 183	KTI28230	12; 28
KTI24160	12; 28	KTI27201	11; 25	KTI27516	11; 25; 26; 183	KTI28232	12; 28
KTI24164	12; 28	KTI27206	11	KTI27517	11; 25; 26; 183	KTI28234	12; 28
KTI24166	12; 28	KTI27207	11	KTI27518	11; 25; 26; 183	KTI28235	12; 28
KTI24168	12; 28	KTI27208	11	KTI27519	11; 25; 26; 183	KTI28236	12; 28
KTI24170	12; 28	KTI27209	11	KTI27520	11; 25; 183	KTI32003	30; 35
KTI24172	12; 28	KTI27210	11; 24; 25; 26; 183; 188	KTI27521	11; 25; 183	KTI32012	34; 189
KTI24173	12	KTI27211	11; 24; 25; 26; 183; 188	KTI27902	16; 17; 88	KTI32013	30
KTI24176	12; 28	KTI27212	11; 24; 25; 26; 183; 188	KTI27903	16; 17; 184	KTI32016	34; 189
KTI24500	18	KTI27213	11; 24; 25; 26; 183; 188	KTI27904	16; 17; 184	KTI32100	13; 29
KTI26000	9; 22; 182	KTI27214	11; 24; 25; 26; 183; 188	KTI27905	16; 17; 184; 185	KTI32110	13; 30; 189
KTI26100	9; 23	KTI27215	11; 25; 26; 183; 188	KTI27906	16; 17; 184; 185	KTI32112	13; 29; 30; 189
KTI26104	9; 22; 23; 182	KTI27216	11; 24; 25; 26; 183; 188	KTI27907	16; 17; 88; 184; 185	KTI32114	13; 29; 30; 189
KTI26105	9; 22; 23; 182; 188	KTI27217	11; 24; 25; 26; 183; 188	KTI27908	16; 17; 88; 184; 185	KTI32116	13; 29; 30; 189
KTI26106	9; 22; 23; 182; 188	KTI27218	11; 24; 25; 26; 183; 188	KTI27910	16; 17; 88; 184; 185	KTI32118	13; 29; 30; 189
KTI26107	9; 22; 23; 182; 188	KTI27219	11; 24; 26; 183; 188	KTI27955	16; 184; 185	KTI32120	13; 29; 30; 189
KTI26108	9; 22; 23; 182; 188	KTI27220	11; 183	KTI27970	16; 17; 184; 185	KTI32122	13; 29; 30; 189
KTI26109	9; 22; 23; 182; 188	KTI27221	11; 183	KTI28000	12; 27	KTI32124	13; 29; 30; 189
KTI26110	9; 22; 23; 182; 188	KTI27222	11; 183	KTI28100	12; 27	KTI32126	13; 29; 189
KTI26111	9; 22; 23; 182; 188	KTI27223	11; 183	KTI28110	12; 183; 188	KTI32128	13; 29; 189
KTI26112	9; 23; 188	KTI27224	11; 183	KTI28111	12; 183; 188	KTI32200	13; 29
KTI26113	9; 23; 188	KTI27225	11; 183	KTI28112	12; 183; 188	KTI32210	13; 30; 189
KTI26114	9; 23; 182; 188	KTI27226	11; 183	KTI28113	12; 183; 188	KTI32212	13; 29; 30; 189
KTI26115	9; 23; 182; 188	KTI27300	21; 37	KTI28114	12; 183; 188	KTI32214	13; 29; 30; 189
KTI26155	9; 22; 23; 182; 188	KTI27310	21	KTI28115	12; 27; 183; 188	KTI32216	13; 29; 30; 189
KTI26200	9; 23	KTI27311	21	KTI28116	12; 27; 183; 188	KTI32218	13; 29; 30; 189
KTI26206	9; 22; 23; 182; 188	KTI27312	21	KTI28117	12; 27; 183; 188	KTI32220	13; 29; 30; 189
KTI26207	9; 22; 23; 182; 188	KTI27313	21	KTI28118	12; 27; 183; 188	KTI32222	13; 29; 30; 189
KTI26208	9; 22; 23; 182; 188	KTI27314	21	KTI28119	12; 27; 183; 188	KTI32224	13; 29; 30; 189
KTI26209	9; 22; 23; 182; 188	KTI27315	21	KTI28120	12; 27; 183; 188	KTI32226	13; 29; 189
KTI26210	9; 22; 23; 182; 188	KTI27316	21	KTI28121	12; 27; 183; 188	KTI32228	13; 29; 189
KTI26211	9; 22; 23; 182; 188	KTI27317	21	KTI28122	12; 27; 183	KTI32229	35
KTI26212	9; 23; 182; 188	KTI27318	21	KTI28123	12; 27; 183	KTI32400	13; 29
KTI26213	9; 23; 182; 188	KTI27319	21	KTI28124	12; 27; 184	KTI32414	13; 29
KTI26214	9; 23; 182; 188	KTI27401	25	KTI28125	12; 27; 184	KTI32416	13; 29
KTI26215	9; 23; 182; 188	KTI27407	11; 25; 183	KTI28126	12; 27; 184	KTI32418	13; 29
KTI26255	9; 22; 182; 188	KTI27408	11; 25; 183	KTI28127	12; 27; 184	KTI32420	13; 29
KTI27000	11; 24; 182	KTI27409	11; 25; 183	KTI28128	12; 27; 184	KTI32422	13; 29
KTI27100	11	KTI27410	11; 25; 26; 183	KTI28200	12; 27	KTI32424	13; 29
KTI27101	25	KTI27411	11; 25; 26; 183	KTI28206	12; 28	KTI32500	13; 29
KTI27106	11; 26	KTI27412	11; 25; 26; 183	KTI28210	12; 184; 188	KTI32514	13; 29
KTI27107	11; 25; 26	KTI27413	11; 25; 26; 183	KTI28211	12; 184; 188	KTI32516	13; 29
KTI27108	11; 24; 25; 26; 183; 188	KTI27414	11; 25; 26; 183	KTI28212	12; 184; 188	KTI32518	13; 29
KTI27109	11; 24; 25; 26; 183; 188	KTI27415	11; 25; 26; 183	KTI28213	12; 184; 188	KTI32520	13; 29
KTI27110	11; 24; 25; 26; 183; 188	KTI27416	11; 25; 26; 183	KTI28214	12; 184; 188	KTI32522	13; 29
KTI27111	11; 24; 25; 26; 183; 188	KTI27417	11; 25; 26; 183	KTI28215	12; 27; 184; 188	KTI32524	13; 29
KTI27112	11; 24; 25; 26; 183; 188	KTI27418	11; 25; 26; 183	KTI28216	12; 27; 184; 188	KTI33003	35; 189
KTI27113	11; 24; 25; 26; 183; 188	KTI27419	11; 25; 26; 183	KTI28217	12; 27; 184; 188	KTI33006	35; 189
KTI27114	11; 24; 25; 26; 183; 188	KTI27420	11; 25; 183	KTI28218	12; 27; 184; 188	KTI33012	34; 189
KTI27115	11; 24; 25; 26; 183; 188	KTI27421	11; 25; 183	KTI28219	12; 27; 184; 188	KTI33016	34; 189
KTI27116	11; 24; 25; 26; 183; 188	KTI27501	25	KTI28220	12; 27; 184; 188	KTI33024	34; 189
KTI27117	11; 24; 25; 26; 183; 188	KTI27506	11; 26	KTI28221	12; 27; 184; 188	KTI33041	34; 189
KTI27118	11; 24; 25; 26; 183; 188	KTI27507	11; 25; 26; 183	KTI28222	12; 27; 184	KTI33050	14; 189
KTI27119	11; 24; 25; 26; 183; 188	KTI27508	11; 25; 26; 183	KTI28223	12; 27; 184	KTI33100	14; 31
KTI27120	11; 24; 183	KTI27509	11; 25; 26; 183	KTI28224	12; 27; 184	KTI33101	14; 32
KTI27121	11; 24; 183	KTI27510	11; 25; 26; 183	KTI28225	12; 184	KTI33104	14; 31

Index by Part Number

Part #	Page #	Part #	Page #	Part #	Page #	Part #	Page #
KTI33112	14; 32; 189	KTI33520	14; 32	KTI35028	15; 34	KTI37410	13; 30
KTI33114	14; 32; 189	KTI33522	14; 32	KTI35100	15; 34	KTI37411	13; 30
KTI33116	14; 31; 32; 189	KTI33524	14; 32	KTI35124	15; 34	KTI37412	13; 30
KTI33118	14; 31; 32; 189	KTI33526	14; 32	KTI35126	15; 34	KTI37413	13; 30
KTI33120	14; 31; 32; 189	KTI33528	14; 32	KTI35128	15; 34	KTI37414	13; 30
KTI33122	14; 31; 32; 189	KTI34016	34; 189	KTI35130	15; 34	KTI37415	13; 30
KTI33124	14; 31; 32; 189	KTI34026	15; 34; 190	KTI35132	15; 34	KTI37416	13; 30
KTI33126	14; 31; 32; 189	KTI34027	15; 34; 190	KTI35134	15; 34	KTI37417	13; 30
KTI33128	14; 31; 32; 189	KTI34032	34; 190	KTI35136	15; 34	KTI37418	13; 30
KTI33130	14; 31; 32; 189	KTI34050	34; 190	KTI35138	15	KTI37419	13; 30
KTI33132	14; 31; 32; 189	KTI34100	15; 33	KTI35140	15; 34	KTI37500	30
KTI33134	14; 31; 32; 189	KTI34101	15; 33	KTI35142	15; 34	KTI37510	13; 30
KTI33136	14; 31; 32; 189	KTI34132	15; 33; 190	KTI35146	15; 34	KTI37511	13; 30
KTI33138	14; 32; 189	KTI34134	15; 33; 190	KTI35148	15; 34	KTI37512	13; 30
KTI33140	14; 31; 32; 189	KTI34136	15; 33; 190	KTI35152	15; 34	KTI37513	13; 30
KTI33142	14; 31; 32; 189	KTI34140	15; 33; 190	KTI35154	15; 34	KTI37514	13; 30
KTI33144	14; 31; 32; 189	KTI34142	15; 33; 190	KTI35158	15; 34	KTI37515	13; 30
KTI33146	14; 31; 32; 189	KTI34144	15; 33; 190	KTI35160	15; 34	KTI38050	14; 189
KTI33148	14; 31; 32; 189	KTI34146	15; 33; 190	KTI35164	15; 34	KTI38100	14; 31
KTI33200	14; 31	KTI34148	15; 33; 190	KTI35166	15	KTI38101	14; 32
KTI33202	14; 32	KTI34150	15; 33; 190	KTI35172	15	KTI38110	14; 31; 32; 189
KTI33204	14; 31	KTI34152	15; 33; 190	KTI35178	15	KTI38111	14; 31; 32; 189
KTI33212	14; 32; 189	KTI34154	15; 33; 190	KTI35184	15	KTI38112	14; 31; 32; 189
KTI33214	14; 32; 189	KTI34156	15; 33; 190	KTI35196	15	KTI38113	14; 31; 32; 189
KTI33216	14; 31; 32; 189	KTI34158	15; 33; 190	KTI35233	15; 34; 190	KTI38114	14; 31; 32; 189
KTI33218	14; 31; 32; 189	KTI34160	15; 33; 190	KTI35234	15	KTI38115	14; 31; 32; 189
KTI33220	14; 31; 32; 189	KTI34162	15; 33; 190	KTI35235	15; 34	KTI38116	14; 31; 32; 189
KTI33222	14; 31; 32; 189	KTI34164	15; 33; 190	KTI35236	15	KTI38117	14; 31; 32; 189
KTI33224	14; 31; 32; 189	KTI34166	15; 33; 190	KTI35238	15; 34	KTI38118	14; 31; 32; 189
KTI33226	14; 31; 32; 189	KTI34168	15; 33; 190	KTI35240	15	KTI38119	14; 31; 32; 189
KTI33228	14; 31; 32; 189	KTI34172	15; 33; 190	KTI35241	15; 34	KTI38120	14; 31; 32; 189
KTI33230	14; 31; 32; 189	KTI34176	15; 33; 190	KTI35242	15	KTI38121	14; 31; 32; 189
KTI33232	14; 31; 32; 189	KTI34200	15; 33	KTI37042	13; 30	KTI38122	14; 32; 189
KTI33234	14; 31; 32; 189	KTI34201	15; 33	KTI37100	13; 29	KTI38123	14; 32; 189
KTI33236	14; 31; 32; 189	KTI34232	15; 33; 190	KTI37108	13; 30; 189	KTI38124	14; 32; 190
KTI33238	14; 32; 189	KTI34234	15; 33; 190	KTI37109	13; 30; 189	KTI38125	14; 32; 190
KTI33240	14; 31; 32; 189	KTI34236	15; 33; 190	KTI37110	13; 29; 30; 189	KTI38126	14; 32; 190
KTI33242	14; 31; 32; 189	KTI34240	15; 33; 190	KTI37111	13; 29; 30; 189	KTI38127	14; 32; 190
KTI33244	14; 31; 32; 189	KTI34242	15; 33; 190	KTI37112	13; 29; 30; 189	KTI38128	14; 32; 190
KTI33246	14; 31; 32; 189	KTI34244	15; 33; 190	KTI37113	13; 29; 30; 189	KTI38129	14; 32; 190
KTI33248	14; 31; 32; 189	KTI34246	15; 33; 190	KTI37114	13; 29; 30; 189	KTI38130	14; 32; 190
KTI33300	90	KTI34248	15; 33; 190	KTI37115	13; 29; 30; 189	KTI38132	14; 32; 190
KTI33317	90	KTI34250	15; 33; 190	KTI37116	13; 29; 30; 189	KTI38133	14; 32; 190
KTI33319	90	KTI34252	15; 33; 190	KTI37117	13; 29; 30; 189	KTI38134	14; 32; 190
KTI33321	90	KTI34254	15; 33; 190	KTI37118	13; 29; 30; 189	KTI38135	14; 32; 190
KTI33326	90	KTI34256	15; 33; 190	KTI37119	13; 29; 30; 189	KTI38136	14; 32; 190
KTI33328	90	KTI34258	15; 33; 190	KTI37200	13; 29	KTI38200	14; 31
KTI33332	90	KTI34260	15; 33; 190	KTI37208	13; 30; 189	KTI38201	14; 33
KTI33334	90	KTI34262	15; 33; 190	KTI37209	13; 30; 189	KTI38202	14; 32
KTI33350	90	KTI34264	15; 33; 190	KTI37210	13; 29; 30; 189	KTI38210	14; 31; 32; 190
KTI33351	90	KTI35001	34	KTI37211	13; 29; 30; 189	KTI38211	14; 31; 32; 190
KTI33352	90	KTI35002	34	KTI37212	13; 29; 30; 189	KTI38212	14; 31; 32; 190
KTI33353	90	KTI35003	34	KTI37213	13; 29; 30; 189	KTI38213	14; 31; 32; 190
KTI33354	90	KTI35004	34	KTI37214	13; 29; 30; 189	KTI38214	14; 31; 32; 190
KTI33355	90	KTI35005	15; 34	KTI37215	13; 29; 30; 189	KTI38215	14; 31; 32; 190
KTI33356	90	KTI35007	34; 35	KTI37216	13; 29; 30; 189	KTI38216	14; 31; 32; 190
KTI33357	90	KTI35013	34; 35	KTI37217	13; 29; 30; 189	KTI38217	14; 31; 32; 190
KTI33500	14; 32	KTI35024	34; 190	KTI37218	13; 29; 30; 189	KTI38218	14; 31; 32; 190
KTI33516	14; 32	KTI35026	15; 34; 190	KTI37219	13; 29; 30; 189	KTI38219	14; 31; 32; 190
KTI33518	14; 32	KTI35027	15; 34; 190	KTI37400	13; 30	KTI38220	14; 31; 32; 190

Part #	Page #	Part #	Page #	Part #	Page #	Part #	Page #
KTI38221	14; 31; 32; 190	KTI41134	38; 185; 188	KTI41609	40; 185; 188	KTI43116	39
KTI38222	14; 32; 33; 190	KTI41136	38; 185; 188	KTI41610	40; 185; 188	KTI43120	39
KTI38223	14; 32; 33; 190	KTI41140	38; 185	KTI41611	40; 185; 188	KTI43124	39
KTI38224	14; 32; 33; 190	KTI41142	38; 185	KTI41612	40; 185; 188	KTI43500	47
KTI38225	14; 32; 33; 190	KTI41144	38; 185	KTI41613	40; 185; 188	KTI43510	41
KTI38226	14; 32; 33; 190	KTI41146	38; 185	KTI41614	40; 185; 188	KTI43513	41
KTI38227	14; 32; 33; 190	KTI41148	38; 185	KTI41615	40; 185; 188	KTI43515	41
KTI38228	14; 32; 33; 190	KTI41152	38; 185	KTI41616	40; 185; 188	KTI43518	41
KTI38229	14; 32; 33; 190	KTI41156	38; 185	KTI41617	40; 185; 188	KTI43519	41
KTI38230	14; 32; 33; 190	KTI41158	38	KTI41618	40; 185; 188	KTI44003	44
KTI38232	14; 32; 190	KTI41160	38; 185	KTI41619	40; 185; 188	KTI44412	42; 188
KTI38233	14; 32; 190	KTI41164	38; 185	KTI41700	37; 46	KTI44416	42; 188
KTI38234	14; 32; 190	KTI41168	38; 185	KTI41708	40	KTI44420	42; 188
KTI38235	14; 32; 190	KTI41172	38; 185	KTI41710	40; 185	KTI44500	46
KTI38236	14; 32; 190	KTI41176	38; 185	KTI41712	40; 185	KTI44910	42
KTI38500	14; 32	KTI41180	38; 185	KTI41713	40; 185	KTI44913	42
KTI38513	14; 32	KTI41200	37; 44	KTI41714	40; 185	KTI44917	42
KTI38514	14; 32	KTI41212	38; 185	KTI41715	40; 185	KTI45208	39
KTI38515	14; 32	KTI41214	38; 185	KTI41717	40; 185	KTI45212	39
KTI38517	14; 32	KTI41216	38; 185	KTI41718	40; 185	KTI45216	39
KTI38518	14; 32	KTI41218	38; 185	KTI41800	37; 46	KTI45220	39
KTI38519	14; 32	KTI41220	38; 185	KTI41801	37; 46	KTI45318	39
KTI39001	33	KTI41222	38; 185	KTI41802	37; 46	KTI45400	37; 45
KTI39003	33	KTI41224	38; 185	KTI41807	40; 185	KTI45410	39
KTI39100	15; 33	KTI41300	37; 44	KTI41808	40; 185	KTI45412	39
KTI39117	15; 33	KTI41304	37; 44	KTI41809	40; 185	KTI45414	39
KTI39119	15; 33	KTI41305	44	KTI41810	40; 185	KTI45416	39
KTI39120	15; 33	KTI41308	38	KTI41811	40; 185	KTI45418	39
KTI39122	15; 33	KTI41311	38	KTI41812	40; 185	KTI45420	39
KTI39124	15; 33	KTI41312	38; 185	KTI41813	40; 185	KTI45424	39
KTI39127	15; 33	KTI41314	38; 185	KTI41814	40; 185	KTI45500	37; 47
KTI39130	15; 33	KTI41316	38; 185	KTI41815	40; 185	KTI45508	41
KTI39131	15; 33	KTI41318	38; 185	KTI41816	40; 185	KTI45510	41
KTI39132	15; 33	KTI41320	38; 185	KTI41817	40; 185	KTI45512	41
KTI39134	15; 33	KTI41322	38; 185	KTI41818	40; 185	KTI45513	41
KTI39135	15; 33	KTI41324	38; 185	KTI41819	40; 185	KTI45514	41
KTI39136	15; 33	KTI41326	38; 185	KTI41820	40; 185	KTI45515	41
KTI39138	15; 33	KTI41328	38; 185	KTI41821	40; 185	KTI45518	41
KTI39140	15; 33	KTI41330	38; 185	KTI41822	40; 185	KTI45600	37; 47
KTI39146	15; 33	KTI41332	38; 185	KTI41823	40; 185	KTI45601	47
KTI39233	15; 34	KTI41334	38; 185	KTI41824	40; 185	KTI45602	47
KTI41004	37; 43	KTI41336	38; 185	KTI41825	40; 185	KTI45608	41; 190
KTI41006	37; 43	KTI41338	38	KTI41826	40; 185	KTI45609	41; 190
KTI41011	37; 43	KTI41340	38; 185	KTI41827	40; 185	KTI45610	41; 190
KTI41013	37; 43	KTI41342	38	KTI41828	40; 185	KTI45611	41; 190
KTI41014	37; 43	KTI41344	38	KTI41829	40; 185	KTI45612	41; 190
KTI41016	37; 43	KTI41346	38	KTI41830	40; 185	KTI45613	41; 190
KTI41108	38; 188	KTI41348	38	KTI41831	40; 185	KTI45614	41; 190
KTI41110	38; 185; 188	KTI41350	38	KTI41832	40; 185	KTI45615	41; 190
KTI41112	38; 185; 188	KTI41352	38	KTI41833	40; 185	KTI45616	41; 190
KTI41114	38; 185; 188	KTI41412	38; 185	KTI41834	40; 185	KTI45617	41; 190
KTI41116	38; 185; 188	KTI41414	38; 185	KTI41835	40; 185	KTI45618	41; 190
KTI41118	38; 185; 188	KTI41416	38; 185	KTI41836	40; 185	KTI45619	41; 190
KTI41120	38; 185; 188	KTI41418	38; 185	KTI42316	42	KTI45620	41; 190
KTI41122	38; 185; 188	KTI41420	38; 185	KTI42318	42	KTI45621	41; 190
KTI41124	38; 185; 188	KTI41422	38; 185	KTI42320	42	KTI45622	41; 190
KTI41126	38; 185; 188	KTI41424	38; 185	KTI42348	42	KTI45624	41; 190
KTI41128	38; 185; 188	KTI41513	37; 46	KTI42818	42	KTI45900	37; 45
KTI41130	38; 185; 188	KTI41607	40	KTI43100	45	KTI45901	45
KTI41132	38; 185; 188	KTI41608	40; 185; 188	KTI43112	39	KTI45902	45

Index by Part Number

Part #	Page #	Part #	Page #	Part #	Page #	Part #	Page #
KTI45908	39; 190	KTI54012	52; 186	KTI63131	128	KTI70025	60; 186
KTI45910	39; 190	KTI54050	52	KTI63133	126	KTI70026	60; 186
KTI45912	39; 190	KTI55001	54	KTI63134	128	KTI70027	60
KTI45914	39; 190	KTI55012	54	KTI63136	128	KTI70028	60
KTI45916	39; 190	KTI55034	54	KTI63155	127	KTI70029	60; 186
KTI45918	39; 190	KTI55112	54; 186	KTI63186	127	KTI70031	61
KTI45920	39; 190	KTI55120	54; 186	KTI63194	127	KTI70032	61
KTI45922	39; 190	KTI55121	54; 186	KTI63198	127	KTI70033	61
KTI45924	39; 190	KTI55122	54; 186	KTI63201	121	KTI70034	61
KTI45926	39; 190	KTI55123	54; 186	KTI63207	121	KTI70035	61
KTI45928	39; 190	KTI55130	54; 186	KTI63212TW	121	KTI70036	61
KTI45930	39; 190	KTI55131	54; 186	KTI63213	122	KTI70040	66; 188
KTI45932	39; 190	KTI55132	54; 186	KTI63214	122	KTI70045	66
KTI48004	48; 186	KTI55133	54; 186	KTI63221	122	KTI70050	66
KTI48004T	48	KTI55140	54; 186	KTI63224	122	KTI70052	85
KTI48006	48; 186	KTI55141	54; 186	KTI63228	122	KTI70054	85
KTI48006GT	48	KTI55142	54; 186	KTI63230	122	KTI70056	85
KTI48008	48; 186	KTI55143	54; 186	KTI63250	122	KTI70057	85
KTI48010	48; 186	KTI55912	54	KTI63414	125	KTI70060	79
KTI48012	48; 186	KTI55934	54	KTI63421	125	KTI70060-1	79
KTI48012BTW	48	KTI56201	149	KTI63427	125	KTI70061	79
KTI48015	48	KTI56202	149	KTI63500	129	KTI70062	79
KTI48018	48	KTI56203	149	KTI63502	129	KTI70063	79
KTI49000	49	KTI56204	149	KTI63505	129	KTI70064	79
KTI49008	49; 186	KTI56207	149	KTI63515	129	KTI70065	79
KTI49010	49; 186	KTI56208	149	KTI63517	129	KTI70066	79
KTI49012	49; 186	KTI56209	149	KTI63611	131	KTI70067	79
KTI49014	49; 186	KTI57124	63	KTI63619	131	KTI70068	79
KTI49018	49; 186	KTI57130	63	KTI63703	130	KTI70069	79
KTI49024	49; 186	KTI57136	63	KTI63709	130	KTI70070	65; 188
KTI49036	49	KTI57224	63	KTI63716	130	KTI70071	65
KTI49112	49	KTI57236	63	KTI63800	131	KTI70072	65
KTI49114	49	KTI57414	63	KTI63820	131	KTI70073	65
KTI49118	49	KTI57424	63	KTI64001	121	KTI70074	65
KTI49124	49	KTI57436	63	KTI64005	121	KTI70075	65; 188
KTI49136	49	KTI57514	63	KTI64006	121	KTI70076	65
KTI49309	48	KTI58705	53; 190	KTI64008	121	KTI70077	65
KTI49315	48	KTI58707	53; 190	KTI64105	121	KTI70078	65
KTI49400	49	KTI58710	53; 190	KTI64106	121	KTI70079	65
KTI49405	49	KTI58717	53; 190	KTI64108	121	KTI70080	79
KTI50201	148	KTI58809	53; 190	KTI70002	56; 186	KTI70081	78
KTI51006	52; 186	KTI58811	53; 190	KTI70004	60	KTI70082	78
KTI51006T	52	KTI60060	121	KTI70005	60	KTI70085	78
KTI51007	52; 186	KTI61002	123	KTI70006	60	KTI70099	69
KTI51008	52; 186	KTI61076	123	KTI70007	60	KTI70163	88
KTI51103	52	KTI61077	123	KTI70008	60	KTI70182	85
KTI51111	52; 186	KTI61202	123	KTI70009	60	KTI70183	85
KTI51206	52	KTI61205	123	KTI70010	65	KTI70184	85
KTI51211	52; 186	KTI61211	123	KTI70010	65	KTI70186	85
KTI51311	52; 186	KTI61222	123	KTI70013	144	KTI70186	85
KTI52006	52; 186	KTI61222	123	KTI70014	60	KTI70188	85
KTI52007	52; 186	KTI62108	124	KTI70015	60	KTI70210	111
KTI52009	52	KTI62110	124	KTI70016	61	KTI70211	110
KTI52107	52; 186	KTI62114	124	KTI70017	60	KTI70212	110
KTI53004	52; 186	KTI62115	125	KTI70018	60	KTI70215	110
KTI53006	52; 186	KTI62116	124	KTI70019	60	KTI70216	110
KTI53006T	52	KTI63100	128	KTI70020	61; 186	KTI70220	111
KTI53008	52; 186	KTI63101	126	KTI70021	60	KTI70300	79
KTI54006	52; 186	KTI63103	128	KTI70022	60	KTI70300-1	79
KTI54010	52; 186	KTI63105	126	KTI70023	60; 186	KTI70300-10	79
		KTI63121	128	KTI70024	60; 186	KTI70300-11	79

Part #	Page #	Part #	Page #	Part #	Page #	Part #	Page #
KTI70300-12	79	KTI70720	72	KTI71724	55; 186	KTI72130	95
KTI70300-2	79	KTI70721	72	KTI71725	55; 186	KTI72132	95
KTI70300-3	79	KTI70722	72	KTI71732	55; 186	KTI72133	95
KTI70300-4	79	KTI70723	72	KTI71733	55	KTI72134	95
KTI70300-5	79	KTI70724	72	KTI71751	55; 186	KTI72135	95
KTI70300-6	79	KTI70725	72	KTI71771	55	KTI72138	95
KTI70300-7	79	KTI70726	72	KTI71782	55	KTI72140	94
KTI70300-8	79	KTI70727	72	KTI71783	55; 186	KTI72141	94
KTI70300-9	79	KTI70728	72	KTI71910	35; 89	KTI72142	94
KTI70301	80; 189	KTI70730	72	KTI71920	35; 88	KTI72143	94
KTI70302	80; 189	KTI70731	72	KTI71921	35; 88	KTI72145	94
KTI70303	80; 189	KTI70732	72	KTI71922	35; 88	KTI72175	94
KTI70304	80; 189	KTI70750	70	KTI71923	35; 88	KTI72176	94
KTI70305	80; 189	KTI70816	67	KTI71924	35; 88	KTI72180	5
KTI70306	80; 189	KTI70900	68	KTI71925	35; 88	KTI72200	72
KTI70311	81; 187	KTI70901	68	KTI71926	35; 88	KTI72205	72
KTI70312	81; 187	KTI70903	68	KTI71927	35; 88	KTI72250	73
KTI70313	81; 187	KTI70904	68	KTI71930	96	KTI72261	89
KTI70321	81; 187	KTI70905	68	KTI71931	96	KTI72310	65
KTI70322	81; 187	KTI70909	68	KTI71932	96	KTI72320	65
KTI70323	81; 187	KTI70910	69	KTI71933	96	KTI72330	65
KTI70330	79; 187	KTI70915	69	KTI71934	96	KTI72340	65
KTI70343	82	KTI70920	69	KTI71940	89	KTI72345	65
KTI70344	82; 187	KTI70921	69	KTI71980	89	KTI72355	64
KTI70348	79; 189	KTI70922	69	KTI71981	98	KTI72355-1	64
KTI70350	79	KTI70999	69	KTI71982	98	KTI72380	64
KTI70355	82	KTI71000	146	KTI71989	97	KTI72450	118
KTI70356	82	KTI71025	144	KTI71990A	96	KTI72451	118
KTI70360	82	KTI71100	70	KTI71991	97	KTI72460	118
KTI70365	82; 187	KTI71103	70	KTI71992	97	KTI72465	118
KTI70370	83	KTI71105	70	KTI71993	97	KTI72505	54; 186
KTI70371	83	KTI71106	70	KTI71996	98	KTI72512	54; 186
KTI70372	83	KTI71108	70; 149	KTI71997	98	KTI72514	54; 186
KTI70375	83	KTI71200	145	KTI71999	96	KTI72523	54; 186
KTI70380	83	KTI71300	144	KTI72000	146	KTI72543	54; 186
KTI70382	83	KTI71301	144	KTI72001	146	KTI72553	54; 186
KTI70383	83; 187; 189	KTI71303	144	KTI72002	146	KTI72610	59
KTI70384	83; 187; 189	KTI71306	144	KTI72003	146	KTI72612	59
KTI70390	86	KTI71400	50; 188	KTI72004	146	KTI72616	59
KTI70390KIT	86	KTI71420	50; 188	KTI72005	146	KTI72625	59
KTI70391	86	KTI71425	50	KTI72006	146	KTI72765	71
KTI70392	86	KTI71475	50; 188	KTI72007	146	KTI72770	71
KTI70393	86	KTI71480	50; 188	KTI72008	146	KTI72771	71
KTI70394	86	KTI71501	84	KTI72010	146	KTI72780	71
KTI70395	86	KTI71502	84	KTI72011	146	KTI72781	71
KTI70396	86	KTI71519	84	KTI72012	146	KTI72782	71
KTI70397	86	KTI71550	84	KTI72014	146	KTI72790	71
KTI70440	66	KTI71555	84	KTI72015	146	KTI72791	71
KTI70450	66	KTI71556	84	KTI72025	146	KTI72792	71
KTI70461	66	KTI71600	7	KTI72035	146	KTI72801	64
KTI70500	84	KTI71606	7	KTI72050	146	KTI72802	64
KTI70510	84	KTI71612	7	KTI72100	94	KTI72900	56; 186
KTI70540	61	KTI71616	7	KTI72101	94	KTI72901	56; 186
KTI70541	61	KTI71620	7	KTI72102	94	KTI72901K	56
KTI70545	61	KTI71700	35; 186	KTI72117	94	KTI72911	56; 186
KTI70546	61; 62	KTI71704	55	KTI72118	94	KTI72912	56; 186
KTI70550	65	KTI71708	55; 186	KTI72120	94	KTI72913	56; 186
KTI70551	65	KTI71714	55	KTI72121	94	KTI72914	56; 186
KTI70600	70	KTI71715	55; 186	KTI72125	94	KTI72915	56; 186
KTI70715	66	KTI71716	55; 186	KTI72126	94	KTI72916	56; 186

Index by Part Number

Part #	Page #	Part #	Page #	Part #	Page #	Part #	Page #
KTI72921	56; 186	KTI73373	106	KTI73813	58	KTI74956	114
KTI72922	56; 186	KTI73374	106	KTI73814	58	KTI74957	115
KTI72923	56; 186	KTI73375	104	KTI73830	58	KTI74958	115
KTI72924	56; 186	KTI73379	101	KTI73831	58	KTI74959	114
KTI72925	56; 186	KTI73380	100	KTI73832	58	KTI74961	114
KTI72931	56; 186	KTI73381	100	KTI73833	58	KTI74971	115
KTI72932	56; 186	KTI73386	105	KTI73834	58	KTI74981	115
KTI72980	56	KTI73387	107	KTI73849	58	KTI75105	117
KTI72982	56; 186	KTI73388	107	KTI73850	58	KTI75140	116
KTI72984	56; 186	KTI73389	108	KTI73851	58	KTI75141	116
KTI72986	56; 186	KTI73393	106	KTI73861	58; 186	KTI75142	116
KTI72988	56; 186	KTI73394	106	KTI73862	58; 186	KTI75143	116
KTI73000	56; 186	KTI73396	107	KTI73864	58; 186	KTI75145	116
KTI73012	56; 186	KTI73397	107	KTI73870	58; 186	KTI75146	117
KTI73016	56; 187	KTI73398	108	KTI73871	58; 186	KTI75201	85
KTI73020	56; 187	KTI73399	107	KTI73873	58; 186	KTI75202	85
KTI73024	56; 187	KTI73400	65	KTI73900	73	KTI75300	163
KTI73028	56; 187	KTI73510	59	KTI74005	61	KTI75305	163
KTI73102	62	KTI73550	59	KTI74010	61	KTI75306	64
KTI73103	62	KTI73560	59	KTI74015	61	KTI75310	70
KTI73104	62	KTI73600	76; 189	KTI74020	61	KTI75311	70
KTI73104-1	62	KTI73601	76; 189	KTI74025	61	KTI75312	70
KTI73105	62	KTI73602	76; 189	KTI74030	61	KTI75320	70
KTI73150	62	KTI73603	76; 189	KTI74103	61	KTI75321	70
KTI73155	62	KTI73605	76; 189	KTI74106	61	KTI75322	70
KTI73201	66	KTI73606	76; 189	KTI74107	61	KTI75323	70
KTI73202	66	KTI73607	77	KTI74108	61	KTI75324	70
KTI73303	102	KTI73608	77	KTI74308	111	KTI76000	148; 186
KTI73304	103	KTI73609	77	KTI74500	112	KTI76004	148
KTI73305	103	KTI73610	77	KTI74505	112	KTI76040	148; 186
KTI73306	103	KTI73611	77	KTI74510	112	KTI76070	148; 186
KTI73307	104	KTI73612	77	KTI74521	112	KTI76110	148; 186
KTI73311	103	KTI73613	76; 189	KTI74523	112	KTI76140	148; 186
KTI73312	103	KTI73613N	77	KTI74524	112	KTI76145	148; 186
KTI73315	102	KTI73614	76; 189	KTI74530	112	KTI76180	148
KTI73318	102	KTI73615	76; 189	KTI74535	111	KTI76240	148
KTI73330	102	KTI73616	76; 189	KTI74536	111	KTI76360	148
KTI73333	102	KTI73617	77	KTI74537	111	KTI77070	148; 186
KTI73335	102	KTI73618	76; 189	KTI74538	111	KTI77140	148; 186
KTI73340	100	KTI73619	76; 189	KTI74601-12	73	KTI78004	148
KTI73341	100	KTI73620	75; 189	KTI74601-1	73	KTI78040	148; 186
KTI73342	100	KTI73621	75	KTI74602-12	73	KTI78070	148; 186
KTI73343	100	KTI73623	77	KTI74602-1	73	KTI78110	148; 186
KTI73345	100	KTI73624	77	KTI74603	75	KTI78140	148; 186
KTI73346	100	KTI73625	77	KTI74604	75	KTI78145	148; 186
KTI73348	100	KTI73626	77	KTI74605	74	KTI78180	148
KTI73349	103	KTI73627	77	KTI74606	74	KTI78240	148
KTI73350	103	KTI73628	77	KTI74607	74	KTI78360	148
KTI73351	103	KTI73630	77	KTI74608	74	KTI79100	64
KTI73355	103	KTI73635	77	KTI74609	74	KTI79110	64
KTI73356	103	KTI73701	70	KTI74611	74	KTI79200	144
KTI73357	103	KTI73701-50	70	KTI74612	74	KTI79201	144
KTI73358	101	KTI73730	75; 189	KTI74613	74	KTI79205	144
KTI73359	101	KTI73731	75; 189	KTI74630	75	KTI79210	144
KTI73360	101	KTI73801	58; 186	KTI74640	74	KTI79215	144
KTI73362	101	KTI73802	58; 186	KTI74641	74	KTI79216	144
KTI73363	101	KTI73803	58; 186	KTI74650	73	KTI79217	144
KTI73370	104	KTI73810	58	KTI74651	73	KTI79220	144
KTI73371	104	KTI73811	58	KTI74900	115	KTI79225	144
KTI73372	104	KTI73812	58	KTI74951	114	KTI79800	108

Part #	Page #	Part #	Page #	Part #	Page #	Part #	Page #
KT179801	108	KT185807	139	KT1OLF-04333	182; 183; 184; 185; 186; 187; 188; 189; 190	ACC10-0455	92
KT180955	140	KT185811	143	KTU0805	176	ACC10-3898	91; 92; 93
KT180989	143	KT185846	139	KTU0806	176	ACC10-3899	91; 92; 93
KT180995	140	KT187125	137	KTU0807	176	ACC20-3045	93
KT180996	143	KT187126	137	KTU0808	176	ACC20-3100	92
KT180998	140	KT187128	137	KTU0809	176	ACC20-3345	93
KT181380	141	KT187130	136	KTU0810	177	ACC20-3360	93
KT181550	134	KT187132	137	KTU0811	177	ACC20-3900	93
KT181560	134	KT187140	144	KTU0812	177	ACC20-3901	93
KT181565	134	KT187141	144	KTU0813	178	ACC20-3902	93
KT181622	134	KT188255	138	KTU0814	178	ACC20-3903	93
KT181631A	134	KT189001	95	KTU0815	178	ACC20-3904	93
KT181632A	134	KT189002	95	KTU0816	178	ACC20-3908	92; 93
KT181772A	135	KT189003	95	KTU0817	178	ACC20-3909	92; 93
KT181774	135	KT189110	138	KTU0819	179	ACC20-3910	92; 93
KT181775	135	KT189115	138	KTU0820	179	ACC20-3911	92
KT181795	135	KT189191	143	KTU0821	179	ACC20-3914	93
KT181900	142; 187	KT189193	143	KTU0822	179	ACC20-3918	92; 93
KT181956	142; 187	KT189194	143	KTU0831	179	ACC20-3919	92; 93
KT181958	142; 187	KT189218	138	KTU0832	179	ACC20-3920	92; 93
KT181959	142; 187	KT189220	138	KTU0833	180	ACC20-3921	92; 93
KT181968	142; 187	KT189275	137	KTU0834	180	ACC20-4000	92
KT181972	142; 187	KT189302	140			ACC20-4100	92
KT181973	142; 187	KT190002	59			ACC20-4155	93
KT181974	142	KT190003	59			ACC2597Y1290	93
KT181975	142; 187	KT1H00K11	182; 184; 185; 187; 188; 189; 190				
KT181976	142; 187	KT1H00K2	182; 183; 184; 185; 186; 187; 188; 189; 190				
KT181977	142	KT1H00K3	182				
KT181979	142; 187	KT1H00K8	184; 190				
KT181981	142; 187	KT1OL0805	182				
KT181982	142; 187	KT1OL0806	182				
KT181986	142	KT1OL0807	183				
KT181995	142; 187	KT1OL0808	184				
KT181996	142; 187	KT1OL0809	184				
KT181997	142; 187	KT1OL0810	184				
KT182500A	133	KT1OL0811	185				
KT182503A	133	KT1OL0812	185				
KT182504	133	KT1OL0813	185				
KT183090	142	KT1OL0814	185				
KT183091	142; 187	KT1OL0815	186				
KT183092	142; 187	KT1OL0816	186				
KT183093	142; 187	KT1OL0817	186				
KT183275	136	KT1OL0819	186				
KT183277	136	KT1OL0820	186				
KT183280	137	KT1OL0821	186				
KT184218	136	KT1OL0822	186				
KT184228	136	KT1OL0831	187				
KT184229	136	KT1OL0832	187				
KT185003	143	KT1OL0833	187				
KT185004	143	KT1OL0834	188				
KT185005	143	KT1OL0835	188				
KT185006	143	KT1OL0836	188				
KT185007	143	KT1OL0837	189				
KT185008	143	KT1OL0838	189				
KT185265	139	KT1OL0839	190				
KT185695	143	KT1OL0840	190				
KT185696	143	KT1OL0842	190				
KT185697	143						
KT185746	139						
KT185800	139						

ACCUTORQ

ACC10-0103	92
ACC10-0304	90; 91; 93
ACC10-0305	90; 91; 93
ACC10-0306	90; 91; 93
ACC10-0307	90; 91; 93
ACC10-0308	90; 91; 93
ACC10-0309	93
ACC10-0310	90; 91; 93
ACC10-0311	90; 91; 93
ACC10-0312	90; 91; 92; 93
ACC10-0313	90; 91; 92; 93
ACC10-0314	90
ACC10-0315	90
ACC10-0317	90
ACC10-0319	90
ACC10-0321	91
ACC10-0322	91
ACC10-0323	91
ACC10-0324	91
ACC10-0326	91
ACC10-0327	91; 93
ACC10-0328	91; 92; 93
ACC10-0329	91; 93
ACC10-0334	91; 93
ACC10-0335	93
ACC10-0336	91; 93
ACC10-0337	93
ACC10-0338	93
ACC10-0339	93
ACC10-0340	91; 93
ACC10-0341	91; 93
ACC10-0342	91; 93
ACC10-0343	91; 93
ACC10-0450	92

GLASSMASTER

KTD72004	67
KTD72502	67
KTD74003	67
KTD74004	67
KTD74503	67
KTD76003	67
KTD76503	67
KTD77601	67
KTD77604	67
KTD77621	67
KTD77622	67

MAG-CLIP

MCP72400	119
MCP72401	119
MCP72402	119
MCP72403	119
MCP72404	119
MCP72405	119
MCP72421	118
MCP72422	118
MCP72423	118
MCP72424	119
MCP72425	119
MCP72426	119
MCP72441	119
MCP72442	119
MCP72443	119
MCP72453	119
MCP72455	119
MCP72460	119

Index by Category

Index by Category

A

A/C O-Ring	151
Abrasive Discs	143
Adapters and Reducers	18, 34
Adhesives	59
Adjustable Wrenches	48
Air Cut Off Tool	138
Air Die Grinders	137
Air Drills	136
Air Hammer Bit Retainers	142
Air Hammers	136
Air Hoses	146
Air Impacts	134, 135
Air Ratchets	133
Air Regulator	143
Air Riveters	138
Air Sanders/Polishers	139
Air Shears	138
Air Tool Accessories	143
Allen Hex Keys	50
Angle Grinder	141
Antifreeze Tester	110
Automatic Center Punch	56
Awl	65

B

Ball Joint Service Kit	84
Ball Joint Tools	84
Ball Pein Hammer	55
Barrel Pump	72
Battery Booster Cables	112
Battery Cable Ends	111
Battery Terminal Brush	111
Battery Terminals	150
Battery Tester	110, 111
Bearing Separators	83
Bench Grinder	121
Bench Vises	121
Bits - Drill	7, 145
Bits - Screwdriver	6
Bleeder Screw Kit	166
Body Clip Plier	70, 148
Bolt Cutter	63
Bottle Jacks	121, 122
Brake Adapter Kits	166
Brake Bleeder	89
Brake Line	158
Brake Line Fittings and Adapters	158, 159, 160
Brake Tools	88, 89
Brass Hammers and Punches	55
Breaker Bar (Flex Handles)	20
Brushes	61
Budd Wheel Sockets	34

B Continued

Bulbs - Replacement	104
Butane Fuel	66
Butane Torches	85
Butt Connectors	165

C

C-Clamps	53, 85
Cables - Battery	112
Cable Cutters	52
Caliper (digital)	67
Car Dollies	131
Carts - Service/Utility	116, 117
Child Safety Blanket	66
Chisels	56
Circuit Testers	71
Combination Wrenches	37 to 40, 43, 44, 46
Cotter Pin Kits	171
Cranes	125
Creepers	114, 115
Crimping Tools	149
Crowfoot Wrenches	21
Cup Brushes	144
Cut Off Arbor	144
Cut Off Wheels	144

D

Dent Puller Kits	84, 140
Diagonal Cutters	52
Disc Brake Piston Tool	88
Disconnect Tools/ Kits	70, 171
Displays	176 to 181, 192
Distributor Wrench	70
Drain Pan	74
Drain Plug Gaskets	157, 167
Drain Plugs	157
Drill Bits	7, 145
Drip Tray	74
Drum Bung Wrench	49

E

E-clip Kit	171
Electric Impact	141
Electrical and Hardware Kits	165
Electrical Connectors	154
Electrical Terminals	154, 155
Electrical Wire	150, 151
Engine Cranes	125
Engine Stands	124
Engine Sling	125
Engine Support Bars	124

Index by Category

E Continued

Extension Cords	100
Extensions	19, 35
External Torx Sockets	16, 21, 22
Extractor Set	66

F

Fender Covers	66
Files	54
Flare Nut Wrenches	42
Flares	108
Flaring Tool	78, 79
Flex Handles	20
Fluid Measuring	73
Fluorescent Lights	102, 103
Fuel Line and Components	160, 161, 162, 163
Fuel Line Assembly Tools	163
Funnels	73, 74, 75
Fuse Kits	164, 172
Fuses/Fuse Tools	151, 152, 153

G-H

Glass Cleaning Tool	67
Grease Fittings	156, 167
Grease Gun - Air Operated	73
Hacksaws	64
Halogen Lights	104
Hammers	55
Harmonic Balancer	82
Headlamp Light	108
Heat Blankets	66
Heat Shrink Tubing	155, 174
Heating Element Socket	28
Hex Keys	50
Hitch Pin Kit	171
Hose Clamp	70, 149
Hose and Pipe Cutter	64
Hydraulic Jacks	122
Hydraulic Presses	131
Hydraulic Ram	125, 130

I-J

Impact Driver	35
Impact Socket Sets	21, 22, 29 to 34
Impact Sockets	13 to 18
Impact Wrenches	134, 135
Inspection Light	108
Jacks - Hydraulic	12
Jack Stands	123
Jacks - Scissor	129
Jacks - Transmission	129

K

Kneeling Pad	115
Knives - Folding	62
Knives - Putty	60
Knives - Utility	62

L

LED Lighting	106, 107, 108
Letter Stamps - Metal	65
Lighting	101 to 103
Lighting Accessories / Parts	103
Lights - Fluorescent	102, 103
Lights - Halogen	104
Lights - Headlamp	108
Lights - LED	106, 107, 108
Lights - Replacement Parts	103
Lights - Trouble	101, 102
Lights - Underhood	105
Load Tester	111
Locking Pliers	53
Long Ram Jacks	125, 130
Lug Nut Remover Kit	89
Lug Wrenches	89

M

Magnet - Telescoping	68, 69
Magnetic Parts Tray	69
Magnetic Tool Organization	118, 119
McPherson Strut Tools	83
Memory Saver	111
Mini Pick Sets	65
Mirrors - Telescoping	69
Monkey Wrenches	48

N

Needle Nose Pliers	52
Needle Scaler	137
Number Stamps - Metal	65
Nut Drivers	6
Nut Splitter	66
Nylon Hose	144
Nylon Ties/Tools	148

O

O-Ring Assortments	173
Oil Filter Cap Sockets	76, 77
Oil Filter Pliers	75
Oil Filter Wrenches	75, 76, 77
Organization - Magnetic Tool	118, 119
Oxygen Sensor Socket	35

Index by Category

Index by Category

P

Pallet Jack	131
PBE Tools	138 to 140
Picks	65
Pick-Up Tools	68, 69
Pilot Bearing Tools	82
Pinch Off Pliers	70
Pipe and Hose Cutter	64
Pipe Wrenches	49
Pitcher	73
Pitman Arm Puller	82
Pliers / Pliers Sets	52 to 54
Pliers - Body Clip	70, 148
Pliers - Hose Clamp	70, 149
Pliers - Locking	53
Pliers - Needle Nose	52
Pliers - Pinch Off	70
Pliers - Slip Joint	52
Pliers - Snap Ring	54
Pneumatic Bits	142
Polisher - Orbital Waxer	141
Presses - Hydraulic	131
Pry Bars	7
Pullers	79 to 82
Punches and Chisels	56
Putty Knives	60

Q

Q-Bond	59
--------	----

R

Ram - Hydraulic	125, 130
Ratcheting Box Wrenches	39, 41, 45, 47
Ratcheting Tie Downs	58
Ratcheting Wrenches	39 to 40, 45, 47
Ratchets	19, 20
Ratchets - Flex Handle	20
Ratchets - Sliding Handle	20
Ratchets - Speed Handle	20
Ratchets - Spinner Handle	20
Reducers and Adapters	18, 34
Reels - Cord	100, 102
Retrievers - Magnetic	68
Rivet Gun	138
Rivet Tools	64
Rubber Mallet	55
Rubber Straps	58

S

Safety Flares	108
Sanders	139

S Continued

Sander Pads	143
Sanding Pen	65
Saws	64
Scissor Jacks	129
Scrapers	60, 61
Screw Extractors	66
Screwdriver Bits	6
Screwdrivers	4, 5, 6
Screwdrivers - Torque	5, 6
Seats - Creeper	115
Separators	84
Serpentine Belt Tool	72
Service/Utility Carts	116, 117
Service Jack	126, 127, 128
Shop Presses	131
Shrink Tube Kits	174
Shrink Tubing	155, 174
Siphon Pump	73
Slide Hammer Set	82, 84, 86
Sliding T-Handle	20
Snap Ring Kits	54, 171
Snap Ring Pliers	54
Socket Sets - Chrome	21 to 27
Socket Sets - Impact	21, 22, 29 to 34
Sockets - Brake Caliper	17
Sockets - Budd Wheel	34
Sockets - Chrome	9 to 12, 17, 18
Sockets - Flex	29, 30, 32
Sockets - Heating Element	28
Sockets - Hex	16, 17
Sockets - Impact	13 to 18
Sockets - Oxygen Sensor	35
Sockets - Stud	28
Sockets - Torq	17, 21, 22
Sockets - Torx	16, 21, 22
Spark Plug Extractors	85
Spark Plug Gauge	70
Spark Plug Sockets	35
Specialty Kits	167
Spindle Adapters	144
Spindle Nut Sockets	28
Sliding Handle	20
Speed Handle	20
Spinner Handle	20
Spray Gun Accessories	143
Spray Guns	140
Spring Compressors	83
Steel Line Stopper Kit	64
Steering Wheel Puller	79
Stretch Belt Tools	72
Stretch Cords	58
Strut Compressor	83

Index by Category

T

Tamper Proof Torx	18, 22
Tape - Electrical, Duct, Pipe Thread	59
Tape Measures	59
Testers - Circuit	71
Tie Downs	58
Tie Rod Tools	84
Tin Snips	64
Tire Inflator/Gauge	95
Tire Repair	96
Tire Wrench 4-way	89
Tool Cart / Service Cart	116, 117
Torches	85
Torch Shield	66
Torq Screwdrivers	98
Torque Adapter	95
Torque Limiting Sockets	90, 91, 92, 93
Torque Wrenches	94, 95
Torx Socket Sets	16, 21, 22
Tow Ropes, Straps	58
Towing	58
TPMS Tools and Accessories	96, 97, 98
Transmission Jacks	129
Trolley Jacks	128
Trouble Lights	101, 102
Truck Jack	127
Tubing Bender	65
Tubing Cutters	65

U-V

Underhoist Stand	123
Underhood Lights	105
Universal Joints	18, 34
Upholstery Remover	61
Utility/Service Carts	116, 117
Utility Cutter	62
Vacuum Tees	156, 167
Vises	121

W

Washer Kits	173
Welding Blanket	66
Wheel Bearing Locknut Set	88
Windshield Knife	61
Windshield Removing Tool	61
Wire	150, 151
Wire Connectors	150, 154, 155
Wire Looms	150
Wire Strippers	149
Wire Ties	148
Wire Wheels	144
Worklights	105, 106

W Contiued

Wrenches	35 to 49
Wrench - Combination	37 to 40, 43, 44, 46
Wrench - Distributor	70
Wrench - Drum Bung	49
Wrench - Lug	89
Wrench - Monkey	48
Wrench - Pipe	49
Wrench - Ratcheting	39 to 40, 45, 47
Wrench - Ratcheting Box	39, 41, 45, 47
Wrench - Tire 4-way	89
Wrenches - Torque	94, 95

WARRANTY POLICY

Hand Tools - Lifetime Warranty

K-Tool International Hand Tools are warranted against defects in material or workmanship for the life of the tool.

Improper use of a tool will void its warranty. Exceptions to this warranty are as follows:

KTI Hand Tools	Lifetime warranty. Excludes adapters.
TMPS Tools (Sensor Activation Tools)	3-year, repairable item.
KTI Torque Wrenches - U.S.-made	1-year, repairable item.
KTI Torque Wrenches - Digital and Import	90-day limited, repairable item. 1/2 price replacement option after 90 days.
KTI Lighting	1-year warranty. Bulbs are not covered.
KTI Pullers - U.S.-made and Import	Limited lifetime on parts. Will not warrant entire tool, credit issued for defective part.
KTI "Standard Duty" Lifting Equipment	1-year repair or replace.
KTI "Professional" & "Heavy Duty" Lifting Equipment (XD & HD Series)	2-year repair or replace.
Vises	10-year limited warranty.
Battery Chargers	1-year repair or replace, 5-year warranty on transformer and rectifier.
Battery Boosters and Testers	1-year repair or replace.
Electrical	1-year limited warranty.
Air Hoses	90-day limited warranty. Complete hose must be returned for credit.
Mega Hammer	1-year warranty.
Creepers	90-day warranty.
Test Equipment	90-day limited warranty.
Expendibles, Non-metal Products	Not covered.
Repair Parts	Not covered.
KTI Air Tools	1-year limited warranty with 30-day* over-the-counter replacement.

K-Tool International air tools are warranted against defects in workmanship for one year from the date of purchase*.

We will repair or replace, at our option, any defective part or unit which proves to be defective in material or workmanship within the warranty period. Should an air tool fail within the first 30 days after purchase date, it may be returned to the place of purchase for a free replacement*. The foregoing obligation is K-Tool International's sole liability under this or any implied warranty, and under no circumstances, shall it be liable for any incidental or consequential damages. This warranty applies to the basic tool. It does not apply to normal wear and tear on attached accessories/consumable products such as drill chucks, backing pads for sanders, punch and die for nibblers, air hammer retainers, spray gun cups, or "kit" accessories, etc. Warranty repair will not be performed on a spray gun that has not been cleaned. It must be cleaned before it is sent in for repair or spray gun will be returned collect with no repairs performed. Repairs required as a result of abuse, misuse, damage or repair attempts made by others are not covered by this warranty. **Do NOT, under any circumstances, attempt to repair or make any adjustments on your tool, as this will VOID your warranty.**

**All returns on noted exceptions must be accompanied by a sales receipt.
Should you experience a problem within your warranty period, ship prepaid to:**

**WARRANTY CENTER
31133 Wixom Road, Wixom, Michigan 48393**



AIR TOOL WARRANTY POLICY

ONE (1) YEAR LIMITED WARRANTY

*30 day over-the-counter replacement

Requirements for all warranty repairs:

- Proof of purchase - Sales receipt must accompany all repairs.
- Warranty card must be on file within 30 days from date of purchase.

K-Tool International air tools are warranted against defects in workmanship for one (1) year from the date of purchase*. We will repair or replace, at our option, any defective part or unit which proves to be defective in material or workmanship within the warranty period. Should an air tool fail within the first 30 days after purchase date, it may be returned to the place of purchase for a free replacement*. The foregoing obligation is K-Tool International's sole liability under this or any implied warranty, and under no circumstances, shall it be liable for any incidental or consequential damages.

This warranty applies to the basic tool. It does not apply to normal wear and tear on attached accessories/consumable products, such as drill chucks, backing pads for sanders, punch and die for nibblers, air hammer retainers, spray gun cups or "kit" accessories, etc.

*Repairs required as a result of abuse, misuse, damage or repair attempts made by others are not covered by this warranty.

Do NOT, under any circumstances, attempt to repair or make any adjustments on your tool, as this will VOID your warranty.

Suggested instructions for maximum air tool efficiency:

- Your tool should be oiled daily when in use with a non-detergent type oil. Manufacturer recommends 4 - 5 drops of type "A" transmission oil or air tool oil be applied through the rear inlet. If possible, a fog type oiler is recommended.
- Check your compressor daily for excess water. Moisture greatly affects the efficiency of tool operation and may void warranty.
- Use recommended air pressure (not to exceed 90 psi). For maximum performance, air compressor must be capable of maintaining approximately 90 psi.
- 3/8" air hose and fittings are recommended for optimum operation of tools. 1/2" air hose for 3/4" or 1" impact wrenches is required to maximize performance.
- An oil/water extractor is necessary for spray guns.

Notice: Warranty repair will not be performed on a spray gun that has not been cleaned. Item must be cleaned before it is sent for repair, or spray gun will be returned collect, with no repairs performed.

Should you experience a problem within your warranty period, ship prepaid to:

WARRANTY CENTER
31133 Wixom Road, Wixom, Michigan 48393

Safety Information

Safety Information

For your safety, please read and understand the following safety guidelines.

Never misuse a tool. Improper use of a tool will shorten its life.

ALWAYS wear safety goggles to protect eyes. Keep your tools clean.

Never use a broken tool. Keep all tools out of the reach of children.

AccuTorq®:

Wear protective goggles. Never hold with hands while tightening. Never use torque sockets to remove lug nuts. When tightening lug nuts, use the criss-cross wheel nut tightening sequence.

Battery Chargers:

Wear protective goggles. Charger must be OFF when connecting or disconnecting leads. Do not smoke, strike a match or cause a spark in vicinity of battery during charging. All clamps and connections should be tight and clean. Replace defective cords and wires immediately. Do not start car with charger clips connected to battery.

Grinders, Grinding Wheels and Air Tool Accessories:

Wear protective goggles. Do not operate power tools at speeds that exceed their maximum rated rpm. Power tool accessories can break, causing particles to fly. Avoid injury by using eyeshields and guards.

Hammers:

Wear protective goggles. Always use a hammer that is suitable for the job. Head diameter should always exceed the object being struck, such as a punch or chisel. Do not strike a tool that shows distress.

KTip.s.t.® TPMS Activation Tool

Product emits magnetic and electromagnetic waves that may interfere with the safe operation of pacemakers. Individuals who have pacemakers should never use this product. Do not use any harsh chemical solvents to clean tool. Do not use tool where contact or immersion in water is possible. Never spill liquid of any kind on the tool. Do not use or store the tool where it is exposed to direct sunlight or excessive moisture. Do not operate tool in the vicinity of open containers or flammable liquids. Do not operate tool with battery cover removed.

Lifting Equipment:

Do not exceed the rated capacity of jack or jack stands. Use jacks only on strong level surfaces. Collapse of lifting equipment can cause serious injury. Do not work on a vehicle supported by a jack, use jack stands.

MEGAHAMMER®:

Lock nut on hub removal tool must be tight to protect against thread damage. Slide shaft thread to be engaged into base plate thread so it is flush with inside edge of base plate thread. Use countersunk holes ONLY for proper grip on studs. Use outboard support to help prevent tool and wheel assembly from dropping to floor. Do not stand behind tool when in use. Tool is heavy. Use extreme caution when lifting. Keep extremities clear of pinch points. Always wear eye protection when using hub removal tool. Locking pin must be in place when not in use. Not responsible for damage to vehicle.

Pliers:

Wear protective goggles. Broken tips or cut material can fly.

Power Tools:

Wear protective goggles. Always read instructions before using a power tool. Flying particles can cause injury. Use hearing protection when exposed to noise for prolonged periods of time. Do not misuse power tools.

Prybars:

Wear protective goggles. Do not strike a prybar. Prybars may cause loose material to fly. Do not use if chipped or cracked.

Pullers:

Wear protective goggles. Be sure that center screw threads are clean and well lubricated. Be sure the puller is seated properly, do not use on an angle. Do not overstress the puller, always use the largest size possible to do the job efficiently. Never use a puller with worn or damaged parts.

Punches/Chisels:

Always wear protective goggles. Regrind a dull chisel to its original shape when the cutting edge becomes dull. Use a punch or chisel holder to prevent injury. Never use a broken punch or chisel.

Ratchets:

Ratchet mechanism may slip or break if parts are worn or dirty. Frequently clean and lubricate.

Screwdrivers:

Wear protective goggles. Never use a screwdriver for prying, punching, chiseling or scraping. Be sure tip width and thickness are appropriate for slot size.

Sockets (Hand):

Wear protective goggles. Be sure to always choose the appropriate type of socket based on its application. Do not use hand sockets on power tools.

Sockets (Impact):

Wear protective goggles. Flexible sockets and swivel joint tools rotate under power during use and should not be held. Using broken tools can cause serious injury.

Spray Guns:

Wear protective goggles.

Tie Downs/Stretch Cords:

Wear protective goggles when stretching, fastening or releasing hooks. A rebounding hook is dangerous. Do not use if product appears frayed or worn, or if the hook has been bent or otherwise tampered with. Do not stretch a stretch cord beyond 50% of its unstretched length. Do not expose to extreme stress or incorrect use. Do not exceed the maximum working load.

Tow Straps/Ropes:

Do not expose to extreme stress or incorrect use. Working load requirement should be evaluated by user before choosing the appropriate assembly. Always check anchor points. Never use if webbing is worn or frayed.

Wrenches:

Wear protective goggles. Do not over-torque. Avoid excess force on crowfoot or flare nut wrenches. Always use correct size.

K-Tool International

Wixom, MI 48393

www.ktoolinternational.com

Part No. KTI-CAT



Serving the Automotive Industry Since 1984

2015